

**16 CHAR.
1 LINE**

OPTIONS

- * LCD PANEL
TN or STN
- * View Angle
12H or 6H
- * Character
Eng/Jan
Eng/Rus
Eng/Eur

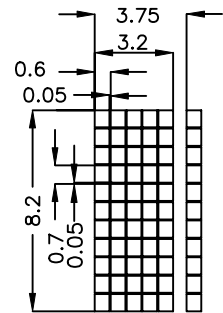
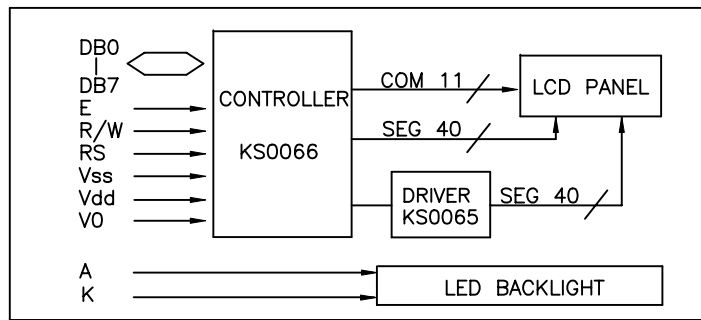
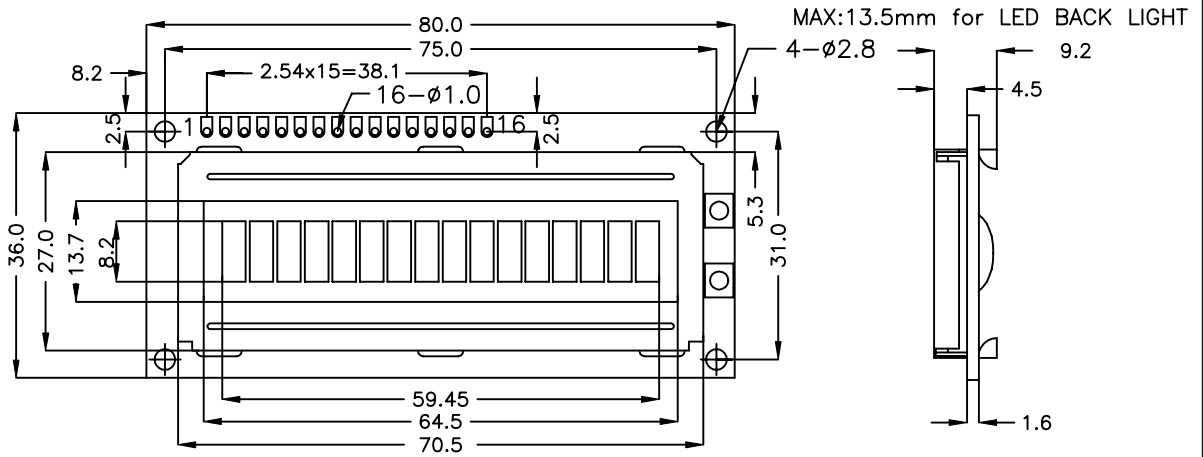

All dimensions in mm. Tolerance ± 0.3 mm unless otherwise specified.

MECHANICAL SPECIFICATIONS

ITEM	SPECIFICATION	UNIT
Overall Size	80.0Wx36.0Hx9.2T(BL13.5T)	mm
Viewing Area	64.5Wx13.7H	mm
Character Number	16Wx1H	
Character Size	3.2Wx8.2H	mm
Character Pitch	3.75Wx8.2H	mm
Dot Size	0.6Wx0.7H	mm

PIN ASSIGNMENT

PIN	SYMBOL	FUNCTION
1	Vss	Power Supply(GND)
2	Vdd	Power Supply(+5V)
3	Vo	Contrast Adjust
4	RS	Instruction/Data Register Select
5	R/W	Data Read/Write
6	E	Enable Signal
7-14	DB0-DB7	Data Bus Line
15	A	Power Supply for LED BL(+)
16	K	Power Supply for LED B/L(-)

ABSOLUTE MAXIMUM RATINGS

ITEM	SYMBOL	MIN.	MAX.	UNIT
Power Supply (Logic)	Vdd	-0.3	7.0	V
Power Supply (LCD)	Vo	Vdd-15.0	Vdd+0.3	V
Input Voltage	Vi	-0.3	Vdd	V
Operating Temperature	Topr	0	50	°C
Storage Temperature	Tstg	-20	70	°C

ELECTRICAL CHARACTERISTICS(Ta=25°C, Vdd=5V±0.25V)

ITEM	SYMBOL	MIN.	MIN.	MAX.	UNIT
Power Supply(Logic)	Vdd	4.5	5.0	5.5	V
Supply Current	Idd	2.0	—	—	mA
LCD Driving Voltage	Vdd-Vo	—	—	13.0	V
Input Voltage "H"	Vih	2.2	—	Vdd	V
Input Voltage "L"	Vil	—	—	0.6	V
Output Voltage "H"	Voh	2.4	—	—	V
Output Voltage "L"	Vol	—	—	0.4	V

LED BACKLIGHT SPECIFICATIONS

ITEM	TYP.	ITEM	TYP.
Forward Voltage	4.2V	Power Dissipation	756mW
Forward Current	180mA	Emission Wavelength	570nm