

OM5201ST/RT/DT OM5203ST/RT/DT OM5217ST/RT/DT OM5234ST/RT/DT
 OM5202ST/RT/DT OM5216ST/RT/DT OM5233ST/RT/DT

HERMETIC JEDEC TO-257AA HIGH EFFICIENCY, CENTER-TAP RECTIFIER

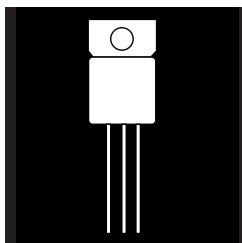

16 Amp, 50 To 600 Volts, 35 To 50 ns trr

FEATURES

- Very Low Forward Voltage
- Very Fast Recovery Time
- Hermetic Metal Package, JEDEC TO-257AA Outline
- Low Thermal Resistance
- Isolated Package
- High Surge
- Available Screened To MIL-S-19500, TX, TXV And S Levels

DESCRIPTION

This series of products in a hermetic package is specifically designed for use at power switching frequencies in excess of 100 kHz. The series combines two high efficiency devices into one package, simplifying installation, reducing heat sink hardware, and the need to obtain matched components. These devices are ideally suited for Hi-Rel applications where small size and a hermetically sealed package is required. Common anode configurations are also available. Common cathode is standard.

ABSOLUTE MAXIMUM RATINGS (Per Diode) @ 25°C

Peak Inverse Voltage	50 to 600 V
Maximum Average D.C. Output Current @ $T_C = 100^\circ\text{C}$	8A
Surge Current (Non-Repetitive 8.3 msec)	60
Operating and Storage Temperature Range	- 55° C to + 150° C

3.2

SCHEMATIC

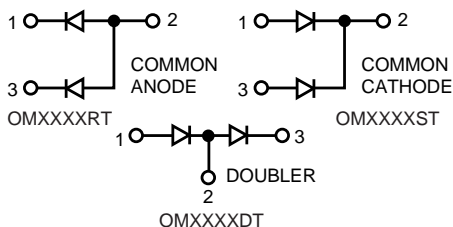

Common cathode is standard. Contact the factory for performance characteristics for common anode and doubler.
 Z-Tab package also available.

MECHANICAL OUTLINE

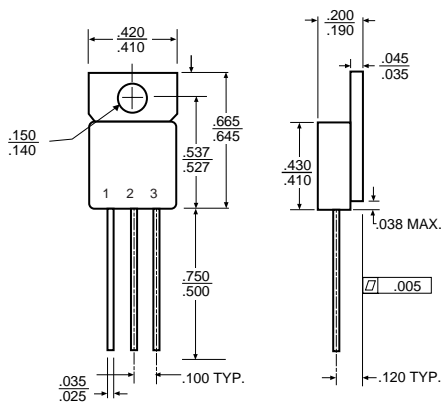

OM5201ST/RT/DT - OM5234ST/RT/DT

ELECTRICAL CHARACTERISTICS (Per Diode)

Type	PIV	Maximum Forward Voltage (Volts) @ (1)		Maximum Reverse Current @ PIV		Maximum Reverse Recovery Time (2)	Maximum Thermal Resist. $R_{\theta JC}$
		$T_J = 25^\circ C$	$T_J = 100^\circ C$	$T_J = 25^\circ C$	$T_J = 100^\circ C$		
OM5201XX	50	1.0V @ 8A	.925V @ 8A	10 μA	500 μA	35 nsec	3.8
OM5202XX	100						
OM5203XX	150						
OM5216XX	200						
OM5217XX	300	1.4V @ 8A	1.1V @ 8A	20 μA	1.0 mA	50 nsec	2.5
OM5233XX	400						
OM5234XX	600	1.55V @ 8A	1.25V @ 8A	20 μA	1.0 mA	50 nsec	

(1) Pulse Test: Pulse Width = 300 μs , Duty Cycle = 2.0%. (2) Measured in Circuit: $I_F = 0.5 A$, $I_R = 1.0 A$, $I_{REC} = 0.25 A$

**50 V TO 200 V
TYPICAL FORWARD VOLTAGE
OM5201, 5202, 5203, 5216**

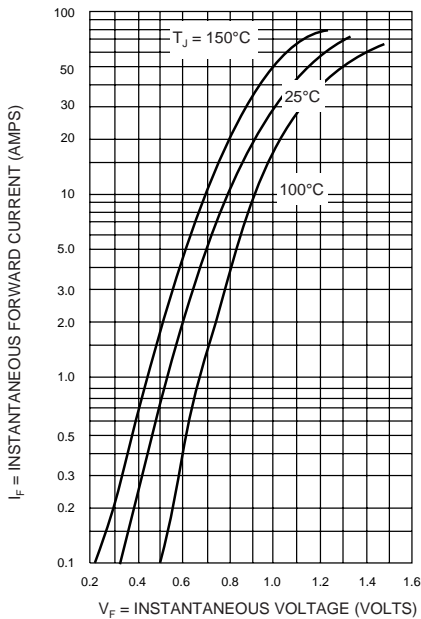

**300 V & 400 V
TYPICAL FORWARD VOLTAGE
OM5217, 5233**

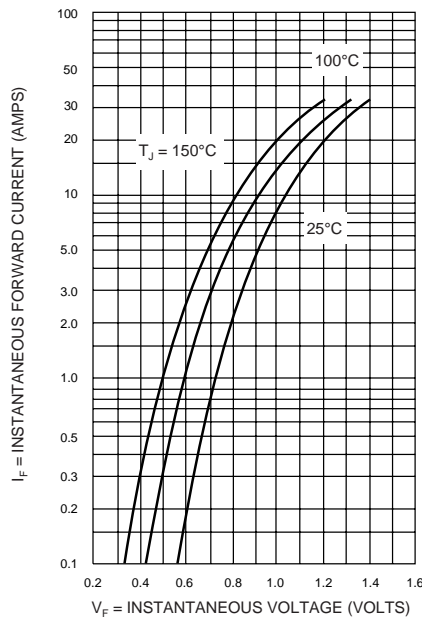

**TYPICAL REVERSE CURRENT
OM5201, 5202, 5203, 5216**

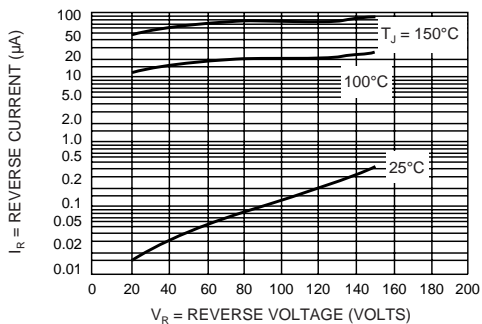

**TYPICAL REVERSE CURRENT
OM5217, 5233**

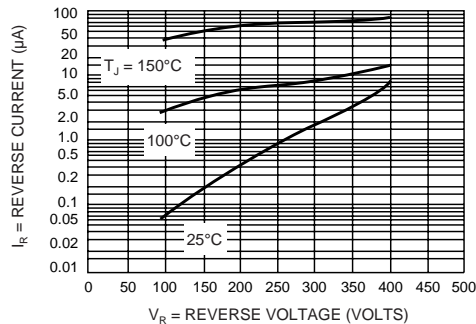

3.2