

FEATURES

- *Guaranteed* $25\mu\text{V}$ max. Offset Voltage
- *Guaranteed* $0.6\mu\text{V}/^\circ\text{C}$ max. Offset Voltage Drift with Temperature
- *Excellent* $1.0\mu\text{V}/\text{Month}$ max. Long Term Stability
- *Guaranteed* $0.6\mu\text{V}_{\text{p-p}}$ max. Noise
- *Guaranteed* 2.0nA max. Input Bias Current

APPLICATIONS

- Thermocouple Amplifiers
- Strain Gauge Amplifiers
- Low Level Signal Processing
- Medical Instrumentation

DESCRIPTION

The OP-07 offers excellent performance in applications requiring low offset voltage, low drift with time and temperature and very low noise. Linear's OP-07 is interchangeable with many of the precision op-amp device types. The OP-07 also offers a wide input voltage range, high common mode rejection and low input bias current. These features result in optimum performance for small signal level and low frequency applications. Use of advanced design, processing and testing techniques make Linear's OP-07 a superior choice over similar products. A buffered reference application is shown below. For single op amp applications requiring higher performance, see the **LT1001** and for matched dual precision applications see the **LT1002**.

Precision Buffered Single Supply Reference

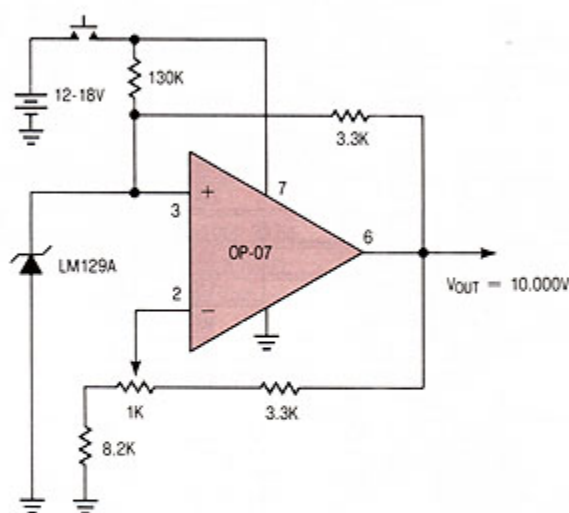

The OP-07 contributes less than 5% of the total drift with temperature, noise and long term drift of the reference application.

Offset Voltage Drift With Temperature
 Of Representative Units

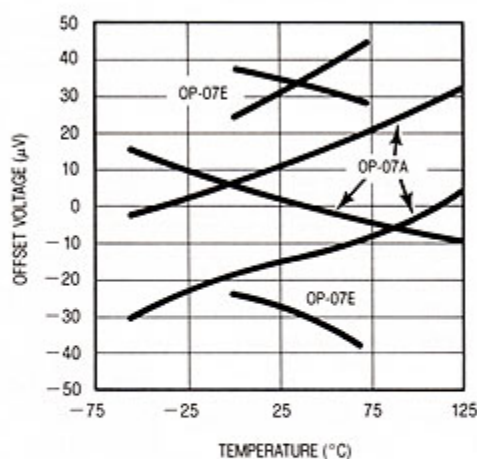

ABSOLUTE MAXIMUM RATINGS

Supply Voltage..... ±22V
 Differential Input Voltage..... ±30V
 Input Voltage Equal to Supply Voltage
 Output Short Circuit Duration..... Indefinite
 Operating Temperature Range
 OP-07/OP-07A..... -55°C to 125°C
 OP-07E/OP-07C..... 0°C to 70°C
 Storage Temperature Range
 All Devices..... -65°C to 150°C
 Lead Temperature (Soldering, 10 sec.)..... 300°C

PACKAGE/ORDER INFORMATION

TOP VIEW OFFSET ADJUST	ORDER PART NO.	OFFSET VOLTAGE (MAX)
<p>METAL CAN H PACKAGE</p>	OP-07AH OP-07H OP-07EH OP-07CH	25µV 75µV 75µV 150µV
TOP VIEW		
<p>HERMETIC DIP J8 PACKAGE PLASTIC DIP N8 PACKAGE</p>	OP-07AJ8 OP-07J8 OP-07EJ8 OP-07CJ8 OP-07EN8 OP-07CN8	25µV 75µV 75µV 150µV 75µV 150µV

ELECTRICAL CHARACTERISTICS $V_S = \pm 15V$, $T_A = 25^\circ C$, unless otherwise noted.

SYMBOL	PARAMETER	CONDITIONS	OP-07A			OP-07			UNITS
			MIN	TYP	MAX	MIN	TYP	MAX	
V_{OS}	Input Offset Voltage	(Note 1)		10	25		30	75	µV
$\frac{\Delta V_{OS}}{\Delta Time}$	Long Term Input Offset Voltage Stability	(Notes 2 and 3)		0.2	1.0		0.2	1.0	µV/Month
I_{OS}	Input Offset Current			0.3	2.0		0.4	2.8	nA
I_B	Input Bias Current			±0.7	±2.0		±1.0	±3.0	nA
e_n	Input Noise Voltage	0.1Hz to 10Hz (Note 2)		0.35	0.6		0.35	0.6	µV _{p-p}
	Input Noise Voltage Density	$f_o = 10Hz$ $f_o = 100Hz$ (Note 2) $f_o = 1000Hz$		10.3	18.0		10.3	18.0	nV/√Hz
				10.0	13.0		10.0	13.0	
				9.6	11.0		9.6	11.0	
i_n	Input Noise Current	0.1Hz to 10Hz (Note 2)		14	30		14	30	pA _{p-p}
	Input Noise Current Density	$f_o = 10Hz$ $f_o = 100Hz$ (Note 2) $f_o = 1000Hz$		0.32	0.80		0.32	0.80	pA/√Hz
				0.14	0.23		0.14	0.23	
				0.12	0.17		0.12	0.17	
R_{in}	Input Resistance Differential Mode	(Note 4)	30	80		20	60		MΩ
	Input Resistance Common Mode			200			200		GΩ
	Input Voltage Range		±13.5	±14.0		±13.5	±14.0		V
CMRR	Common Mode Rejection Ratio	$V_{CM} = \pm 13V$	110	126		110	126		dB
PSRR	Power Supply Rejection Ratio	$V_S = \pm 3V$ to $\pm 18V$	100	108		100	108		dB
A_{VOL}	Large Signal Voltage Gain	$R_L \geq 2k\Omega$, $V_O = \pm 10V$ $R_L \geq 500\Omega$, $V_O = \pm 0.5V$ $V_S = \pm 3V$ (Note 4)	300	500		200	500		V/mV
			150	400		150	400		
V_{OUT}	Maximum Output Voltage Swing	$R_L \geq 10k\Omega$ $R_L \geq 2k\Omega$ $R_L \geq 1k\Omega$	±12.5	±13.0		±12.5	±13.0		V
			±12.0	±12.8		±12.0	±12.8		
			±10.5	±12.0		±10.5	±12.0		
SR	Slew Rate	$R_L \geq 2k\Omega$ (Note 4)	0.1	0.25		0.1	0.25		V/µS
GBW	Closed Loop Bandwidth	$A_{VCL} = +1$ (Note 4)	0.4	0.6		0.4	0.6		MHz
Z_o	Open Loop Output Impedance	$V_O = 0$, $I_O = 0$, $f = 10Hz$		60			60		Ω
P_d	Power Dissipation	$V_S = \pm 15V$ $V_S = \pm 3V$		75	120		75	120	mW
				4	6		4	6	
	Offset Adjustment Range	Null Pot = 20kΩ		±4			±4		mV

See Notes on page 4.

ELECTRICAL CHARACTERISTICS $V_S = \pm 15V, -55^\circ C \leq T_A \leq 125^\circ C$, unless otherwise noted.

SYMBOL	PARAMETER	CONDITIONS	OP-07A			OP-07			UNITS
			MIN	TYP	MAX	MIN	TYP	MAX	
V_{OS}	Input Offset Voltage	(Note 1)	●	25	60	60	200	μV	
$\frac{\Delta V_{OS}}{\Delta Temp}$	Average Input Offset Voltage Drift Without External Trim With External Trim	Null Pot = 20k Ω (Note 2)	●	0.2 0.2	0.6 0.6	0.3 0.3	1.3 1.3	$\mu V/^\circ C$	
I_{OS}	Input Offset Current		●	0.8	4.0	1.2	5.6	nA	
$\frac{\Delta I_{OS}}{\Delta Temp}$	Average Input Offset Current Drift	(Note 2)	●	5	25	8	50	pA/°C	
I_B	Input Bias Current		●	± 1.0	± 4.0	± 2.0	± 6.0	nA	
$\frac{\Delta I_B}{\Delta Temp}$	Average Input Bias Current Drift	(Note 2)	●	8	25	13	50	pA/°C	
	Input Voltage Range		●	± 13.0	± 13.5	± 13.0	± 13.5	V	
CMRR	Common Mode Rejection Ratio	$V_{CM} = \pm 13V$	●	106	123	106	123	dB	
PSRR	Power Supply Rejection Ratio	$V_S = \pm 3V$ to $\pm 18V$	●	94	106	94	106	dB	
A_{VOL}	Large Signal Voltage Gain	$R_L \geq 2k\Omega, V_O = \pm 10V$	●	200	400	150	400	V/mV	
V_{OUT}	Output Voltage Swing	$R_L \geq 2k\Omega$	●	± 12.0	± 12.6	± 12.0	± 12.6	V	

ELECTRICAL CHARACTERISTICS $V_S = \pm 15V, T_A = 25^\circ C$, unless otherwise noted.

SYMBOL	PARAMETER	CONDITIONS	OP-07E			OP-07C			UNITS
			MIN	TYP	MAX	MIN	TYP	MAX	
V_{OS}	Input Offset Voltage	(Note 1)		30	75	60	150	μV	
$\frac{\Delta V_{OS}}{\Delta Time}$	Long Term Input Offset Voltage Stability	(Notes 2 and 3)		0.3	1.5	0.4	2.0	$\mu V/Month$	
I_{OS}	Input Offset Current			0.5	3.8	0.8	6.0	nA	
I_B	Input Bias Current			± 1.2	± 4.0	± 1.8	± 7.0	nA	
e_n	Input Noise Voltage	0.1Hz to 10Hz (Note 2)		0.35	0.6	0.35	0.65	μV_{P-P}	
	Input Noise Voltage Density	$f_o = 10Hz$ $f_o = 100Hz$ (Note 2) $f_o = 1000Hz$		10.3 10.0 9.6	18.0 13.0 11.0	10.5 10.2 9.8	20.0 13.5 11.5	nV/ \sqrt{Hz}	
I_n	Input Noise Current	0.1Hz to 10Hz (Note 2)		14	30	15	35	pA $_{P-P}$	
	Input Noise Current Density	$f_o = 10Hz$ $f_o = 100Hz$ (Note 2) $f_o = 1000Hz$		0.32 0.14 0.12	0.80 0.23 0.17	0.32 0.15 0.13	0.90 0.27 0.18	pA/ \sqrt{Hz}	
R_{in}	Input Resistance Differential Mode	(Note 4)		15	50	8	33	M Ω	
	Input Resistance Common Mode				160		120	G Ω	
	Input Voltage Range			± 13.5	± 14.0	± 13.0	± 14.0	V	
CMRR	Common Mode Rejection Ratio	$V_{CM} = \pm 13V$		106	123	100	120	dB	
PSRR	Power Supply Rejection Ratio	$V_S = \pm 3V$ to $\pm 18V$		94	106	90	104	dB	
A_{VOL}	Large Signal Voltage Gain	$R_L \geq 2k\Omega, V_O = \pm 10V$ $R_L \geq 500\Omega, V_O = \pm 0.5V$ $V_S = \pm 3V$ (Note 4)		200 150	500 400	120 100	400 400	V/mV	
V_O	Maximum Output Voltage Swing	$R_L \geq 10k\Omega$ $R_L \geq 2k\Omega$ $R_L \geq 1k\Omega$		± 12.5 ± 12.0 ± 10.5	± 13.0 ± 12.8 ± 12.0	± 12.5 ± 11.5 ± 12.0	± 13.0 ± 12.8 ± 12.0	V	
SR	Slewing Rate	$R_L \geq 2k\Omega$ (Note 2)		0.1	0.25	0.1	0.25	V/ μS	
GBW	Closed Loop Bandwidth	$A_{VCL} = +1$ (Note 2)		0.4	0.6	0.4	0.6	MHz	
Z_o	Open Loop Output Impedance	$V_O = 0, I_O = 0, f = 10Hz$			60		60	Ω	
P_d	Power Dissipation	$V_S = \pm 15V$ $V_S = \pm 3V$		75 4	120 6	80 4	150 8	mW mW	
	Offset Adjustment Range	Null Pot = 20k Ω		± 4		± 4		mV	

See Notes on page 4.

ELECTRICAL CHARACTERISTICS $V_S = \pm 15V$, $0^\circ C \leq T_A \leq 70^\circ C$, unless otherwise noted.

SYMBOL	PARAMETER	CONDITIONS	OP-07E			OP-07C			UNITS
			MIN	TYP	MAX	MIN	TYP	MAX	
V_{OS}	Input Offset Voltage		●	45	130	85	250	μV	
$\frac{\Delta V_{OS}}{\Delta Temp}$	Average Input Offset Voltage Drift Without External Trim With External Trim	Null Pot = 20k Ω (Note 2)	●	0.3 0.3	1.3 1.3	0.5 0.4	1.8 1.6	$\mu V/^\circ C$	
I_{OS}	Input Offset Current		●	0.9	5.3	1.6	8.0	nA	
$\frac{\Delta I_{OS}}{\Delta Temp}$	Average Input Offset Current Drift	(Note 2)	●	8	35	12	50	pA/ $^\circ C$	
I_B	Input Bias Current		●	± 1.5	± 5.5	± 2.2	± 9.0	nA	
$\frac{\Delta I_B}{\Delta Temp}$	Average Input Bias Current Drift	(Note 2)	●	13	35	18	50	pA/ $^\circ C$	
	Input Voltage Range		●	± 13.0	± 13.5	± 13.0	± 13.5	V	
CMRR	Common Mode Rejection Ratio	$V_{CM} = \pm 13V$	●	103	123	97	120	dB	
PSRR	Power Supply Rejection Ratio	$V_S = \pm 3V$ to $\pm 18V$	●	90	104	86	100	dB	
A_{VOL}	Large Signal Voltage Gain	$R_L \geq 2k\Omega$, $V_O = \pm 10V$	●	180	450	100	400	V/mV	
V_{OUT}	Output Voltage Swing	$R_L \geq 2k\Omega$	●	± 12.0	± 12.6	± 11.0	± 12.6	V	

The ● denotes the specifications which apply over full operating temperature range.

For MIL-STD components, please refer to LTC 883C data sheet for test listing and parameters.

Note 1: Offset voltage for the OP-07A is measured 60 seconds after power is applied. All other grades are measured with high speed test equipment, approximately 1 second after power is applied.

Note 2: This parameter is tested on a sample basis only.

Note 3: Long term Input Offset Voltage Stability refers to the averaged trend line of V_{OS} versus Time over extended periods after the first 30 days of operation. Excluding the initial hour of operation, changes in V_{OS} during the first 30 operating days are typically $2.5\mu V$.

Note 4: This parameter is guaranteed by design.

Note 5: The OP-07D is available by special request.

TYPICAL PERFORMANCE CHARACTERISTICS

**Low Frequency Noise
(Closed Loop Gain = 25,000)**

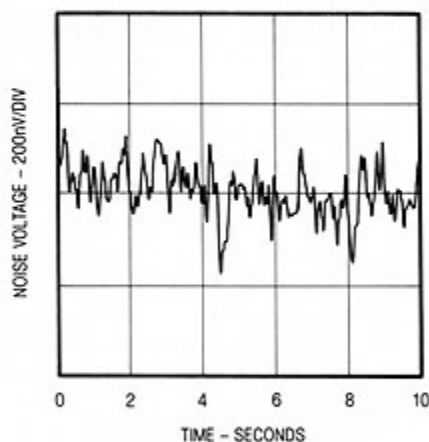

**Total Input Noise Voltage
vs Frequency**

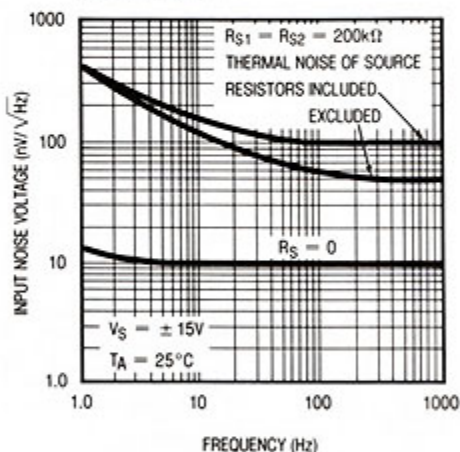

**Open-Loop
Frequency Response**

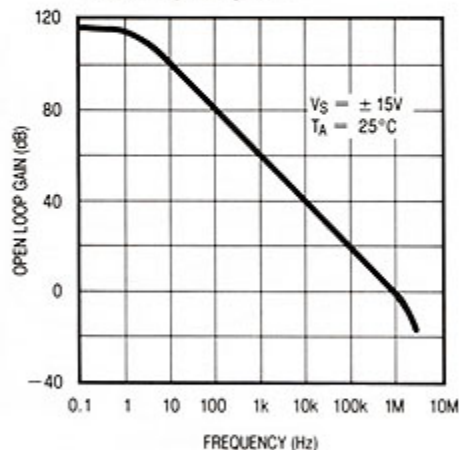

**Common Mode Rejection Ratio
vs Frequency**

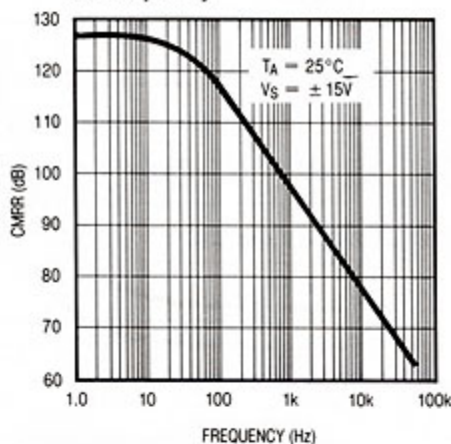

**Power Supply Rejection Ratio
vs Frequency**

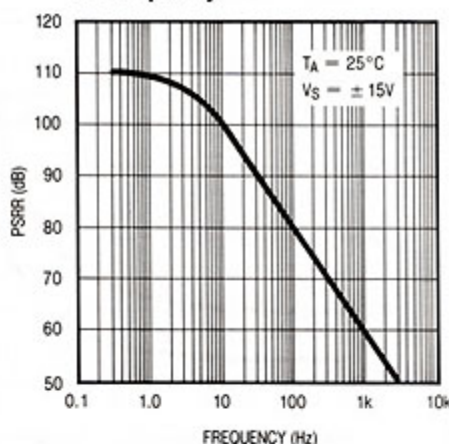

**Long Term Stability of Four
Representative Units**

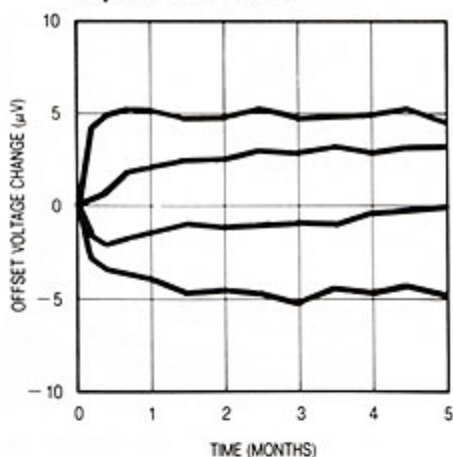

Warm-Up Drift

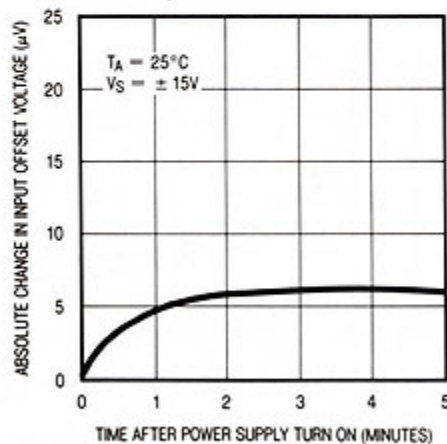

**Offset Voltage Change Due
to Thermal Shock**

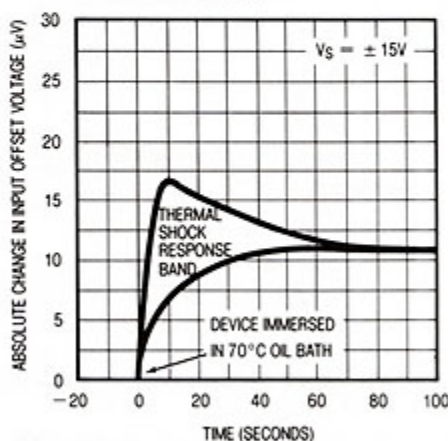

**Open-Loop Gain vs
Temperature**

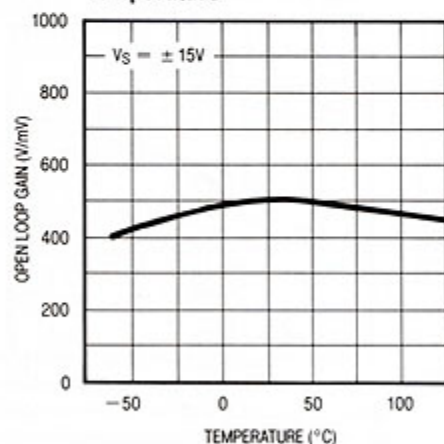

TYPICAL PERFORMANCE CHARACTERISTICS

Input Bias Current vs Temperature

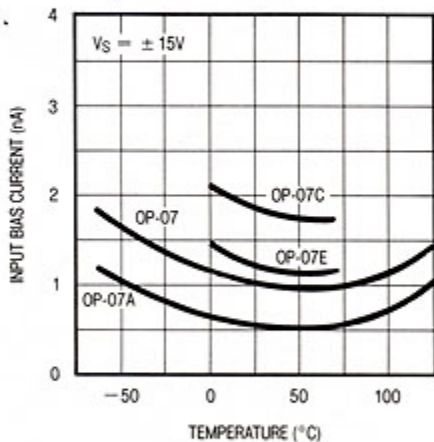

Input Offset Current vs Temperature

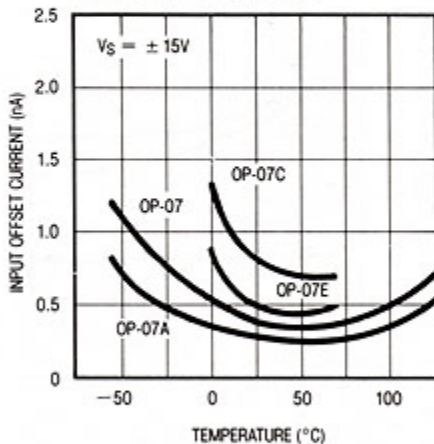

Input Bias Current vs Differential Input Voltage

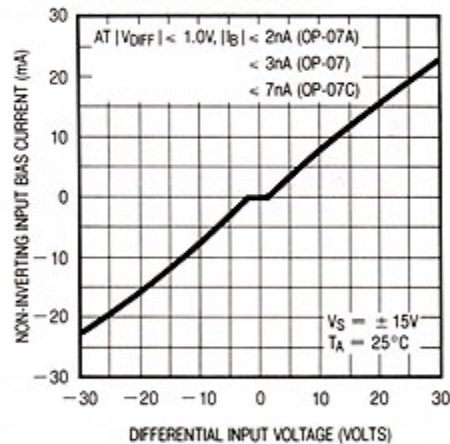

Maximum Error vs Source Resistance

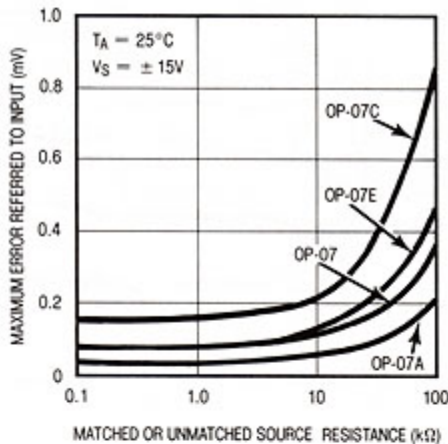

Maximum Error vs Source Resistance

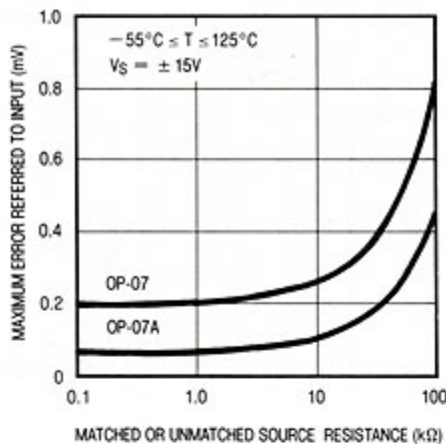

Maximum Error vs Source Resistance

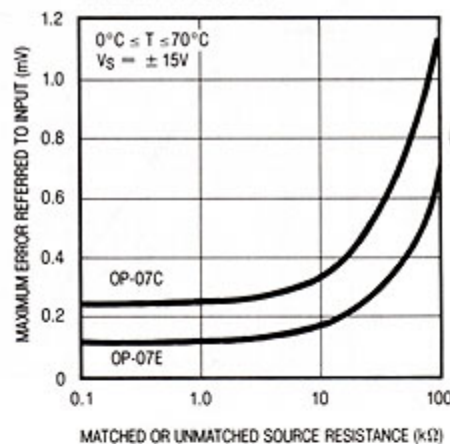

Output Voltage vs Load Resistance

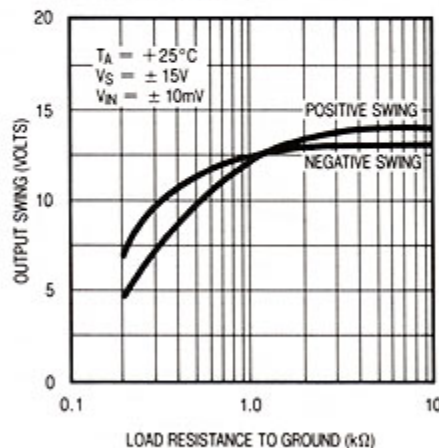

Power Consumption vs Power Supply

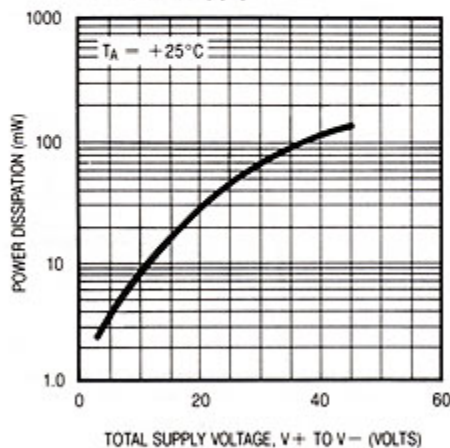

Output Short-Circuit Current vs Time

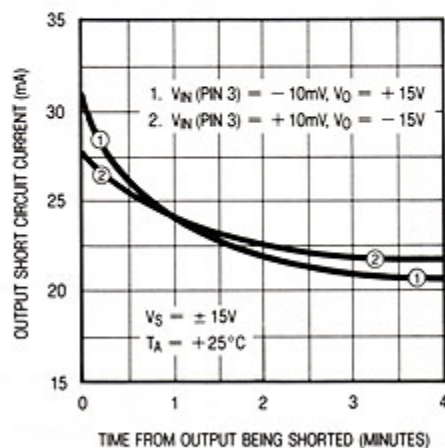

TYPICAL APPLICATIONS

Precision Summing Amplifier

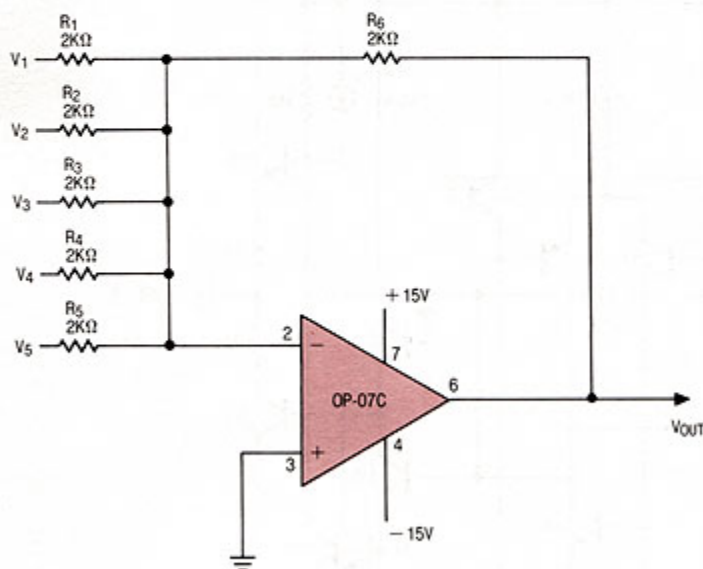

Instrumentation Amplifier

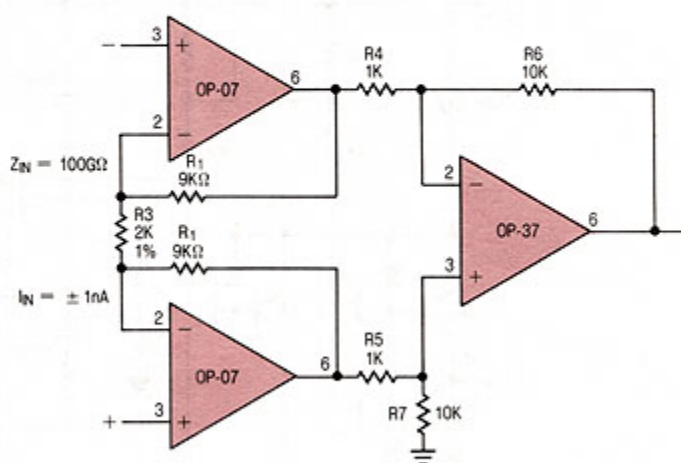

$$A_V = \frac{R_6}{R_4} \left(\frac{2R_1}{R_3} + 1 \right)$$

$$A_V = 100$$

TEST CIRCUIT DIAGRAMS

Offset Voltage Test Circuit †

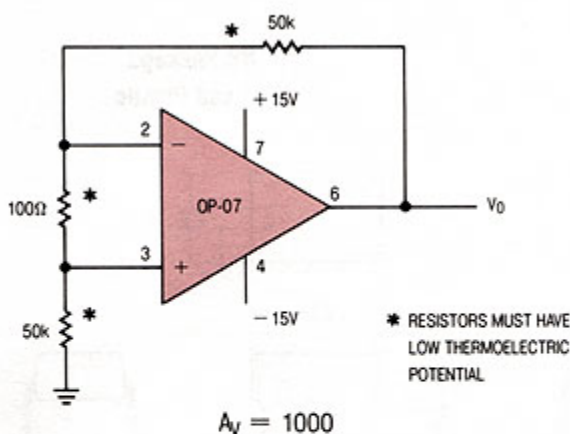

$$A_V = 1000$$

Offset Nulling and Low Frequency Noise Test Circuit

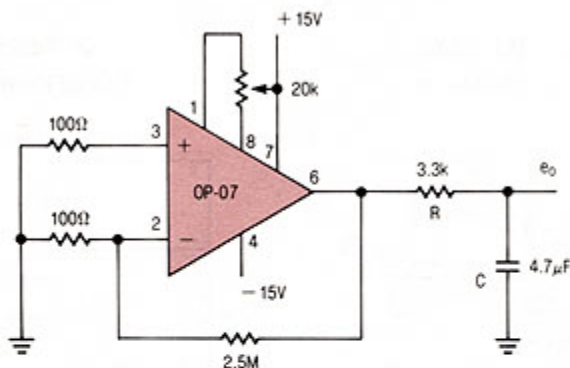

NOTES:

- 1) RC APPROXIMATELY 10Hz FILTER
- 2) OBSERVE OUTPUT FOR 10 SECONDS
 $A_V = 25000$

Application Tip:

When the OP-07 is used as a replacement in 725, 108/108A, 308/308A applications, removal of external compensation is optional. For conventionally nulled 741 type applications, external trimming should be removed. Care should be taken to avoid thermocouple voltages caused by temperature variations between the input terminals or dissimilar metals.

SCHEMATIC DIAGRAM

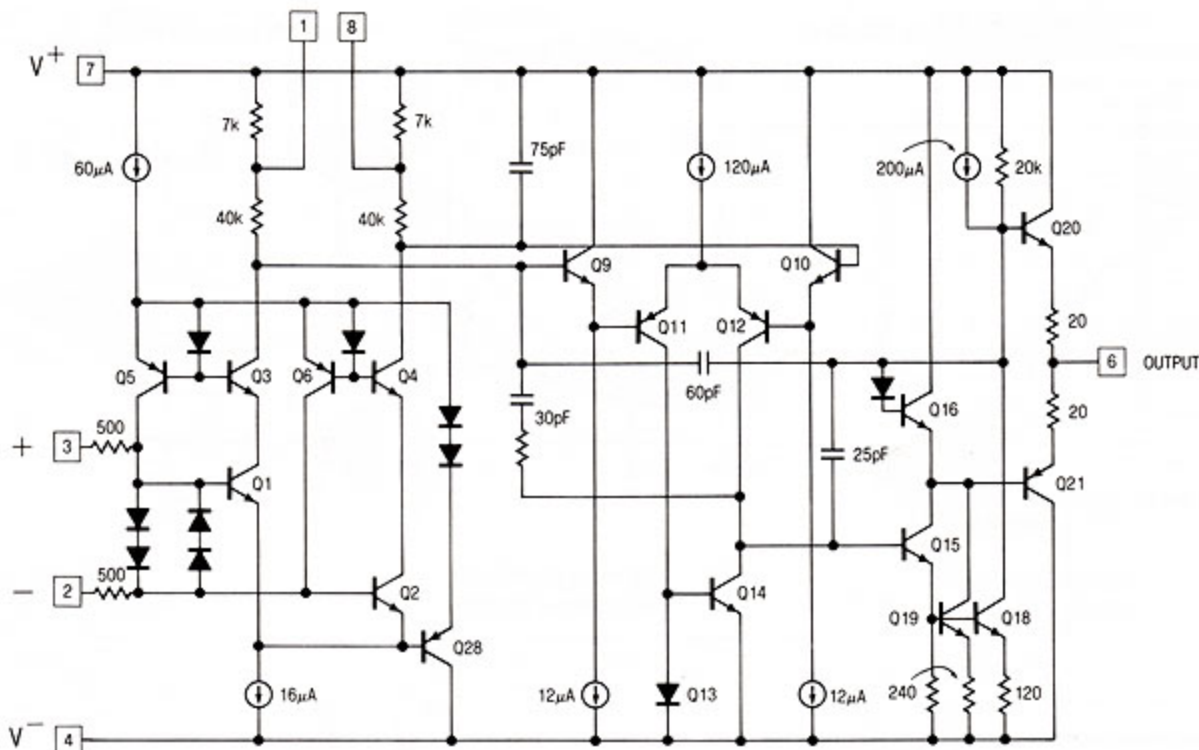

PACKAGE DESCRIPTION

H Package
Metal Can

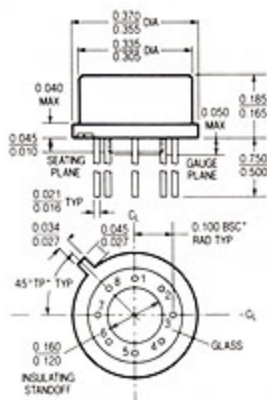

NOTE: DIMENSIONS IN INCHES

T_{jmax}	θ_{ja}	θ_{jc}
150°C	150°C/W	45°C/W

J8 Package
8 Lead Hermetic Dip

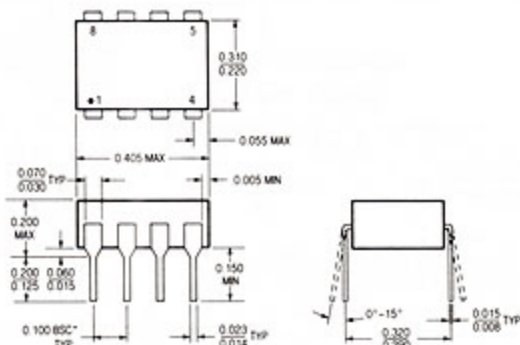

NOTE: DIMENSIONS IN INCHES UNLESS OTHERWISE NOTED
*LEADS WITHIN 0.007 OF TRUE POSITION (TYP) AT GAUGE PLANE

T_{jmax}	θ_{ja}
150°C	100°C/W

N8 Package
8 Lead Plastic

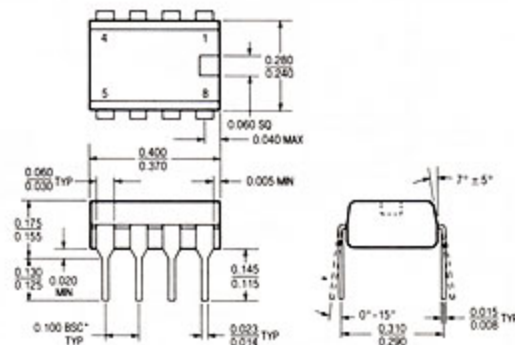

NOTE: DIMENSIONS IN INCHES UNLESS OTHERWISE NOTED
*LEADS WITHIN 0.007 OF TRUE POSITION (TYP) AT GAUGE PLANE

T_{jmax}	θ_{ja}
100°C	130°C/W