

NPN Silicon Phototransistors

Types OP508FA, OP508FB, OP508FC

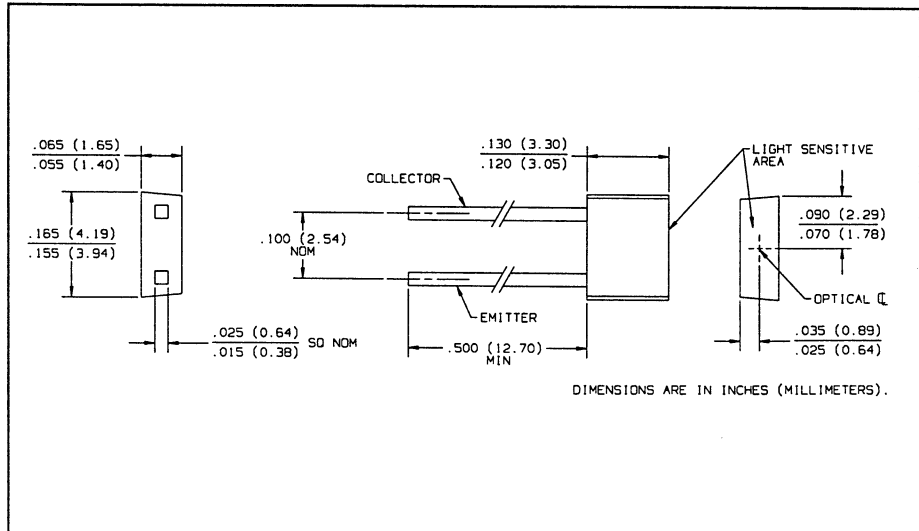
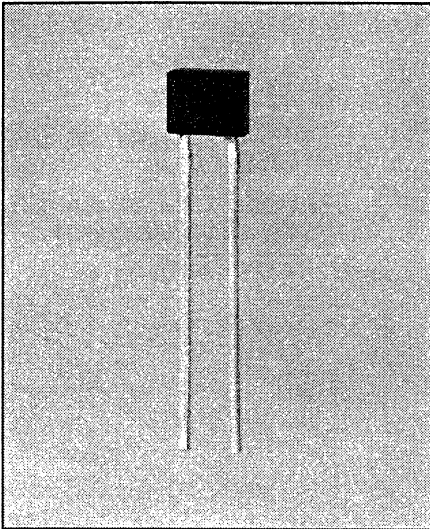

Features

- Flat lensed for wide acceptance angle
- Easily stackable on 0.100 inch (2.54 mm) hole centers
- Low cost plastic package
- Mechanically and spectrally matched to the OP168F and OP268F series of infrared emitting diodes

Description

The OP508F series consist of NPN silicon phototransistors mounted in flat, black plastic, "end looking" packages. The flat sensing surface allows an acceptance half angle of 60° measured from the optical axis to the half power point. The black plastic package significantly reduces ambient light noise. These devices can be mounted on 0.100" (2.54 mm) hole centers, making them an ideal low cost alternate to hermetic OP600 sensors.

Absolute Maximum Ratings (T_A = 25° C unless otherwise noted)

| | |
|--|-----------------------|
| Collector-Emitter Voltage | 30 V |
| Emitter-Collector Voltage | 5.0 V |
| Storage and Operating Temperature Range | -40° C to +100° C |
| Lead Soldering Temperature [1/16 inch (1.6 mm) from case for 5 sec. with soldering iron] | 260° C ⁽¹⁾ |
| Power Dissipation | 100 mW ⁽²⁾ |

Notes:

- (1) RMA flux is recommended. Duration can be extended to 10 seconds max. when flow soldering. Maximum 20 grams force may be applied to the leads when soldering.
- (2) Derate linearly 1.33 mW/° C above 25° C.
- (3) Light source is an unfiltered GaAs LED with a peak emission wavelength of 935 nm and a radiometric intensity level which varies less than 10% over the entire lens surface of the phototransistor being tested.
- (4) To calculate typical collector dark current in μA , use the formula $I_{CE0} = 10^{(0.040T_A - 3.4)}$ where T_A is ambient temperature in ° C.

Typical Performance Curves

Typical Spectral Response

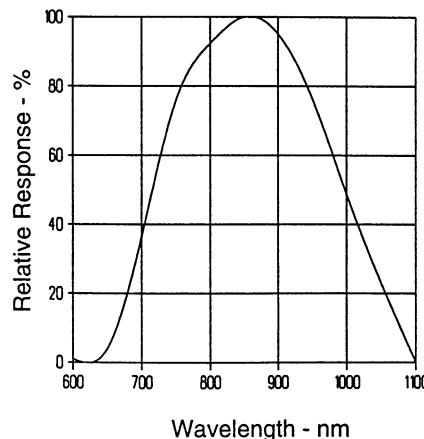

Coupling Characteristics of OP168F and OP508F

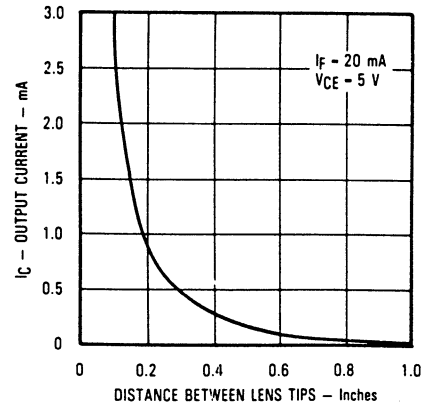

Types OP508FA, OP508FB, OP508FC

Electrical Characteristics ($T_A = 25^\circ\text{C}$ unless otherwise noted)

| SYMBOL | PARAMETER | MIN | TYP | MAX | UNITS | TEST CONDITIONS |
|----------------|--|---|------|------|---------------------|--|
| $I_{C(ON)}$ | On-State Collector Current | OP508FC 0.34 OP508FB 0.65 OP508FA 2.70 | | 5.10 | mA | $V_{CE} = 5.0\text{ V}$, $E_e = 5\text{ mW/cm}^2(3)$ |
| $I_C/\Delta T$ | Relative I_C Change with Temperature | | 1.00 | | %/ $^\circ\text{C}$ | $V_{CE} = 5.0\text{ V}$, $E_e = 1.0\text{ mW/cm}^2(3)$, $\lambda = 890\text{ nm}$ |
| I_{CEO} | Collector-Dark Current | | | 100 | nA | $V_{CE} = 10.0\text{ V}$, $E_e = 0(4)$ |
| $V_{(BR)CEO}$ | Collector-Emitter Breakdown Voltage | 30 | | | V | $I_C = 100\ \mu\text{A}$ |
| $V_{(BR)ECO}$ | Emitter-Collector Breakdown Voltage | 5.0 | | | V | $I_E = 100\ \mu\text{A}$ |
| $V_{CE(SAT)}$ | Collector-Emitter Saturation Voltage | | | 0.40 | V | $I_C = 100\ \mu\text{A}$, $E_e = 5\text{ mW/cm}^2(3)$ |

PHOTOSENSORS

Typical Performance Curves

Normalized Collector Current vs. Angular Displacement

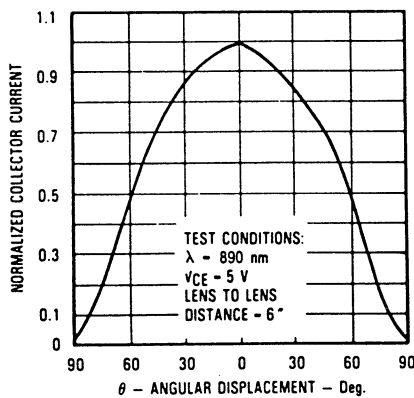

On-State Collector Current vs. Irradiance

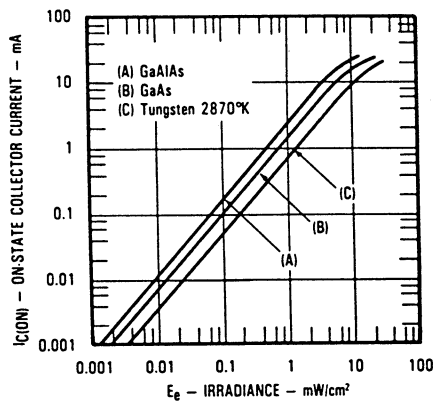

Normalized Collector Current vs. Collector to Emitter Voltage

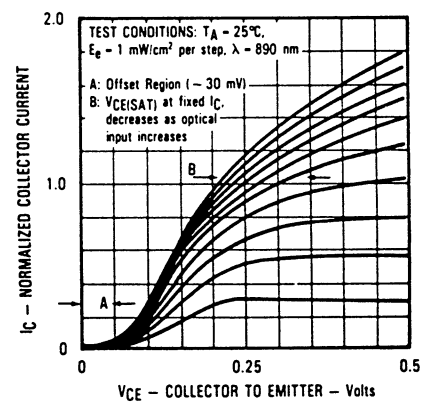

Rise and Fall Time vs. Load Resistance

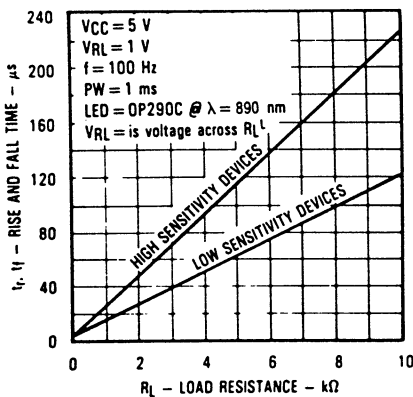

Normalized Output vs. Frequency

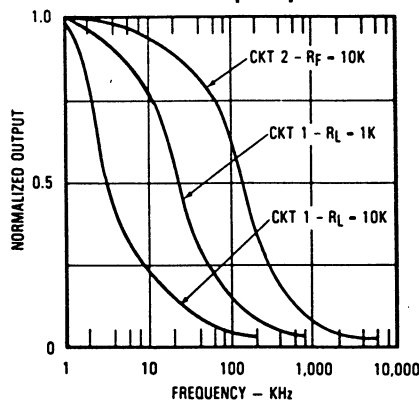

Switching Time Test Circuit

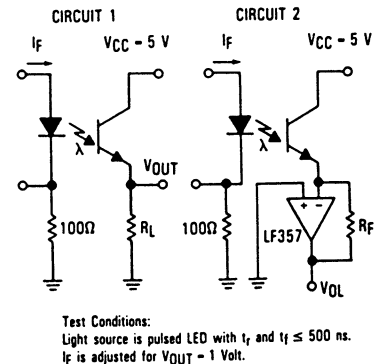

Optek reserves the right to make changes at any time in order to improve design and to supply the best product possible.

Optek Technology, Inc. 1215 W. Crosby Road Carrollton, Texas 75006 (972)323-2200 Fax (972)323-2396