

Fiber Optic Transmitter

OPF395 Series



OPF395 Series

- Low Cost 850 nm LED technology
- Electrically isolated plastic cap package
- High thermal stability
- High optical coupling efficiency to multimode fiber
- Industrial temperature range
- 75 MHz Bandwidth

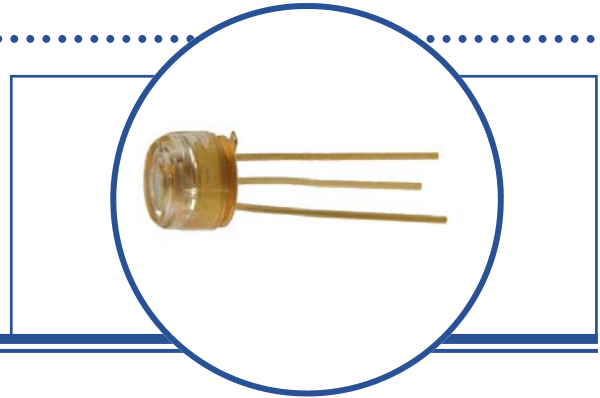

The OPF395 series fiber optic transmitters are high performance devices packaged for data communication links. This transmitter is an 850 nm GaAlAs LED and is specifically designed to efficiently launch optical power into fibers ranging in size from 50/125 μ m up to 200/300 μ m diameter fiber. Multiple power ranges with upper and lower limits are offered which allows the designer to select a device best suited for the application.

This product's combination of features including high speed and efficient coupled power makes it an ideal transmitter for integration into all types of data communications equipment.

Applications

- ◆ Industrial Ethernet equipment
- ◆ Copper-to-fiber media conversion
- ◆ Intra-system fiber optic links
- ◆ Video surveillance systems

Typical Coupled Power $I_F = 100\text{mA}, 25^\circ\text{C}$						
Fiber Size	Type	N.A.	OPF395A	OPF395B	OPF395C	OPF395D
50/125 μ m	Graded Index	0.20	25 μ W	18 μ W	12.5 μ W	7.5 μ W
62.5/125 μ m	Graded Index	0.28	75 μ W	45 μ W	35 μ W	27 μ W
100/140 μ m	Graded Index	0.29	170 μ W	115 μ W	85 μ W	58 μ W
200/300 μ m	Step Index	0.41	650 μ W	545 μ W	450 μ W	290 μ W



RoHS

OPTEK reserves the right to make changes at any time in order to improve design and to supply the best product possible.

Absolute Maximum Ratings

$T_A = 25^\circ\text{C}$ unless otherwise noted

Storage Temperature Range	-55° C to +150° C
Operating Temperature Range	-40° C to +125° C
Lead Soldering Temperature ⁽¹⁾	260° C
Continuous Forward Current ⁽²⁾	100 mA
Maximum Reverse Voltage	1.0 V

Electrical/Optical Characteristics ($T_A = 25^\circ\text{C}$ unless otherwise noted)

SYMBOL	PARAMETER	DOT	MIN	TYP	MAX	UNITS	CONDITIONS
$P_{T50}^{(3)}$	Total Coupled Power 50/125 mm Fiber NA = 0.20	OPF395A Orange	20.0	25.0		μW	$I_F = 100\text{ mA}$
		OPF395B Green	15.0	18.0			
		OPF395C Black	10.0	12.5			
		OPF395D Silver	5.0	7.5			
V_F	Forward Voltage			1.8	2.2	V	$I_F = 100\text{ mA}$
V_R	Reverse Voltage		1.8			V	$I_R = 100\ \mu\text{A}$
λ	Wavelength		830	850	870	nm	$I_F = 50\text{ mA}$
$\Delta\lambda$	Optical Bandwidth			35		nm	$I_F = 50\text{ mA}$
t_r, t_f	Rise and Fall Time			3.5	4.5	ns	$I_F = 100\text{ mA}; 10\% \text{ to } 90\%^{(4)}$

Notes:

- Maximum of 5 seconds with soldering iron. Duration can be extended to 10 seconds when flow soldering. RMA flux is recommended.
- De-rate linearly at 1.0mA /°C above 25°C .
- The component must be actively aligned into the mating fiber cable assembly to achieve optimal performance.
- No Pre-bias.
- All Optek fiber optic LED products are subjected to 100% burn-in as part of its quality control process. The burn-in conditions are 96 hours at 100mA drive current and 25°C ambient temperature.

Relative Coupled Power vs. Forward Current

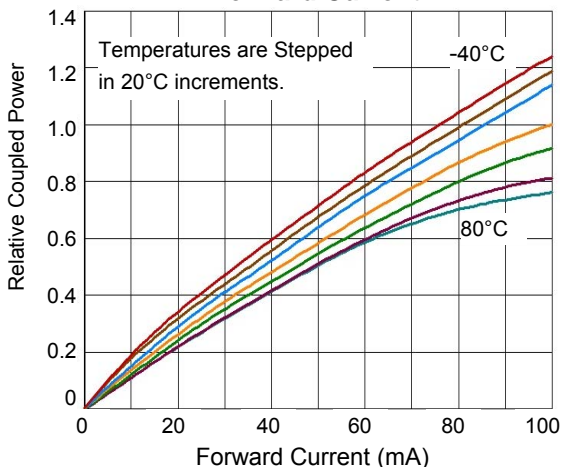

Typical Forward Voltage vs. Forward Current

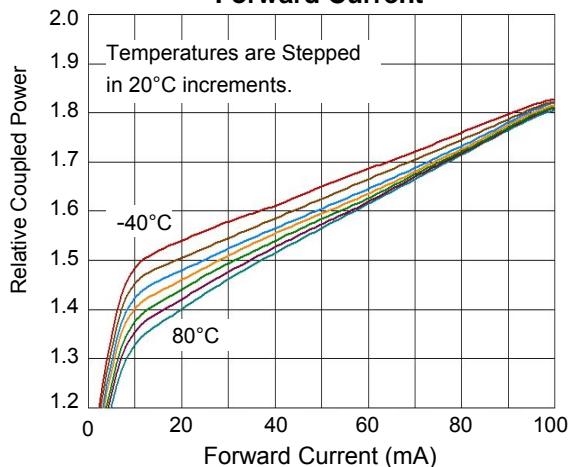

OPTEK reserves the right to make changes at any time in order to improve design and to supply the best product possible.

Mechanical Data

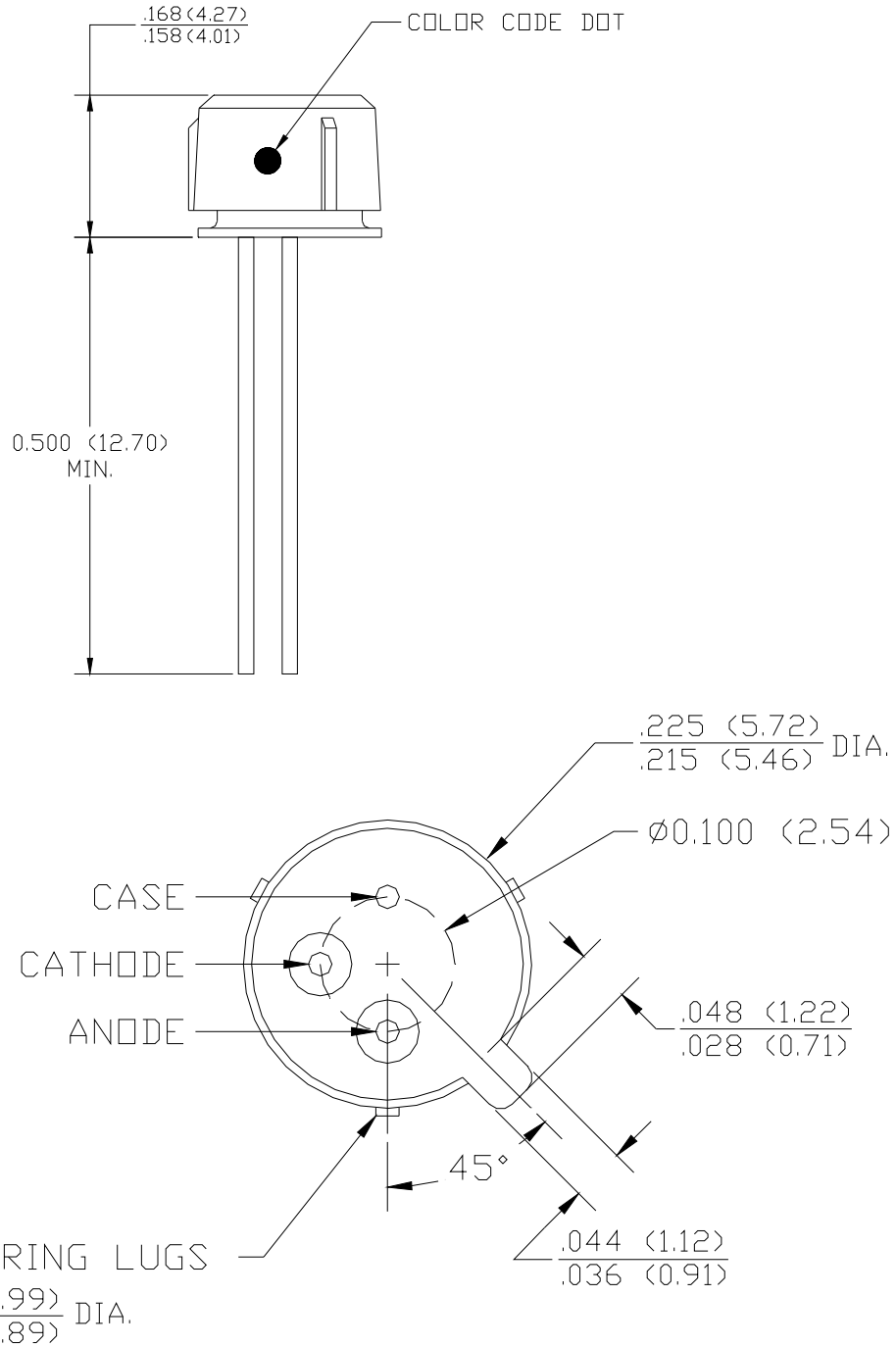

DIMENSIONS ARE IN INCHES (MILLIMETERS)

OPTEK reserves the right to make changes at any time in order to improve design and to supply the best product possible.