

# PQ05RF1 Series

1A Output Low Power-Loss Voltage Regulators

## Features

- Compact resin full-mold package
- Low power-loss (Dropout voltage: MAX.0.5V)
- Built-in ON/OFF control terminal (PQ05RF1/PQ05RF11 series)
- Built-in output voltage minute adjustment terminal (Critical rate of ripple rejection is improved.) (PQ05RF1V series)
- Lead forming type (PQ05RF1A/1B series) is also available.

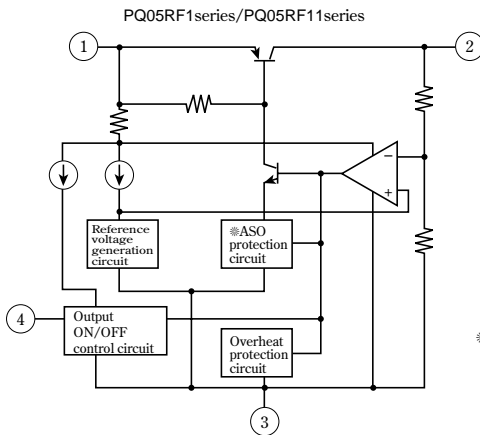
## Model Line-ups

Output voltage	5Voutput	9Voutput	12Voutput
Output voltage precision:±5%	PQ05RF1	PQ09RF1	PQ12RF1
Output voltage precision:±2.5%	PQ05RF11	PQ09RF11	PQ12RF11
Minute adjustment (Output voltage adjustment range:±10%)	PQ05RF1V	PQ09RF1V	PQ12RF1V

## Applications

- Seris power supply for various electronic equipment such as VCRs and musical instruments

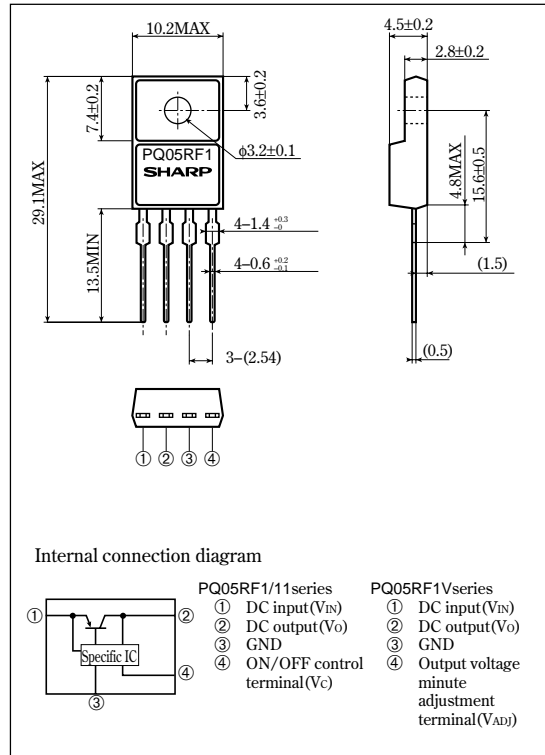
## Equivalent Circuit Diagram



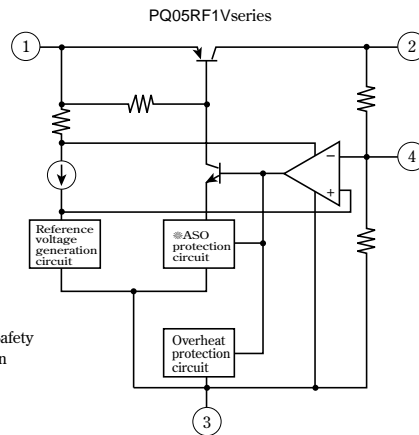
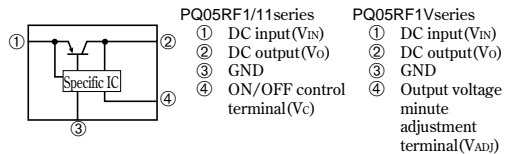
※ASO : Area of Safety Operation

## Outline Dimensions

(Unit : mm)



Internal connection diagram



•Please refer to the chapter " Handling Precautions ".

**Absolute Maximum Ratings**

(T<sub>a</sub>=25°C)

Parameter		Symbol	Rating	Unit
*1	Input voltage	V <sub>IN</sub>	35	V
*1	ON/OFF control terminal voltage	PQ05RF1 series	35	V
		PQ05RF11 series		
	Output current	I <sub>O</sub>	1	A
	Power dissipation(No heat sink)	P <sub>D1</sub>	1.5	W
	Power dissipation(With infinite heat sink)	P <sub>D2</sub>	15	W
*2	Junction temperature	T <sub>j</sub>	150	°C
	Operating temperature	T <sub>opr</sub>	-20 to +80	°C
	Storage temperature	T <sub>stg</sub>	-40 to +150	°C
	Soldering temperature	T <sub>sol</sub>	260 (For 10s)	°C

\*1 All are open except GND and applicable terminals.

\*2 Overheat protection may operate at 125<=T<sub>j</sub><=150°C

**Electrical Characteristics**

(Unless otherwise specified, condition shall be I<sub>O</sub>=0.5A, T<sub>a</sub>=25°C, \*3)

Parameter		Symbol	Conditions	MIN.	TYP.	MAX.	Unit
Output voltage	PQ05RF1/PQ05RF1V	V <sub>O</sub>	-	4.75	5.0	5.25	V
	PQ09RF1/PQ09RF1V			8.55	9.0	9.45	
	PQ12RF1/PQ12RF1V			11.4	12.0	12.6	
	PQ05RF11			4.88	5.0	5.12	
	PQ09RF11			8.78	9.0	9.22	
	PQ12RF11			11.7	12.0	12.3	
Load regulation		R <sub>egL</sub>	I <sub>O</sub> =5mA to 1A	-	0.1	2.0	%
Line regulation		R <sub>egI</sub>	*4, I <sub>O</sub> =5mA	-	0.5	2.5	%
Temperature coefficient of output voltage		T <sub>c</sub> V <sub>O</sub>	T <sub>j</sub> =0 to 125°C, I <sub>O</sub> =5mA	-	±0.02	-	%/°C
Ripple rejection	PQ05RF1/PQ05RF11 series	RR	Refer to Fig. 2.	45	55	-	dB
	PQ05RF1V series			55	-	-	
Dropout voltage		V <sub>FO</sub>	*5	-	-	0.5	V
ON-state voltage for control	PQ05RF1/PQ05RF11 series	V <sub>C(ON)</sub>	-	2.0 *6	-	-	V
ON-state current for control	PQ05RF1/PQ05RF11 series	I <sub>C(ON)</sub>	V <sub>C</sub> =2.7V	-	-	20	μA
OFF-state voltage for control	PQ05RF1/PQ05RF11 series	V <sub>C(OFF)</sub>	-	-	-	0.8	V
OFF-state current for control	PQ05RF1/PQ05RF11 series	I <sub>C(OFF)</sub>	V <sub>C</sub> =0.4V	-	-	-0.4	mA
Quiescent current		I <sub>q</sub>	I <sub>O</sub> =0	-	-	10	mA
Output voltage minute adjustment characteristics	PQ05RF1V	V <sub>O(ADJ)</sub>	-	4.5	5.0	5.5	V
	PQ09RF1V			8.1	9.0	9.9	
	PQ12RF1V			10.8	12.0	13.2	

\*3 PQ05RF1 series:V<sub>IN</sub>=7V, PQ09RF1 series:V<sub>IN</sub>=15V, PQ12RF1 series:V<sub>IN</sub>=18V

\*4 PQ05RF1/PQ05RF11/PQ05RF1V:V<sub>IN</sub>=6 to 12V

PQ09RF1/PQ09RF11/PQ09RF1V:V<sub>IN</sub>=10 to 25V

PQ12RF1/PQ12RF11/PQ12RF1V:V<sub>IN</sub>=13 to 29V

\*5 Input voltage shall be the value when output voltage is 95% in comparison with the initial value.

\*6 In case of opening control terminal ④, output voltage turns on. (PQ05RF1/PQ05RF11 series)

Fig.1 Test Circuit

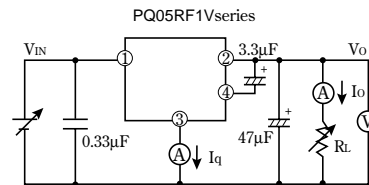
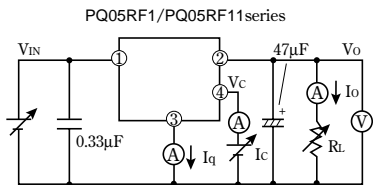


Fig.2 Test Circuit of Ripple Rejection

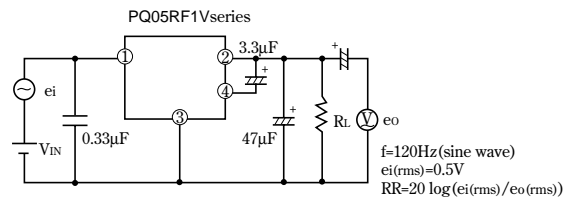
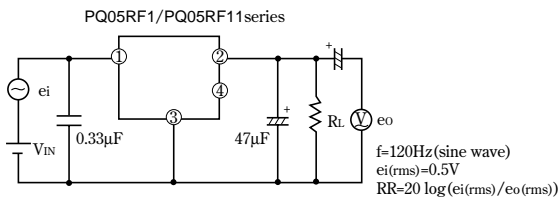
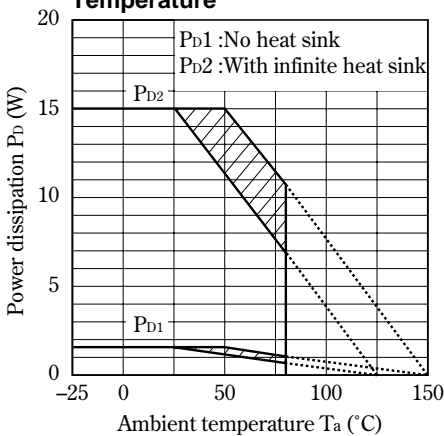


Fig.3 Power Dissipation vs. Ambient Temperature



Note) Oblique line portion : Overheat protection may operate in this area.

Fig.4 Overcurrent Protection Characteristics (Typical Value)

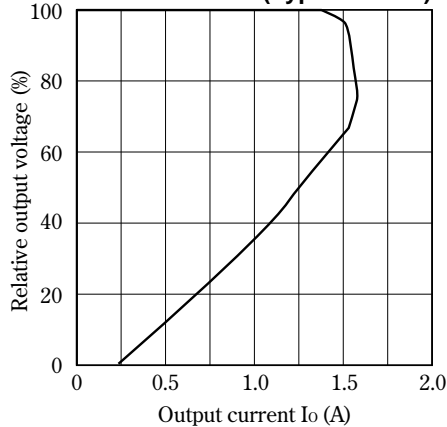


Fig.5 Output Voltage Minute Adjustment Characteristics (PQ05RF1V)

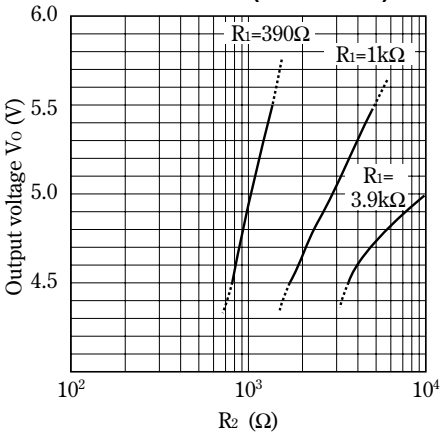
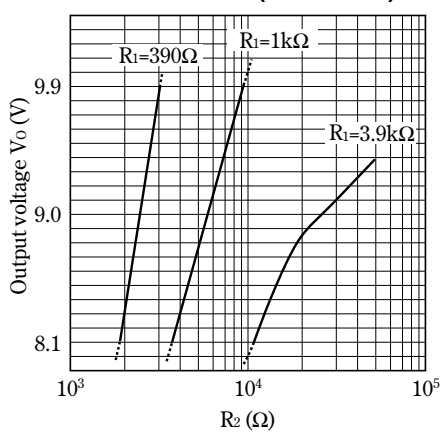
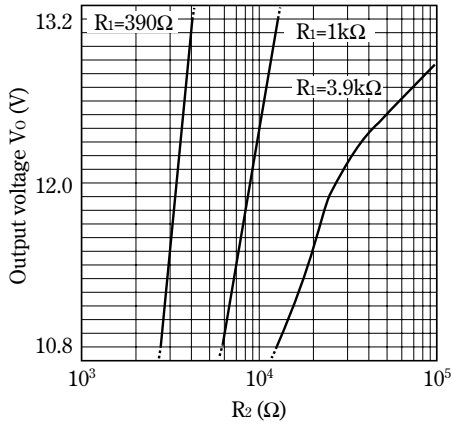


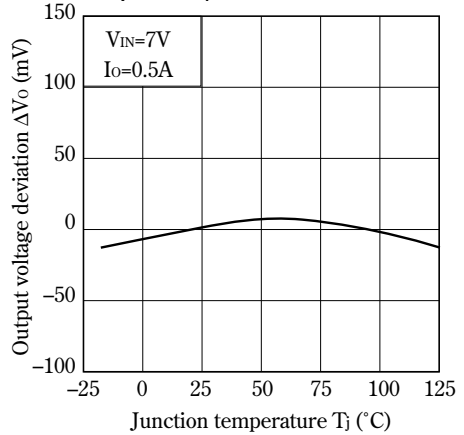
Fig.6 Output Voltage Minute Adjustment Characteristics (PQ09RF1V)



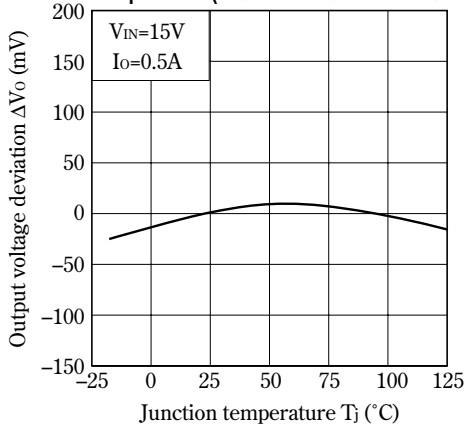
**Fig.7 Output Voltage Minute Adjustment Characteristics (PQ12RF1V)**



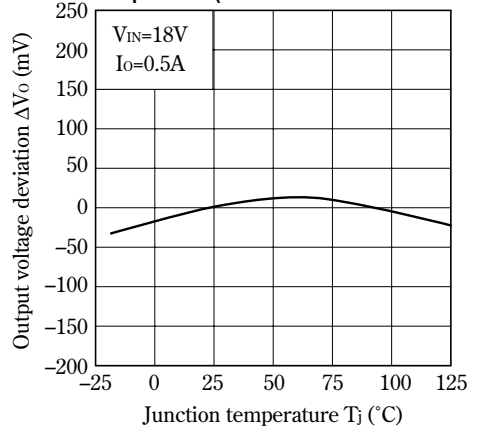
**Fig.8 Output Voltage Deviation vs. Junction Temperature (PQ05RF1/PQ05RF11/PQ05RF1V)**



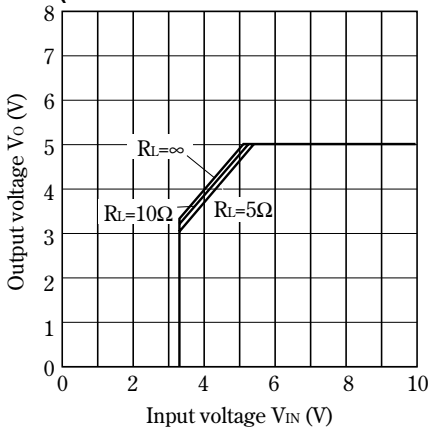
**Fig.9 Output Voltage Deviation vs. Junction Temperature (PQ09RF1/PQ09RF11/PQ09RF1V)**



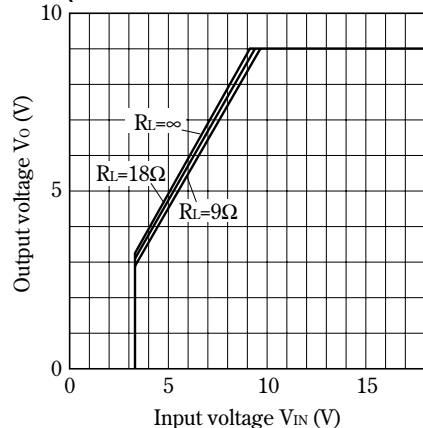
**Fig.10 Output Voltage Deviation vs. Junction Temperature (PQ12RF1/PQ12RF11/PQ12RF1V)**



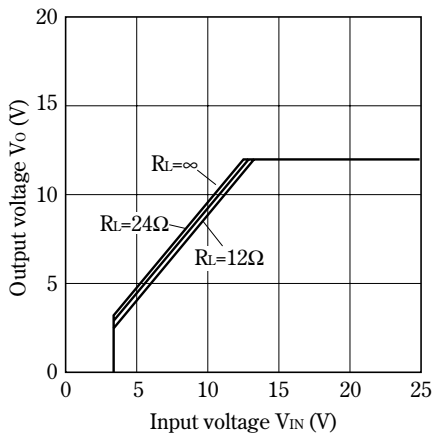
**Fig.11 Output Voltage vs. Input Voltage (PQ05RF1/PQ05RF11/PQ05RF1V)**



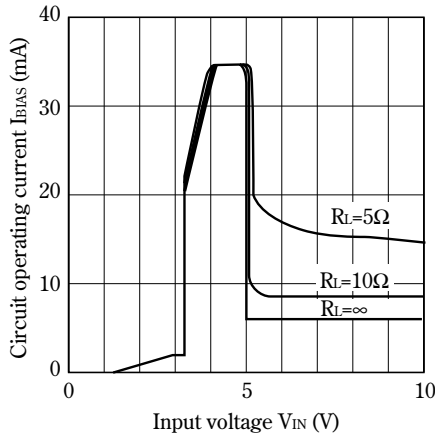
**Fig.12 Output Voltage vs. Input Voltage (PQ09RF1/PQ09RF11/PQ09RF1V)**



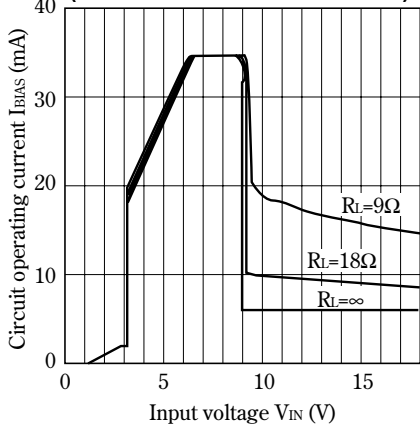
**Fig.13 Output Voltage vs. Input Voltage (PQ12RF1/PQ12RF11/PQ12RF1V)**



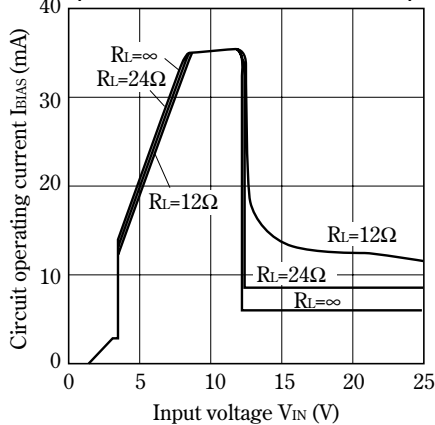
**Fig.14 Circuit Operating Current vs. Input Voltage (PQ05RF1/PQ05RF11/PQ05RF1V)**



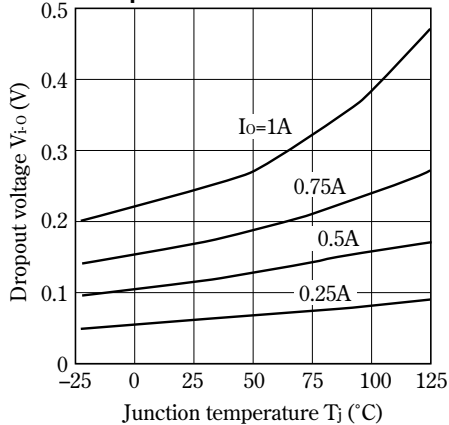
**Fig.15 Circuit Operating Current vs. Input Voltage (PQ09RF1/PQ09RF11/PQ09RF1V)**



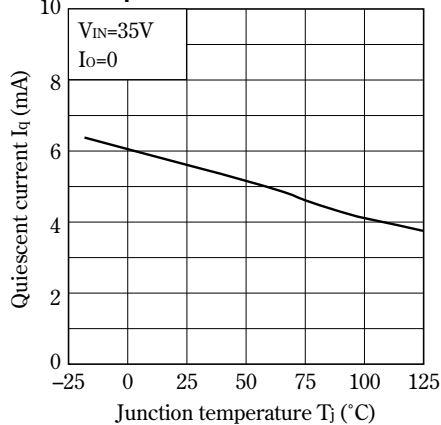
**Fig.16 Circuit Operating Current vs. Input Voltage (PQ12RF1/PQ12RF11/PQ12RF1V)**



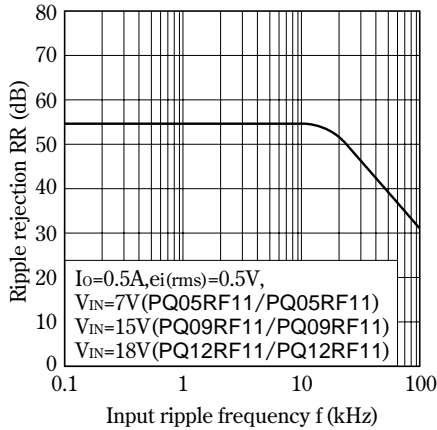
**Fig.17 Dropout Voltage vs. Junction Temperature**



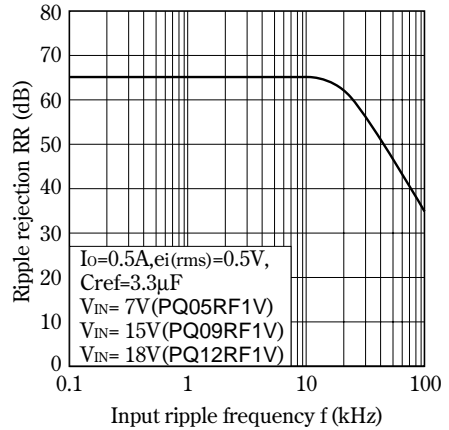
**Fig.18 Quiescent Current vs. Junction Temperature**



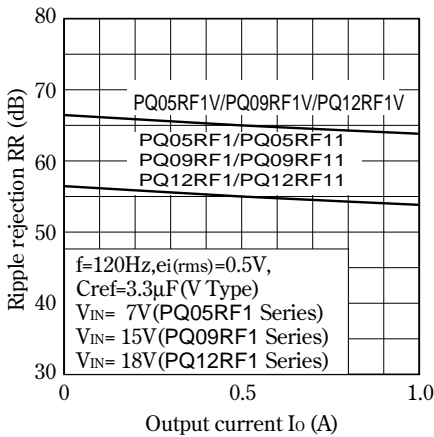
**Fig.19 Ripple Rejection vs. Input Ripple Frequency**  
(PQ05RF1/PQ05RF11/PQ09RF1/PQ09RF11/PQ12RF1/PQ12RF11)



**Fig.20 Ripple Rejection vs. Input Ripple Frequency**  
(PQ05RF1V/PQ09RF1V/PQ12RF1V)

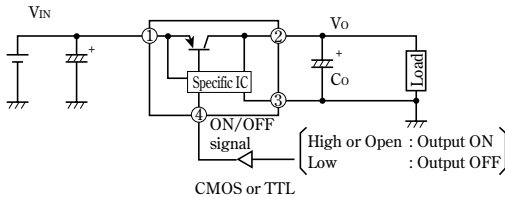


**Fig.21 Ripple Rejection vs. Output Current**

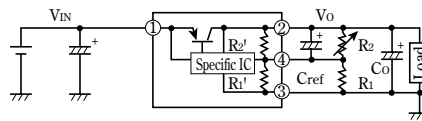


■ Typical Application

PQ05RF1/PQ05RF11 Series



PQ05RF1V Series



$$V_o = V_{ref} \times \left( 1 + \frac{R_2' \times R_2}{R_2' + R_2} \cdot \frac{R_1' + R_1}{R_1' \times R_1} \right)$$

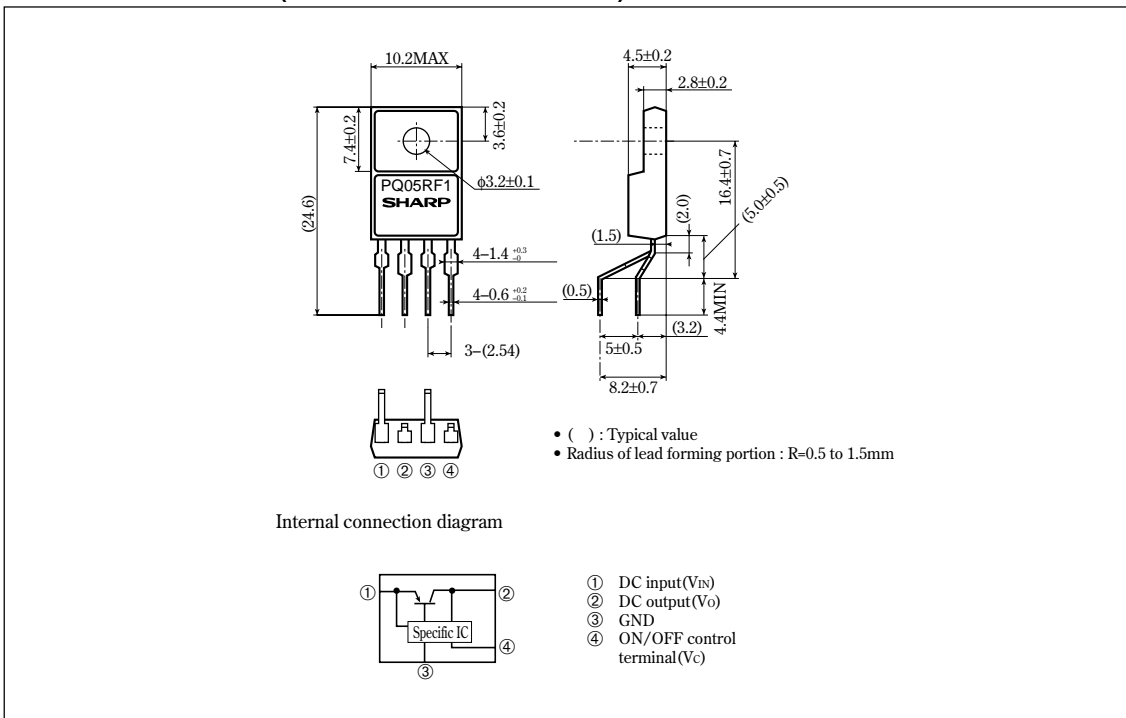
$V_{ref}$  Nearly=1.26V,  $R_1'$  Nearly=390Ω  
 PQ05RF1V :  $R_2'$  Nearly=1.16kΩ  
 PQ09RF1V :  $R_2'$  Nearly=2.40kΩ  
 PQ12RF1V :  $R_2'$  Nearly=3.32kΩ  
 (Note)  $R_1'$  and  $R_2'$  are built in a specific IC.

Model Line-ups for Lead Forming Type

Output voltage	5V output	9V output	12V output
Output voltage precision:±5%	PQ05RF1A	PQ09RF1A	PQ12RF1A
Output voltage precision:±2.5%	PQ05RF1B	PQ09RF1B	PQ12RF1B

Outline Dimensions (PQ05RF1A/PQ05RF1B series)

(Unit : mm)



Note) The value absolute maximum ratings and electrical characteristics is same as ones of PQ05RF1/11 series.

Precautions for Use

(1) Minute adjustment of output voltage (PQ05RF1V series)

If the external resistor is attached to the terminals ②, ③ and ④, minute adjustment of output voltage is possible. (Refer to the example of basic circuit (PQ05RF1V series) and Fig.5 to 7.)

## NOTICE

- The circuit application examples in this publication are provided to explain representative applications of SHARP devices and are not intended to guarantee any circuit design or license any intellectual property rights. SHARP takes no responsibility for any problems related to any intellectual property right of a third party resulting from the use of SHARP's devices.
- Contact SHARP in order to obtain the latest device specification sheets before using any SHARP device. SHARP reserves the right to make changes in the specifications, characteristics, data, materials, structure, and other contents described herein at any time without notice in order to improve design or reliability. Manufacturing locations are also subject to change without notice.
- Observe the following points when using any devices in this publication. SHARP takes no responsibility for damage caused by improper use of the devices which does not meet the conditions and absolute maximum ratings to be used specified in the relevant specification sheet nor meet the following conditions:
  - (i) The devices in this publication are designed for use in general electronic equipment designs such as:
    - Personal computers
    - Office automation equipment
    - Telecommunication equipment [terminal]
    - Test and measurement equipment
    - Industrial control
    - Audio visual equipment
    - Consumer electronics
  - (ii) Measures such as fail-safe function and redundant design should be taken to ensure reliability and safety when SHARP devices are used for or in connection with equipment that requires higher reliability such as:
    - Transportation control and safety equipment (i.e., aircraft, trains, automobiles, etc.)
    - Traffic signals
    - Gas leakage sensor breakers
    - Alarm equipment
    - Various safety devices, etc.
  - (iii) SHARP devices shall not be used for or in connection with equipment that requires an extremely high level of reliability and safety such as:
    - Space applications
    - Telecommunication equipment [trunk lines]
    - Nuclear power control equipment
    - Medical and other life support equipment (e.g., scuba).
- Contact a SHARP representative in advance when intending to use SHARP devices for any "specific" applications other than those recommended by SHARP or when it is unclear which category mentioned above controls the intended use.
- If the SHARP devices listed in this publication fall within the scope of strategic products described in the Foreign Exchange and Foreign Trade Control Law of Japan, it is necessary to obtain approval to export such SHARP devices.
- This publication is the proprietary product of SHARP and is copyrighted, with all rights reserved. Under the copyright laws, no part of this publication may be reproduced or transmitted in any form or by any means, electronic or mechanical, for any purpose, in whole or in part, without the express written permission of SHARP. Express written permission is also required before any use of this publication may be made by a third party.
- Contact and consult with a SHARP representative if there are any questions about the contents of this publication.