

M5 SERIES
P10SG-XXXXE 1 KV ISOLATED 2W REGULATED SINGLE OUTPUT DIP24
Available Inputs:
5, 12 and 24 VDC
Available Outputs:
3.6, 5, 7.2, 9, 12, 15 and 18 VDC

Other specifications please enquire.

Electrical Specifications

(Typical at + 25° C, nominal input voltage, rated output current unless otherwise specified)

Input Specifications

 Voltage range +/- 10 %
 Filter Pi Network

Isolation Specifications

 Rated voltage 1000 Vdc
 Leakage current 1 mA
 Resistance 10⁹ Ohm
 Capacitance 60 pF typ.

Output Specifications

 Voltage accuracy +/- 2 %, max.
 Ripple and noise (at 20 MHz BW) 75 mV p-p, max.
 Short circuit protection Continuous , restart automatic
 Line voltage regulation +/- 0,5 % max.
 Load voltage regulation +/- 0,5 % max.
 Temperature coefficient +/- 0,02 % / °C

General Specifications

 Efficiency 65 % to 85 %
 Switching frequency 125 KHz, typ.

Environmental Specifications

 Operating temperature (ambient) -40°C to +85°C
 Storage temperature - 55 °C to + 125 °C
 Derating See graph
 Humidity Up to 90 %, non condensing
 Cooling Free air convection

Physical Characteristics

 Dimensions 31,75 x 20,32 x 10,16 mm
 1,25 x 0,80 x 0,40 inches
 Weight 12,2 g
 Case material Non conductive black plastic

Examples of Partnumbers/Modelcode

PART NO.	INPUT VOLTAGE (VDC) Nominal	INPUT CURRENT NO LOAD	INPUT CURRENT FULL LOAD	OUTPUT VOLTAGE (VDC)	OUTPUT CURRENT (max. mA)	EFFICIENCY FULL LOAD (% TYP.)
P10SG-0505E	5	50	615	5	400	65
P10SG-0509E	5	47	545	9	200	66
P10SG-1205E	12	40	252	5	400	66
P10SG-1209E	12	38	220	9	200	68
P10SG-1212E	12	35	245	12	167	68
P10SG-2405E	24	16	128	5	400	65

Dimensions

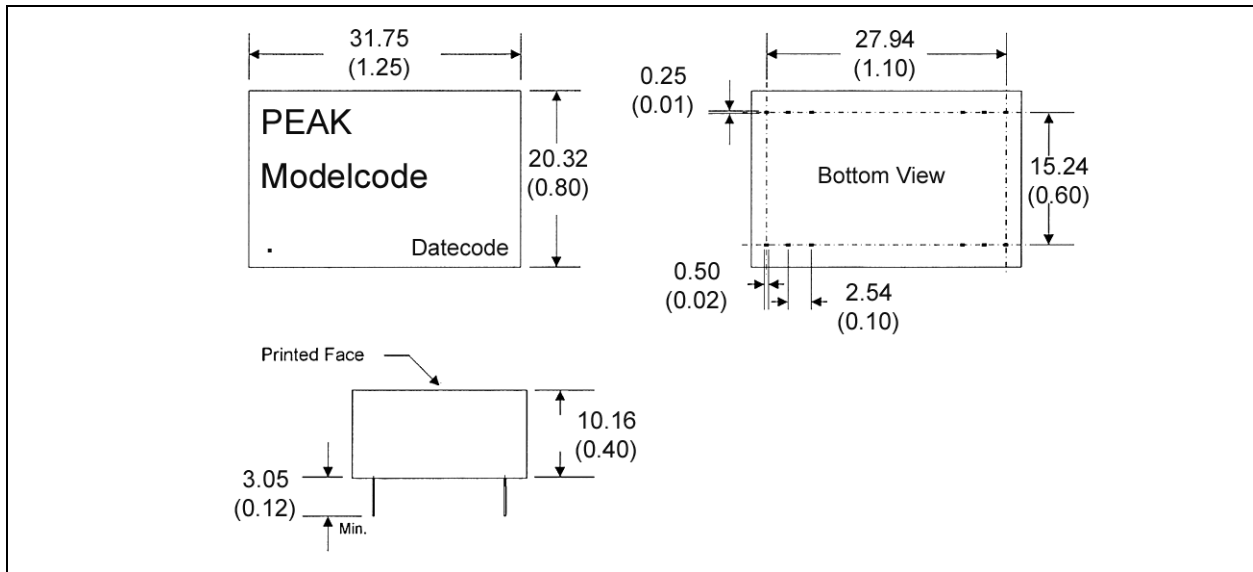

Derating Graph and Pinning

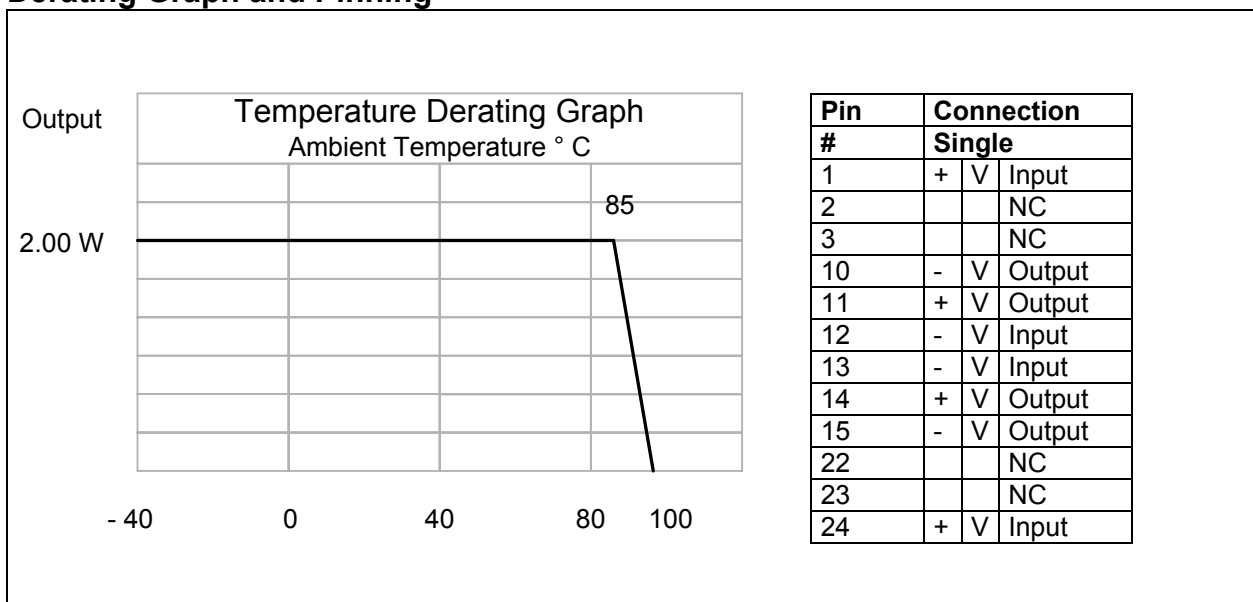

Specification can be changed without notice.

Copyright PEAK electronics GmbH