

## Axial Lead Transient Voltage Suppressors (TVS)

**P4KE Series 6.8 To 600 V 400W**

### Description

The P4KE series is designed specifically to protect sensitive electronic equipment from voltage transients induced by lightning and other transient voltage events.

### Features

- u Glass passivated chip junction in DO-41 Package
- u Low leakage
- u Uni and Bidirectional unit
- u Excellent clamping capability
- u 400W Peak power capability at 10 × 1000µs waveform Repetition rate (duty cycle):0.01%
- u Fast response time: typically less than 1.0ps from 0 Volts to  $V_{BR}$  min
- u Typical  $I_R$  less than 5µA above 12V.
- u High Temperature soldering: 260°C/40 seconds at terminals
- u Typical maximum temperature coefficient  $\Delta V_{BR} = 0.1\% \times V_{BR}@25^\circ\text{C} \times \Delta T$
- u Plastic package has Underwriters Laboratory Flammability 94V-0
- u Matte tin lead-free Plated
- u Halogen free and RoHS compliant
- u Typical failure mode is short from over-specified voltage or current
- u Whisker test is conducted based on JEDEC JESD201A per its table 4a and 4c
- u IEC-61000-4-2 ESD 15kV(Air), 8kV (Contact)
- u ESD protection of data lines in accordance with IEC 61000-4-2 (IEC801-2)
- u EFT protection of data lines in accordance with IEC 61000-4-4 (IEC801-4)

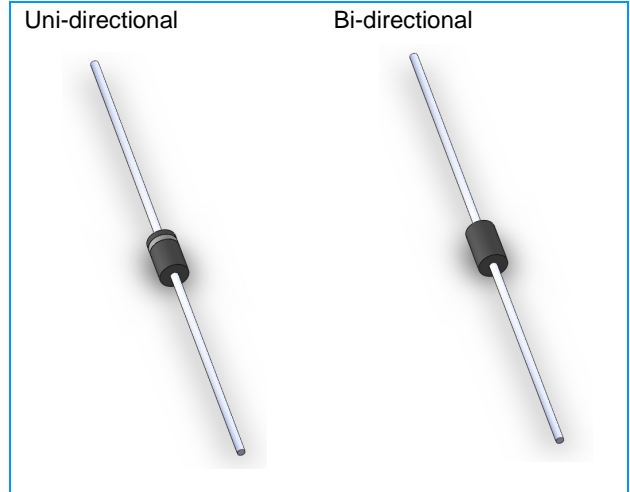

### Functional Diagram

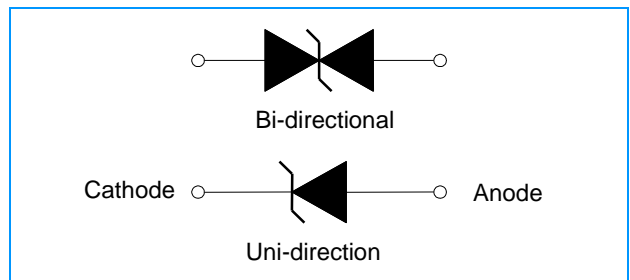

### Applications

TVS devices are ideal for the protection of I/O interfaces,  $V_{CC}$  bus and other vulnerable circuits used in Telecom, Computer, Industrial and Consumer electronic applications.

### Maximum Ratings ( $T_A=25^\circ\text{C}$ unless otherwise noted)

Parameter	Symbol	Value	Unit
Peak Pulse Power Dissipation with a 10/1000µs waveform (Fig.1)(Note 1), (Note 2)	$P_{PPM}$	400	Watts
Peak Pulse Current with a 10/1000µs waveform.(Note1, Fig.3)	$I_{PP}$	See Next Table	Amps
Power Dissipation on Infinite Heat Sink at $T_L=75^\circ\text{C}$	$P_{M(AV)}$	1.0	Watt
Peak Forward Surge Current, 8.3ms Single Half Sine Wave (Note 3)	$I_{FSM}$	40	Amps
Maximum Instantaneous Forward Voltage at 25A for Unidirectional Only (Note 4)	$V_F$	3.5/5.0	Voltage
Operating junction and Storage Temperature Range.	$T_J, T_{STG}$	-55 to +150	$^\circ\text{C}$

### Notes:

1. Non-repetitive current pulse, per Fig. 3 and derated above  $T_A = 25^\circ\text{C}$  per Fig. 2.
2. Mounted on 5.0mm x 5.0mm (0.03mm thick) Copper Pads to each terminal.
3. 8.3ms single half sine-wave, or equivalent square wave, Duty cycle = 4 pulses per minutes maximum.
4.  $V_F < 3.5\text{V}$  for  $V_{BR} < 200\text{V}$  and  $V_F < 6.5\text{V}$  for  $V_{BR} > 201\text{V}$ .

## Axial Lead Transient Voltage Suppressors (TVS)

**P4KE Series 6.8 To 600 V 400W**
**Electrical Characteristics (T<sub>A</sub>=25°C unless otherwise noted)**

Part Number		Reverse Stand-Off Voltage V <sub>RWM</sub> (V)	Breakdown Voltage V <sub>BR</sub> (V) @I <sub>T</sub>		Test Current I <sub>T</sub> (mA)	Maximum Clamping Voltage V <sub>C</sub> @I <sub>PP</sub> (V)	Maximum Peak Pulse Current I <sub>PP</sub> (A)	Maximum Reverse Leakage I <sub>R</sub> @V <sub>RWM</sub> (μA)
Uni	Bi		MIN	MAX				
P4KE6.8	P4KE6.8C	5.5	6.12	7.48	10	10.8	37.04	1000
P4KE6.8A	P4KE6.8CA	5.8	6.46	7.14	10	10.5	38.10	1000
P4KE7.5	P4KE7.5C	6.1	6.75	8.25	10	11.7	34.19	500
P4KE7.5A	P4KE7.5CA	6.4	7.13	7.88	10	11.3	35.40	500
P4KE8.2	P4KE8.2C	6.6	7.38	9.02	10	12.5	32.00	200
P4KE8.2A	P4KE8.2CA	7.0	7.79	8.61	10	12.1	33.06	200
P4KE9.1	P4KE9.1C	7.4	8.19	10.01	1	13.8	28.99	50
P4KE9.1A	P4KE9.1CA	7.8	8.65	9.56	1	13.4	29.85	50
P4KE10	P4KE10C	8.1	9.00	11.00	1	15.0	26.67	10
P4KE10A	P4KE10CA	8.6	9.50	10.50	1	14.5	27.59	10
P4KE11	P4KE11C	8.9	9.90	12.10	1	16.2	24.69	5
P4KE11A	P4KE11CA	9.4	10.45	11.55	1	15.6	25.64	5
P4KE12	P4KE12C	9.7	10.80	13.20	1	17.3	23.12	5
P4KE12A	P4KE12CA	10.2	11.40	12.60	1	16.7	23.95	5
P4KE13	P4KE13C	10.5	11.70	14.30	1	19.0	21.05	5
P4KE13A	P4KE13CA	11.1	12.35	13.65	1	18.2	21.98	5
P4KE15	P4KE15C	12.1	13.50	16.50	1	22.0	18.18	5
P4KE15A	P4KE15CA	12.8	14.25	15.75	1	21.2	18.87	5
P4KE16	P4KE16C	12.9	14.40	17.60	1	23.5	17.02	5
P4KE16A	P4KE16CA	13.6	15.20	16.80	1	22.5	17.78	5
P4KE18	P4KE18C	14.5	16.20	19.80	1	26.5	15.09	5
P4KE18A	P4KE18CA	15.3	17.10	18.90	1	25.2	15.87	5
P4KE20	P4KE20C	16.2	18.00	22.00	1	29.1	13.75	5
P4KE20A	P4KE20CA	17.1	19.00	21.00	1	27.7	14.44	5
P4KE22	P4KE22C	17.8	19.80	24.20	1	31.9	12.54	5
P4KE22A	P4KE22CA	18.8	20.90	23.10	1	30.6	13.07	5
P4KE24	P4KE24C	19.4	21.60	26.40	1	34.7	11.53	5
P4KE24A	P4KE24CA	20.5	22.80	25.20	1	33.2	12.05	5
P4KE27	P4KE27C	21.8	24.30	29.70	1	39.1	10.23	5
P4KE27A	P4KE27CA	23.1	25.65	28.35	1	37.5	10.67	5
P4KE30	P4KE30C	24.3	27.00	33.00	1	43.5	9.20	5
P4KE30A	P4KE30CA	25.6	28.50	31.50	1	41.4	9.66	5
P4KE33	P4KE33C	26.8	29.70	36.30	1	47.7	8.39	5
P4KE33A	P4KE33CA	28.2	31.35	34.65	1	45.7	8.75	5
P4KE36	P4KE36C	29.1	32.40	39.60	1	52.0	7.69	5
P4KE36A	P4KE36CA	30.8	34.20	37.80	1	49.9	8.02	5
P4KE39	P4KE39C	31.6	35.10	42.90	1	56.4	7.09	5
P4KE39A	P4KE39CA	33.3	37.05	40.95	1	53.9	7.42	5
P4KE43	P4KE43C	34.8	38.70	47.30	1	61.9	6.46	5
P4KE43A	P4KE43CA	36.8	40.85	45.15	1	59.3	6.75	5
P4KE47	P4KE47C	38.1	42.30	51.70	1	67.8	5.90	5
P4KE47A	P4KE47CA	40.2	44.65	49.35	1	64.8	6.17	5
P4KE51	P4KE51C	41.3	45.90	56.10	1	73.5	5.44	5
P4KE51A	P4KE51CA	43.6	48.45	53.55	1	70.1	5.71	5
P4KE56	P4KE56C	45.4	50.40	61.60	1	80.5	4.97	5
P4KE56A	P4KE56CA	47.8	53.20	58.80	1	77.0	5.19	5
P4KE62	P4KE62C	50.2	55.80	68.20	1	89.0	4.49	5
P4KE62A	P4KE62CA	53.0	58.90	65.10	1	85.0	4.71	5
P4KE68	P4KE68C	55.1	61.20	74.80	1	98.0	4.08	5
P4KE68A	P4KE68CA	58.1	64.60	71.40	1	92.0	4.35	5
P4KE75	P4KE75C	60.7	67.50	82.50	1	108.0	3.70	5
P4KE75A	P4KE75CA	64.1	71.25	78.75	1	103.0	3.88	5
P4KE82	P4KE82C	66.4	73.80	90.20	1	118.0	3.39	5
P4KE82A	P4KE82CA	70.1	77.90	86.10	1	113.0	3.54	5

## Axial Lead Transient Voltage Suppressors (TVS)

**P4KE Series 6.8 To 600 V 400W**
**Electrical Characteristics (T<sub>A</sub>=25°C unless otherwise noted) (Continue)**

Part Number		Reverse Stand-Off Voltage V <sub>RWM</sub> (V)	Breakdown Voltage V <sub>BR</sub> (V) @I <sub>T</sub>		Test Current I <sub>T</sub> (mA)	Maximum Clamping Voltage V <sub>C</sub> @I <sub>PP</sub> (V)	Maximum Peak Pulse Current I <sub>PP</sub> (A)	Maximum Reverse Leakage I <sub>R</sub> @V <sub>RWM</sub> (μA)
Uni	Bi		MIN	MAX				
P4KE91	P4KE91C	73.7	81.90	100.10	1	131.0	3.05	5
P4KE91A	P4KE91CA	77.8	86.45	95.55	1	125.0	3.20	5
P4KE100	P4KE100C	81.0	90.00	110.00	1	144.0	2.78	5
P4KE100A	P4KE100CA	85.5	95.00	105.00	1	137.0	2.92	5
P4KE110	P4KE110C	89.2	99.00	121.00	1	158.0	2.53	5
P4KE110A	P4KE110CA	94.0	104.50	115.50	1	152.0	2.63	5
P4KE120	P4KE120C	97.2	108.00	132.00	1	173.0	2.31	5
P4KE120A	P4KE120CA	102.0	114.00	126.00	1	165.0	2.42	5
P4KE130	P4KE130C	105.0	117.00	143.00	1	187.0	2.14	5
P4KE130A	P4KE130CA	111.0	123.50	136.50	1	179.0	2.23	5
P4KE150	P4KE150C	121.0	135.00	165.00	1	215.0	1.86	5
P4KE150A	P4KE150CA	128.0	142.50	157.50	1	207.0	1.93	5
P4KE160	P4KE160C	130.0	144.00	176.00	1	230.0	1.74	5
P4KE160A	P4KE160CA	136.0	152.00	168.00	1	219.0	1.83	5
P4KE170	P4KE170C	138.0	153.00	187.00	1	244.0	1.64	5
P4KE170A	P4KE170CA	145.0	161.50	178.50	1	234.0	1.71	5
P4KE180	P4KE180C	146.0	162.00	198.00	1	258.0	1.55	5
P4KE180A	P4KE180CA	154.0	171.00	189.00	1	246.0	1.63	5
P4KE200	P4KE200C	162.0	180.00	220.00	1	287.0	1.39	5
P4KE200A	P4KE200CA	171.0	190.00	210.00	1	274.0	1.46	5
P4KE220	P4KE220C	175.0	198.00	242.00	1	344.0	1.16	5
P4KE220A	P4KE220CA	185.0	209.00	231.00	1	328.0	1.22	5
P4KE250	P4KE250C	202.0	225.00	275.00	1	360.0	1.11	5
P4KE250A	P4KE250CA	214.0	237.50	262.50	1	344.0	1.16	5
P4KE300	P4KE300C	243.0	270.00	330.00	1	430.0	0.93	5
P4KE300A	P4KE300CA	256.0	285.00	315.00	1	414.0	0.97	5
P4KE350	P4KE350C	284.0	315.00	385.00	1	504.0	0.79	5
P4KE350A	P4KE350CA	299.3	332.50	367.50	1	482.0	0.83	5
P4KE380	P4KE380C	308.6	342.00	418.00	1	547.2	0.73	5
P4KE380A	P4KE380CA	324.9	361.00	399.00	1	524.4	0.76	5
P4KE400	P4KE400C	324.8	360.00	440.00	1	576.0	0.69	5
P4KE400A	P4KE400CA	342.0	380.00	420.00	1	552.0	0.72	5
P4KE440	P4KE440C	357.3	396.00	484.00	1	633.6	0.63	5
P4KE440A	P4KE440CA	376.2	418.00	462.00	1	607.2	0.66	5
P4KE500	P4KE500C	406.0	450.00	550.00	1	720.0	0.56	5
P4KE500A	P4KE500CA	427.5	475.00	525.00	1	690.0	0.58	5
P4KE520	P4KE520C	422.2	468.00	572.00	1	748.8	0.53	5
P4KE520A	P4KE520CA	444.6	494.00	546.00	1	717.6	0.56	5
P4KE550	P4KE550C	446.6	495.00	605.00	1	792.0	0.51	5
P4KE550A	P4KE550CA	470.3	522.50	577.50	1	759.0	0.53	5
P4KE600	P4KE600C	487.2	540.00	660.00	1	864.0	0.46	5
P4KE600A	P4KE600CA	513.0	570.00	630.00	1	828.0	0.48	5

**Note:**

1. Suffix 'A' denotes 5% tolerance device. Without 'A' denotes 10% tolerance device
2. Add suffix 'C' or 'CA' after part number to specify Bi-directional devices
3. For Bi-Directional devices having V<sub>R</sub> of 10 volts and under, the I<sub>R</sub> limit is double

# Axial Lead Transient Voltage Suppressors (TVS)

**P4KE Series 6.8 To 600 V 400W**

Ratings and Characteristic Curves ( $T_A=25^\circ\text{C}$  unless otherwise noted)

**Figure 1 - Peak Pulse Power Rating Curve**

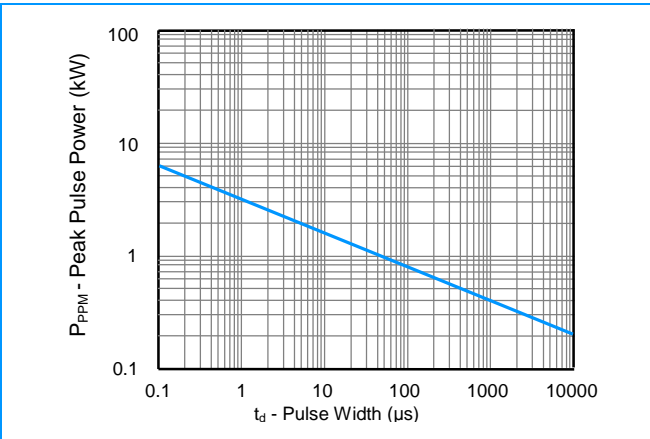

**Figure 2 - Pulse Derating Curve**

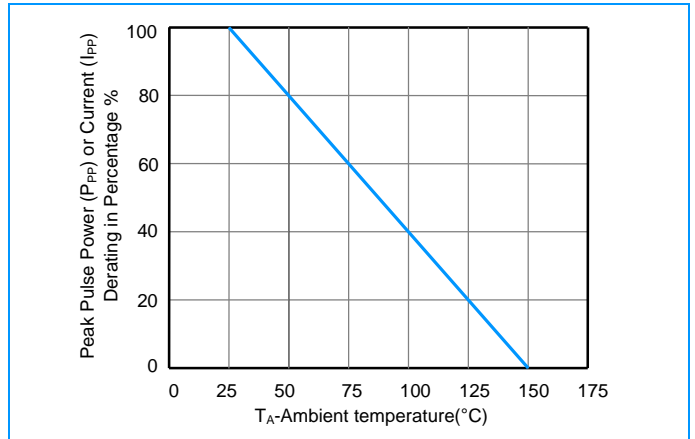

**Figure 3 - Pulse Waveform**

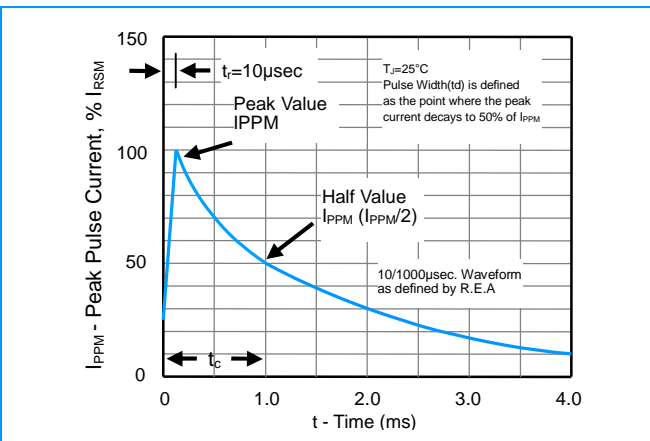

**Figure 4 - Typical Junction Capacitance**

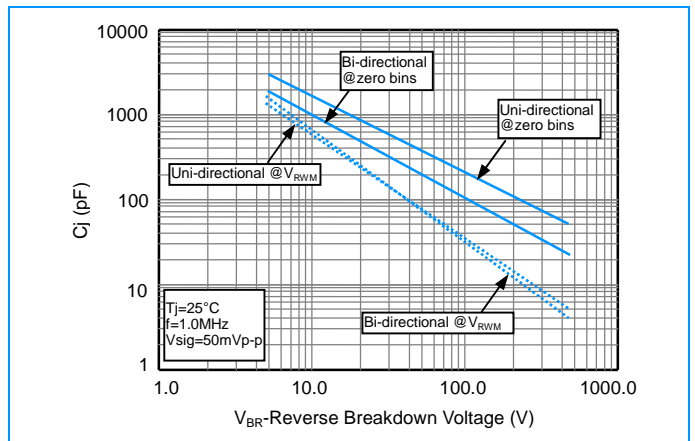

**Figure 5 - Steady State Power Derating Curve**

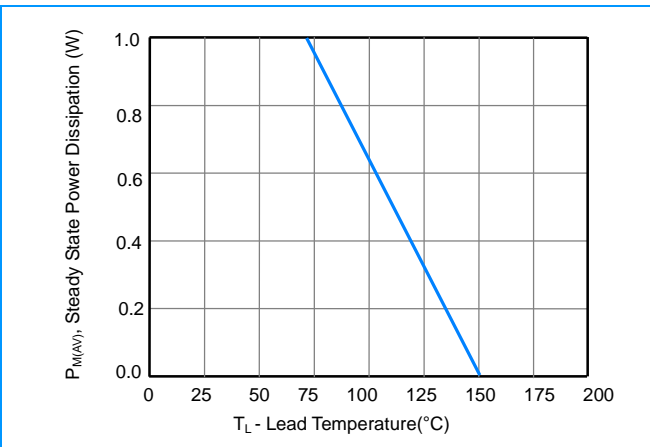

**Figure 6 - Maximum Non-Repetitive Surge Current**

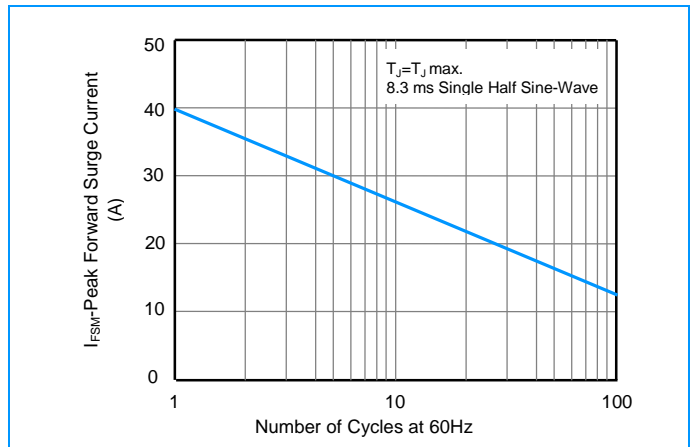

## Axial Lead Transient Voltage Suppressors (TVS)

**P4KE Series 6.8 To 600 V 400W**

### I-V Curve Characteristics

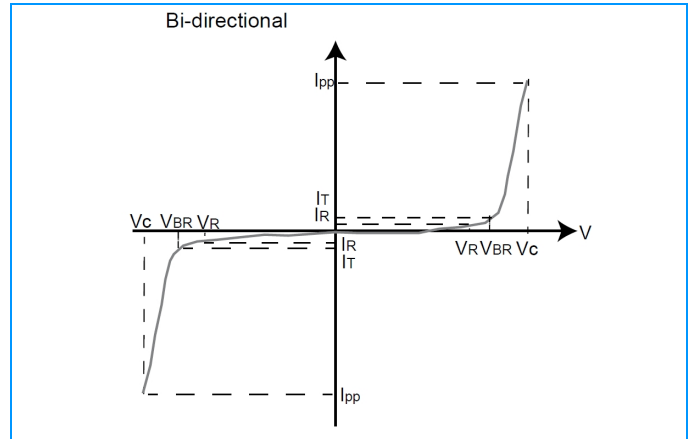
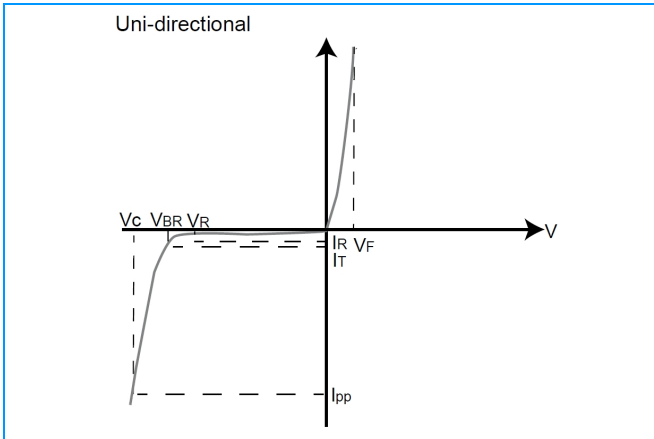

### Physical Specifications

<b>Weight</b>	0.012 ounce, 0.3 gram
<b>Case</b>	JEDEC DO-204AL (DO-41) Molded Plastic over glass passivated junction
<b>Polarity</b>	Color band denotes cathode except Bipolar
<b>Terminal</b>	Matte Tin-plated leads, Solderable per JESD22-B102D

### Environmental Specifications

<b>Temperature Cycle</b>	JESD22-A104
<b>Pressure Cooker</b>	JESD22-A102
<b>High Temp. Storage</b>	JESD22-A103
<b>HTRB</b>	JESD22-A108
<b>Thermal Shock</b>	JESD22-A106

### Soldering Parameters

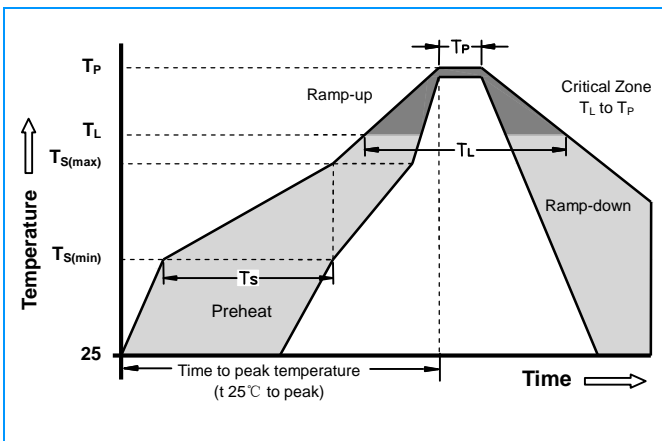

Reflow Condition		Lead-free assembly
Pre Heat	-Temperature Min ( $T_{s(min)}$ )	150°C
	-Temperature Max ( $T_{s(max)}$ )	200°C
	- Time (min to max) ( $t_s$ )	60 -180 Seconds
Average ramp up rate ( Liquidus Temp $T_L$ ) to peak		3°C/second max
$T_{s(max)}$ to $T_L$ - Ramp-up Rate		3°C/second max
Reflow	- Temperature ( $T_L$ ) (Liquidus)	217°C
	- Time (min to max) ( $t_s$ )	60 -150 Seconds
Peak Temperature ( $T_P$ )		260 +0/-5°C
Time within 5°C of actual peak Temperature ( $t_p$ )		20 -40 Seconds
Ramp-down Rate		6°C/second max
Time 25°C to peak Temperature ( $T_P$ )		8 minutes Max
Do not exceed		280°C

## Axial Lead Transient Voltage Suppressors (TVS)

**P4KE Series 6.8 To 600 V 400W**

### Dimensions

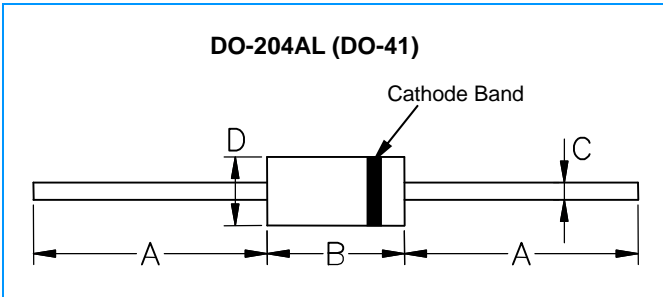

Dimensions	Inches		Millimeters	
	Min	Max	Min	Max
<b>A</b>	1.000	-	25.40	-
<b>B</b>	0.165	0.205	4.19	5.21
<b>C</b>	0.028	0.033	0.71	0.84
<b>D</b>	0.090	0.117	2.29	2.97

### Part Numbering

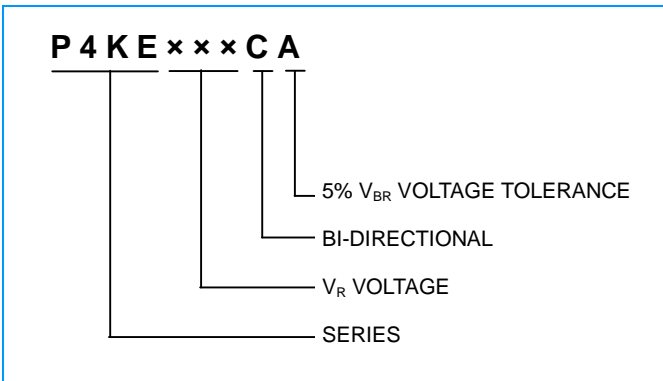

### Packaging

Part Number	Component Package	Quantity	Packaging Option
P4KEXXXXX	<b>DO-204AL (DO-41)</b>	2000	Box

### Packaging Dimensions Unit: Inches (Millimeters)

