

P4KE6.8 THRU P4KE440CA

TRANSZORB™ TRANSIENT VOLTAGE SUPPRESSOR
Breakdown Voltage - 6.8 to 440 Volts Peak Pulse Power - 400 Watts

FEATURES

- ◆ Plastic package has Underwriters Laboratory Flammability Classification 94V-0
- ◆ Glass passivated junction
- ◆ 400W peak pulse power capability with a 10/1000µs waveform, repetition rate (duty cycle): 0.01%
- ◆ Excellent clamping capability
- ◆ Low incremental surge resistance
- ◆ Fast response time: typically less than 1.0ps from 0 Volts to $V_{(BR)}$ for uni-directional and 5.0ns for bi-directional types
- ◆ Devices with $V_{(BR)} \geq 10V$ I_D are typically I_D less than 1.0µA
- ◆ High temperature soldering guaranteed: 265°C/10 seconds, 0.375" (9.5mm) lead length, 5lbs. (2.3 kg) tension

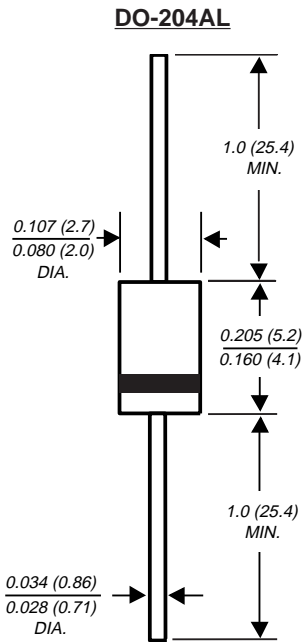

Dimensions are in inches and (millimeters)

MECHANICAL DATA

Case: JEDEC DO-204AL molded plastic body over passivated junction

Terminals: Axial leads, solderable per MIL-STD-750, Method 2026

Polarity: For uni-directional types the color band denotes the cathode, which is positive with respect to the anode under normal TVS operation

Mounting Position: Any

Weight: 0.012 ounce, 0.3 gram

DEVICES FOR BIDIRECTIONAL APPLICATIONS

For bi-directional use C or CA suffix for types P4KE7.5 thru types P4KE440 (e.g. P4KE7.5CA, P4KE440CA).
 Electrical characteristics apply in both directions.

MAXIMUM RATINGS AND CHARACTERISTICS

Ratings at 25°C ambient temperature unless otherwise specified.

	SYMBOL	VALUE	UNITS
Peak power dissipation with a 10/1000µs waveform (NOTE 1, FIG. 1)	PPPM	Minimum 400	Watts
Peak pulse current with a 10/1000µs waveform (NOTE 1)	IPPM	SEE TABLE 1	Amps
Steady state power dissipation at $T_L=75^\circ\text{C}$ lead lengths 0.375" (9.5mm) (NOTE 2)	PM(AV)	1.0	Watts
Peak forward surge current, 8.3ms single half sine-wave superimposed on rated load (JEDEC Method) (NOTE 3)	IFSM	40.0	Amps
Maximum instantaneous forward voltage at 25A for unidirectional only (NOTE 4)	V_F	3.5/5.0	Volts
Operating junction and storage temperature range	T_J, T_{STG}	-55 to +175	°C

NOTES:

- (1) Non-repetitive current pulse, per Fig. 3 and derated above $T_A=25^\circ\text{C}$ per Fig. 2
- (2) Mounted on copper pad area of 1.6 x 1.6" (40 x 40mm) per Fig. 5
- (3) Measured on 8.3ms single half sine-wave or equivalent square wave, duty cycle=4 pulses per minute maximum
- (4) $V_F=3.5$ Volt max. for devices of $V_{(BR)} \leq 220V$, and $V_F=5.0$ Volt max. for devices of $V_{(BR)} > 220V$

ELECTRICAL CHARACTERISTICS at (T_A=25°C unless otherwise noted) TABLE 1

Device Type	Breakdown Voltage V _(BR) (Volts) (NOTE 1)		Test Current at I _T (mA)	Stand-off Voltage V _{WM} (Volts)	Maximum Reverse Leakage at V _{WM} I _D (NOTE3) (μA)	Maximum Peak Pulse Current I _{PPM} (NOTE 2) (Amps)	Maximum Clamping Voltage at I _{PPM} V _c (Volts)	Maximum Temperature Coefficient of V _(BR) (% / °C)
	MIN	MAX						
P4KE6.8	6.12	7.48	10	5.50	1000	37.0	10.8	0.057
P4KE6.8A	6.45	7.14	10	5.80	1000	38.1	10.5	0.057
P4KE7.5	6.75	8.25	10	6.05	500	34.2	11.7	0.061
P4KE7.5A	7.13	7.88	10	6.40	500	35.4	11.3	0.061
P4KE8.2	7.38	9.02	10	6.63	200	32.0	12.5	0.065
P4KE8.2A	7.79	8.61	10	7.02	200	33.1	12.1	0.06
P4KE9.1	8.19	10.0	1.0	7.37	50	29.0	13.8	0.068
P4KE9.1A	8.65	9.55	1.0	7.78	50	29.9	13.4	0.068
P4KE10	9.00	11.0	1.0	8.10	10	26.7	15.0	0.073
P4KE10A	9.50	10.5	1.0	8.55	10	27.6	14.5	0.073
P4KE11	9.90	12.1	1.0	8.92	5.0	24.7	16.2	0.075
P4KE11A	10.5	11.6	1.0	9.40	5.0	25.6	15.6	0.075
P4KE12	10.8	13.2	1.0	9.72	5.0	23.1	17.3	0.076
P4KE12A	11.4	12.6	1.0	10.2	5.0	24.0	16.7	0.078
P4KE13	11.7	14.3	1.0	10.5	5.0	21.1	19.0	0.081
P4KE13A	12.4	13.7	1.0	11.1	5.0	22.0	18.2	0.081
P4KE15	13.5	16.5	1.0	12.1	5.0	18.2	22.0	0.084
P4KE15A	14.3	15.8	1.0	12.8	5.0	18.9	21.2	0.084
P4KE16	14.4	17.6	1.0	12.9	5.0	17.0	23.5	0.086
P4KE16A	15.2	16.8	1.0	13.6	5.0	17.8	22.5	0.086
P4KE18	16.2	19.8	1.0	14.5	5.0	15.1	26.5	0.088
P4KE18A	17.1	18.9	1.0	15.3	5.0	15.9	25.2	0.088
P4KE20	18.0	22.0	1.0	16.2	5.0	13.7	29.1	0.090
P4KE20A	19.0	21.0	1.0	17.1	5.0	14.4	27.7	0.090
P4KE22	19.8	24.2	1.0	17.8	5.0	12.5	31.9	0.092
P4KE22A	20.9	23.1	1.0	18.8	5.0	13.1	30.6	0.092
P4KE24	21.6	26.4	1.0	19.4	5.0	11.5	34.7	0.094
P4KE24A	22.8	25.2	1.0	20.5	5.0	12.0	33.2	0.094
P4KE27	24.3	29.7	1.0	21.8	5.0	10.2	39.1	0.096
P4KE27A	25.7	28.4	1.0	23.1	5.0	10.7	37.5	0.096
P4KE30	27.0	33.0	1.0	24.3	5.0	9.2	43.5	0.097
P4KE30A	28.5	31.5	1.0	25.6	5.0	9.7	41.4	0.097
P4KE33	29.7	36.3	1.0	26.8	5.0	8.4	47.7	0.098
P4KE33A	31.4	34.7	1.0	28.2	5.0	8.8	45.7	0.098
P4KE36	32.4	39.6	1.0	29.1	5.0	7.7	52.0	0.099
P4KE36A	34.2	37.8	1.0	30.8	5.0	8.0	49.9	0.099
P4KE39	35.1	42.9	1.0	31.6	5.0	7.1	56.4	0.100
P4KE39A	37.1	41.0	1.0	33.3	5.0	7.4	53.9	0.100
P4KE43	38.7	47.3	1.0	34.8	5.0	6.5	61.9	0.101
P4KE43A	40.9	45.2	1.0	36.8	5.0	6.7	59.3	0.101
P4KE47	42.3	51.7	1.0	38.1	5.0	5.9	67.8	0.101
P4KE47A	44.7	49.4	1.0	40.2	5.0	6.2	64.8	0.101
P4KE51	45.9	56.1	1.0	41.3	5.0	5.4	73.5	0.102
P4KE51A	48.5	53.6	1.0	43.6	5.0	5.7	70.1	0.102
P4KE56	50.4	61.6	1.0	45.4	5.0	5.0	80.5	0.103
P4KE56A	53.2	58.8	1.0	47.8	5.0	5.2	77.0	0.103

ELECTRICAL CHARACTERISTICS at (T_A=25°C unless otherwise noted) TABLE 1 (Cont'd)

Device Type	Breakdown Voltage V _(BR) Volts (NOTE 1)		Test Current at I _T (mA)	Stand-off Voltage V _{WM} (Volts)	Maximum Reverse Leakage at V _{WM} I _D (NOTE3) (μA)	Maximum Peak Pulse Current I _{PPM} (NOTE 2) (Amps)	Maximum Clamping Voltage at I _{PPM} V _c (Volts)	Maximum Temperature Coefficient of V _(BR) (% / °C)
	MIN	MAX						
P4KE62	55.8	68.2	1.0	50.2	5.0	4.5	89.0	0.104
P4KE62A	58.9	65.1	1.0	53.0	5.0	4.7	85.0	0.104
P4KE68	61.2	74.8	1.0	55.1	5.0	4.1	98.0	0.104
P4KE68A	64.6	71.4	1.0	58.1	5.0	4.3	92.0	0.104
P4KE75	67.5	82.5	1.0	60.7	5.0	3.7	108	0.105
P4KE75A	71.3	78.8	1.0	64.1	5.0	3.9	103	0.105
P4KE82	73.8	90.2	1.0	66.4	5.0	3.4	118	0.105
P4KE82A	77.9	86.1	1.0	70.1	5.0	3.5	113	0.105
P4KE91	81.9	100	1.0	73.7	5.0	3.1	131	0.106
P4KE91A	86.5	95.5	1.0	77.8	5.0	3.2	125	0.106
P4KE100	90.0	110	1.0	81.0	5.0	2.8	144	0.106
P4KE100A	95.0	105	1.0	85.5	5.0	2.9	137	0.106
P4KE110	99.0	121	1.0	89.2	5.0	2.5	158	0.107
P4KE110A	105	116	1.0	94.0	5.0	2.6	152	0.107
P4KE120	108	132	1.0	97.2	5.0	2.3	173	0.107
P4KE120A	114	126	1.0	102	5.0	2.4	165	0.107
P4KE130	117	143	1.0	105	5.0	2.1	187	0.107
P4KE130A	124	137	1.0	111	5.0	2.2	179	0.107
P4KE150	135	165	1.0	121	5.0	1.9	215	0.108
P4KE150A	143	158	1.0	128	5.0	1.9	207	0.108
P4KE160	144	176	1.0	130	5.0	1.7	230	0.108
P4KE160A	152	168	1.0	136	5.0	1.8	219	0.108
P4KE170	153	187	1.0	138	5.0	1.6	244	0.108
P4KE170A	162	179	1.0	145	5.0	1.7	234	0.108
P4KE180	162	198	1.0	146	5.0	1.6	258	0.108
P4KE180A	171	189	1.0	154	5.0	1.6	246	0.108
P4KE200	180	220	1.0	162	5.0	1.4	287	0.108
P4KE200A	190	210	1.0	171	5.0	1.5	274	0.108
P4KE220	198	242	1.0	175	5.0	1.2	344	0.108
P4KE220A	209	231	1.0	185	5.0	1.2	328	0.108
P4KE250	225	275	1.0	202	5.0	1.1	360	0.110
P4KE250A	237	263	1.0	214	5.0	1.2	344	0.110
P4KE300	270	330	1.0	243	5.0	0.93	430	0.110
P4KE300A	285	315	1.0	256	5.0	1.0	414	0.110
P4KE350	315	385	1.0	284	5.0	0.79	504	0.110
P4KE350A	333	368	1.0	300	5.0	0.83	482	0.110
P4KE400	360	440	1.0	324	5.0	0.70	574	0.110
P4KE400A	380	420	1.0	342	5.0	0.73	548	0.110
P4KE440	396	484	1.0	356	5.0	0.63	631	0.110
P4KE440A	418	462	1.0	376	5.0	0.66	602	0.110

NOTES:

- (1) V_(BR) measured after I_T applied for 300μs, I_T=square wave pulse or equivalent
- (2) Surge current waveform per Fig. 3 and derated per Fig. 2
- (3) For bidirectional types having V_{WM} of 10 volts and less, the I_D limit is doubled
- (4) All terms and symbols are consistent with ANSI/IEEE C62.35

RATINGS AND CHARACTERISTIC CURVES P4KE6.8 THRU P4KE440CA

FIG. 1 - PEAK PULSE POWER RATING CURVE

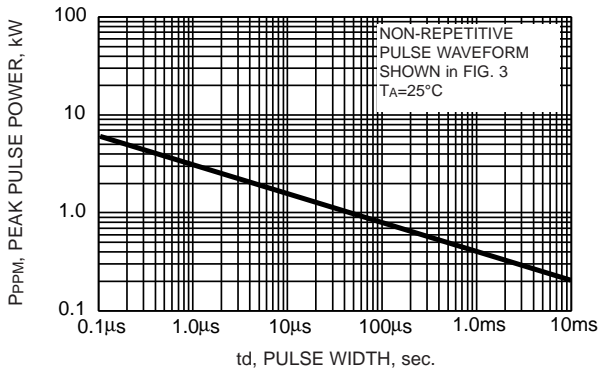

FIG. 2 - PULSE DERATING CURVE

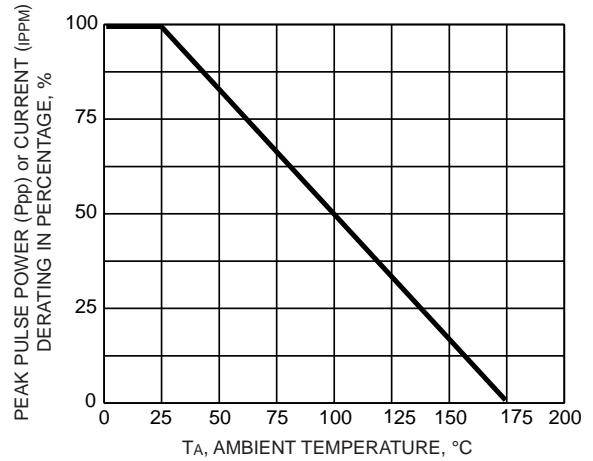

FIG. 3 - PULSE WAVEFORM

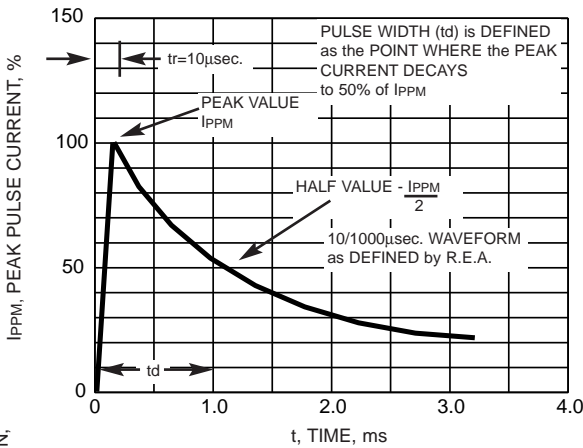

FIG. 4 - TYPICAL JUNCTION CAPACITANCE UNIDIRECTIONAL

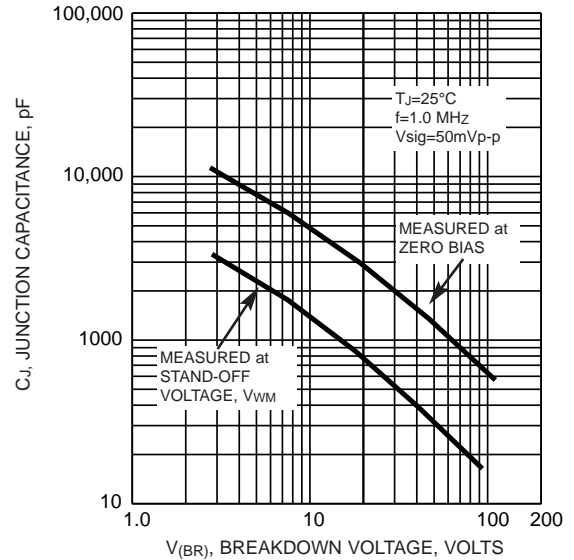

FIG. 5 - STEADY STATE POWER DERATING CURVE

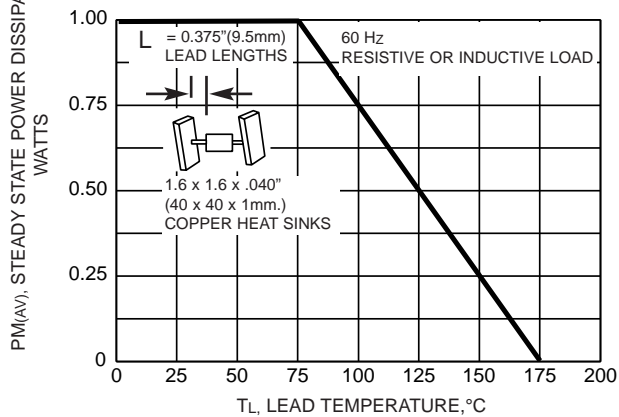

FIG. 6 - MAXIMUM NON-REPETITIVE FORWARD SURGE CURRENT UNIDIRECTIONAL ONLY

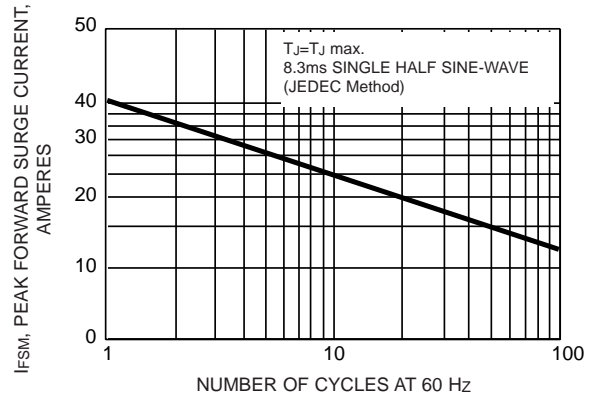

FIG. 7 - TYPICAL REVERSE LEAKAGE CHARACTERISTICS

