

Surface Mount Transient Voltage Suppressors (TVS)

P4SMA Series 6.8 To 600 V 400W

Description

The P4SMA series is designed specifically to protect sensitive electronic equipment from voltage transients induced by lightning and other transient voltage events.

Features

- u For surface mounted applications in order to optimize board space
- u Low leakage
- u Uni and Bidirectional unit
- u Glass passivated junction
- u Low inductance
- u Excellent clamping capability
- u 400W Peak power capability at 10 × 1000μs waveform Repetition rate (duty cycle):0.01%
- u Fast response time: typically less than 1.0ps from 0 Volts to V_{BR} min
- u Typical I_R less than 5μA above 12V.
- u High Temperature soldering: 260°C/40 seconds at terminals
- u Typical maximum temperature coefficient $\Delta V_{BR} = 0.1\% \times V_{BR@25^\circ C} \times \Delta T$
- u Plastic package has Underwriters Laboratory Flammability 94V-0
- u Matte tin lead-free Plated
- u Halogen free and RoHS compliant
- u Typical failure mode is short from over-specified voltage or current
- u Whisker test is conducted based on JEDEC JESD201A per its table 4a and 4c
- u IEC-61000-4-2 ESD 15kV(Air), 8kV (Contact)
- u ESD protection of data lines in accordance with IEC 61000-4-2 (IEC801-2)
- u EFT protection of data lines in accordance with IEC 61000-4-4 (IEC801-4)

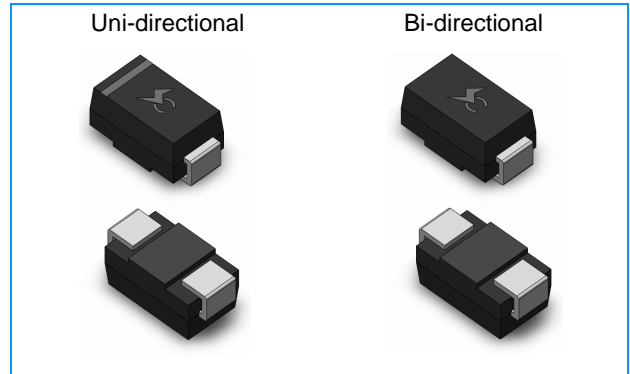

Functional Diagram

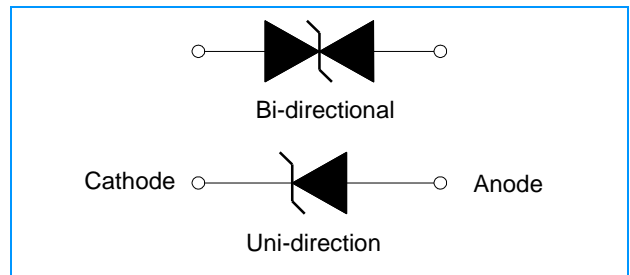

Agency Approvals

AGENCY	AGENCY FILE NUMBER
	E341027

Applications

TVS devices are ideal for the protection of I/O interfaces, V_{CC} bus and other vulnerable circuits used in Telecom, Computer, Industrial and Consumer electronic applications.

Maximum Ratings ($T_A=25^\circ C$ unless otherwise noted)

Parameter	Symbol	Value	Unit
Peak Pulse Power Dissipation with a 10/1000μs waveform (Fig.1)(Note 1), (Note 2)	P_{PPM}	400	Watts
Peak Pulse Current with a 10/1000μs waveform.(Note1, Fig.3)	I_{PP}	See Next Table	Amps
Power Dissipation on Infinite Heat Sink at $T_L=75^\circ C$	$P_{M(AV)}$	1.0	Watt
Peak Forward Surge Current, 8.3ms Single Half Sine Wave (Note 3)	I_{FSM}	40	Amps
Maximum Instantaneous Forward Voltage at 25A for Unidirectional Only (Note 4)	V_F	3.5/5.0	Voltage
Operating junction and Storage Temperature Range.	T_J, T_{STG}	-55 to +150	$^\circ C$

Notes:

1. Non-repetitive current pulse, per Fig. 3 and derated above $T_A = 25^\circ C$ per Fig. 2.
2. Mounted on 5.0mm x 5.0mm (0.03mm thick) Copper Pads to each terminal.
3. 8.3ms single half sine-wave, or equivalent square wave, Duty cycle = 4 pulses per minutes maximum.
4. $V_F < 3.5V$ for $V_{BR} < 200V$ and $V_F < 6.5V$ for $V_{BR} > 201V$.

Surface Mount Transient Voltage Suppressors (TVS)

P4SMA Series 6.8 To 600 V 400W

Electrical Characteristics (T_A=25°C unless otherwise noted)

Part Number		Marking		Reverse Stand-Off Voltage V _{RWM} (V)	Breakdown Voltage V _{BR} (V) @I _T		Test Current I _T (mA)	Maximum Clamping Voltage V _C @I _{PP} (V)	Maximum Peak Pulse Current I _{PP} (A)	Maximum Reverse Leakage I _R @V _{RWM} (μA)
Uni	Bi	Uni	Bi		MIN	MAX				
P4SMA6.8A	P4SMA6.8CA	6V8A	6V8C	5.8	6.46	7.14	10	10.5	38.10	1000
P4SMA7.5A	P4SMA7.5CA	7V5A	7V5C	6.4	7.13	7.88	10	11.3	35.40	500
P4SMA8.2A	P4SMA8.2CA	8V2A	8V2C	7.0	7.79	8.61	10	12.1	33.06	200
P4SMA9.1A	P4SMA9.1CA	9V1A	9V1C	7.8	8.65	9.56	1	13.4	29.85	50
P4SMA10A	P4SMA10CA	10A	10C	8.6	9.50	10.50	1	14.5	27.59	10
P4SMA11A	P4SMA11CA	11A	11C	9.4	10.45	11.55	1	15.6	25.64	5
P4SMA12A	P4SMA12CA	12A	12C	10.2	11.40	12.60	1	16.7	23.95	5
P4SMA13A	P4SMA13CA	13A	13C	11.1	12.35	13.65	1	18.2	21.98	5
P4SMA15A	P4SMA15CA	15A	15C	12.8	14.25	15.75	1	21.2	18.87	5
P4SMA16A	P4SMA16CA	16A	16C	13.6	15.20	16.80	1	22.5	17.78	5
P4SMA18A	P4SMA18CA	18A	18C	15.3	17.10	18.90	1	25.2	15.87	5
P4SMA20A	P4SMA20CA	20A	20C	17.1	19.00	21.00	1	27.7	14.44	5
P4SMA22A	P4SMA22CA	22A	22C	18.8	20.90	23.10	1	30.6	13.07	5
P4SMA24A	P4SMA24CA	24A	24C	20.5	22.80	25.20	1	33.2	12.05	5
P4SMA27A	P4SMA27CA	27A	27C	23.1	25.65	28.35	1	37.5	10.67	5
P4SMA30A	P4SMA30CA	30A	30C	25.6	28.50	31.50	1	41.4	9.66	5
P4SMA33A	P4SMA33CA	33A	33C	28.2	31.35	34.65	1	45.7	8.75	5
P4SMA36A	P4SMA36CA	36A	36C	30.8	34.20	37.80	1	49.9	8.02	5
P4SMA39A	P4SMA39CA	39A	39C	33.3	37.05	40.95	1	53.9	7.42	5
P4SMA43A	P4SMA43CA	43A	43C	36.8	40.85	45.15	1	59.3	6.75	5
P4SMA47A	P4SMA47CA	47A	47C	40.2	44.65	49.35	1	64.8	6.17	5
P4SMA51A	P4SMA51CA	51A	51C	43.6	48.45	53.55	1	70.1	5.71	5
P4SMA56A	P4SMA56CA	56A	56C	47.8	53.20	58.80	1	77.0	5.19	5
P4SMA62A	P4SMA62CA	62A	62C	53.0	58.90	65.10	1	85.0	4.71	5
P4SMA68A	P4SMA68CA	68A	68C	58.1	64.60	71.40	1	92.0	4.35	5
P4SMA75A	P4SMA75CA	75A	75C	64.1	71.25	78.75	1	103.0	3.88	5
P4SMA82A	P4SMA82CA	82A	82C	70.1	77.90	86.10	1	113.0	3.54	5
P4SMA91A	P4SMA91CA	91A	91C	77.8	86.45	95.55	1	125.0	3.20	5
P4SMA100A	P4SMA100CA	100A	100C	85.5	95.00	105.00	1	137.0	2.92	5
P4SMA110A	P4SMA110CA	110A	110C	94.0	104.50	115.50	1	152.0	2.63	5
P4SMA120A	P4SMA120CA	120A	120C	102.0	114.00	126.00	1	165.0	2.42	5
P4SMA130A	P4SMA130CA	130A	130C	111.0	123.50	136.50	1	179.0	2.23	5
P4SMA150A	P4SMA150CA	150A	150C	128.0	142.50	157.50	1	207.0	1.93	5
P4SMA160A	P4SMA160CA	160A	160C	136.0	152.00	168.00	1	219.0	1.83	5
P4SMA170A	P4SMA170CA	170A	170C	145.0	161.50	178.50	1	234.0	1.71	5
P4SMA180A	P4SMA180CA	180A	180C	154.0	171.00	189.00	1	246.0	1.63	5
P4SMA200A	P4SMA200CA	200A	200C	171.0	190.00	210.00	1	274.0	1.46	5
P4SMA220A	P4SMA220CA	220A	220C	185.0	209.00	231.00	1	328.0	1.22	5
P4SMA250A	P4SMA250CA	250A	250C	214.0	237.50	262.50	1	344.0	1.16	5
P4SMA300A	P4SMA300CA	300A	300C	256.0	285.00	315.00	1	414.0	0.97	5
P4SMA350A	P4SMA350CA	350A	350C	299.3	332.50	367.50	1	482.0	0.83	5
P4SMA380A	P4SMA380CA	380A	380C	324.9	361.00	399.00	1	524.4	0.76	5
P4SMA400A	P4SMA400CA	400A	400C	342.0	380.00	420.00	1	552.0	0.72	5
P4SMA440A	P4SMA440CA	440A	440C	376.2	418.00	462.00	1	607.2	0.66	5
P4SMA500A	P4SMA500CA	500A	500C	427.5	475.00	525.00	1	690.0	0.58	5
P4SMA520A	P4SMA520CA	520A	520C	444.6	494.00	546.00	1	717.6	0.56	5
P4SMA550A	P4SMA550CA	550A	550C	470.3	522.50	577.50	1	759.0	0.53	5
P4SMA600A	P4SMA600CA	600A	600C	513.0	570.00	630.00	1	828.0	0.48	5

Note:

1. Suffix 'A' denotes 5% tolerance device. Without 'A' denotes 10% tolerance device
2. Add suffix 'C' or 'CA' after part number to specify Bi-directional devices
3. For Bi-Directional devices having V_R of 10 volts and under, the I_R limit is double

Surface Mount Transient Voltage Suppressors (TVS)

P4SMA Series 6.8 To 600 V 400W

Ratings and Characteristic Curves ($T_A=25^\circ\text{C}$ unless otherwise noted)

Figure 1 - Peak Pulse Power Rating Curve

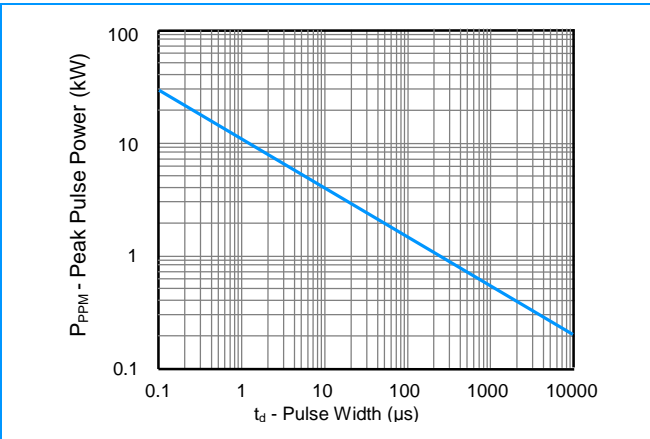

Figure 2 - Pulse Derating Curve

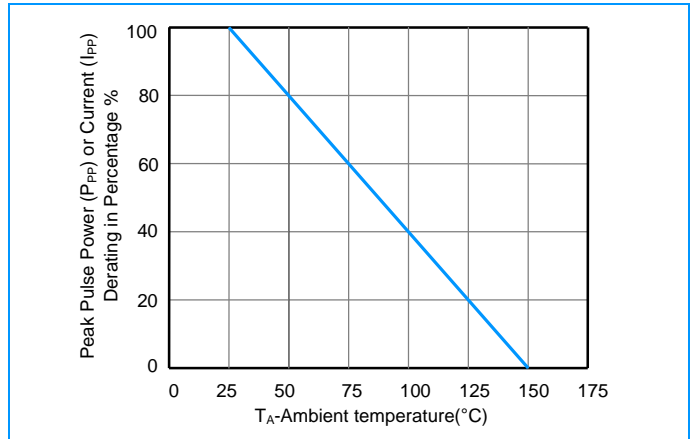

Figure 3 - Pulse Waveform

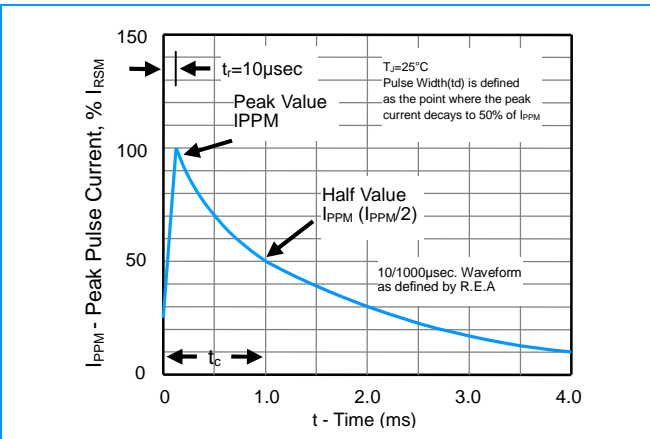

Figure 4 - Typical Junction Capacitance

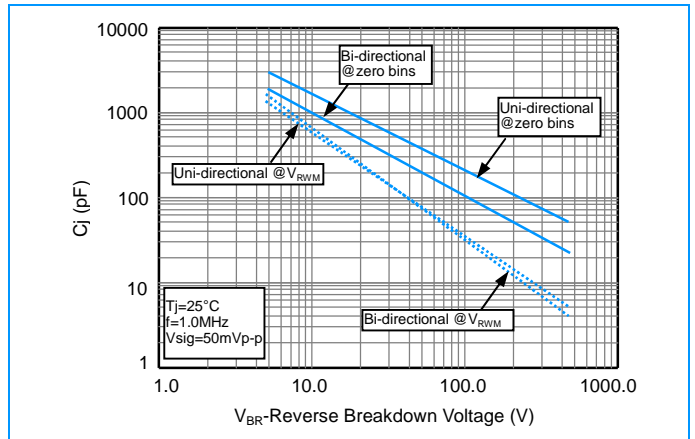

Figure 5 - Steady State Power Derating Curve

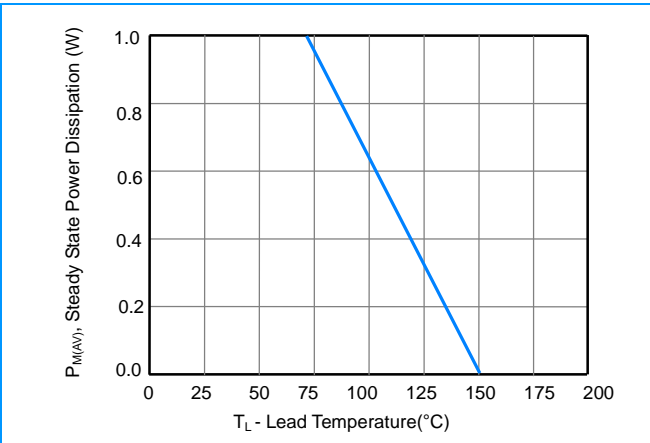
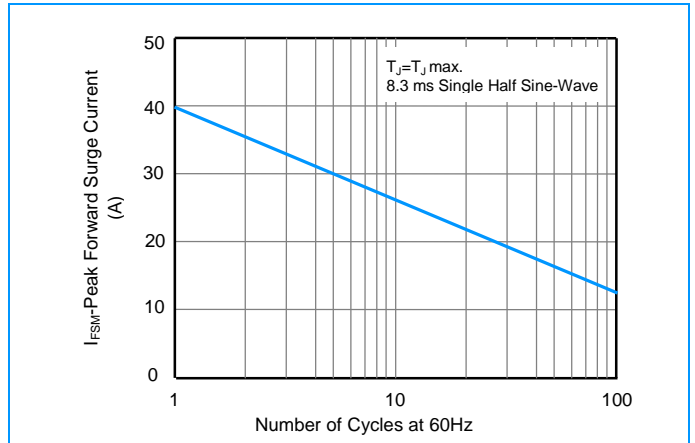

Figure 6 - Maximum Non-Repetitive Surge Current



Surface Mount Transient Voltage Suppressors (TVS)

P4SMA Series 6.8 To 600 V 400W

I-V Curve Characteristics

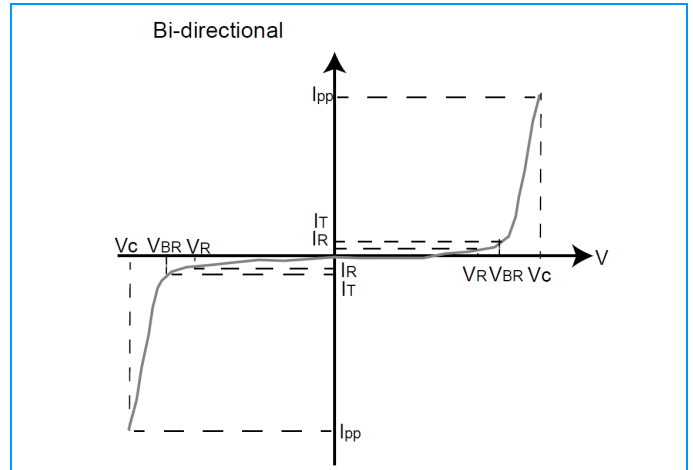
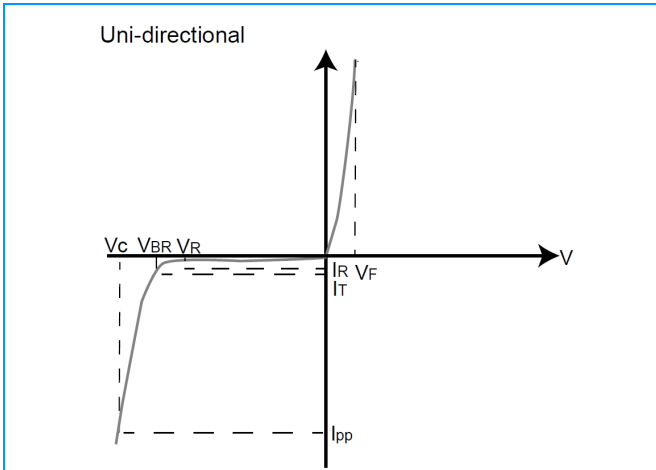

Physical Specifications

Weight	0.002 ounce, 0.061 gram
Case	JEDEC DO-214AC Molded Plastic over glass passivated junction
Polarity	Color band denotes cathode except Bipolar
Terminal	Matte Tin-plated leads, Solderable per JESD22-B102D

Environmental Specifications

Temperature Cycle	JESD22-A104
Pressure Cooker	JESD22-A102
High Temp. Storage	JESD22-A103
HTRB	JESD22-A108
Thermal Shock	JESD22-A106

Soldering Parameters

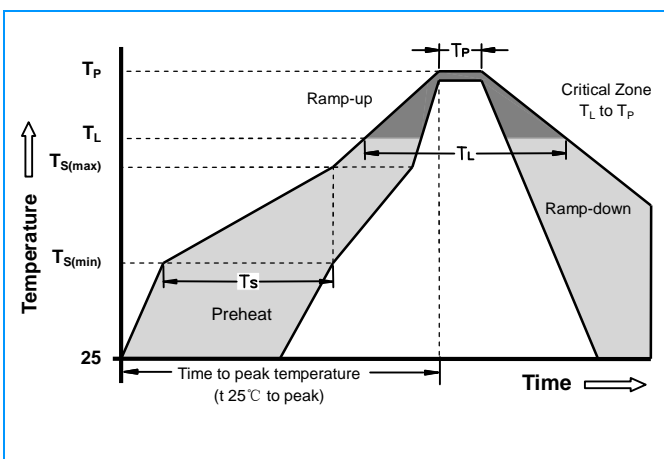

Reflow Condition		Lead-free assembly
Pre Heat	- Temperature Min ($T_{s(min)}$)	150°C
	- Temperature Max ($T_{s(max)}$)	200°C
	- Time (min to max) (t_s)	60 - 180 Seconds
Average ramp up rate (Liquidus Temp T_L) to peak		3°C/second max
$T_{s(max)}$ to T_L - Ramp-up Rate		3°C/second max
Reflow	- Temperature (T_L) (Liquidus)	217°C
	- Time (min to max) (t_s)	60 - 150 Seconds
Peak Temperature (T_P)		260 +0/-5°C
Time within 5°C of actual peak Temperature (t_p)		20 - 40 Seconds
Ramp-down Rate		6°C/second max
Time 25°C to peak Temperature (T_P)		8 minutes Max
Do not exceed		280°C

Surface Mount Transient Voltage Suppressors (TVS)

P4SMA Series 6.8 To 600 V 400W

Dimensions

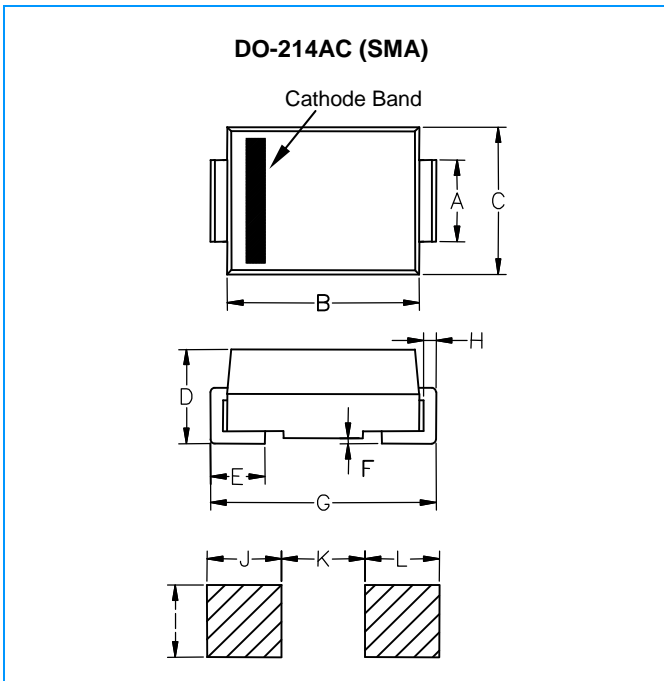

Dimensions	Inches		Millimeters	
	Min	Max	Min	Max
A	0.049	0.064	1.230	1.630
B	0.162	0.179	4.10	4.550
C	0.099	0.109	2.510	2.760
D	0.077	0.089	1.960	2.260
E	0.030	0.060	0.750	1.510
F	-	0.008	-	0.203
G	0.192	0.206	4.87	5.220
H	0.006	0.012	0.152	0.305
I	0.070	-	1.800	-
J	0.082	-	2.100	-
K	-	0.090	-	2.300
L	0.082	-	2.100	-

Part Numbering

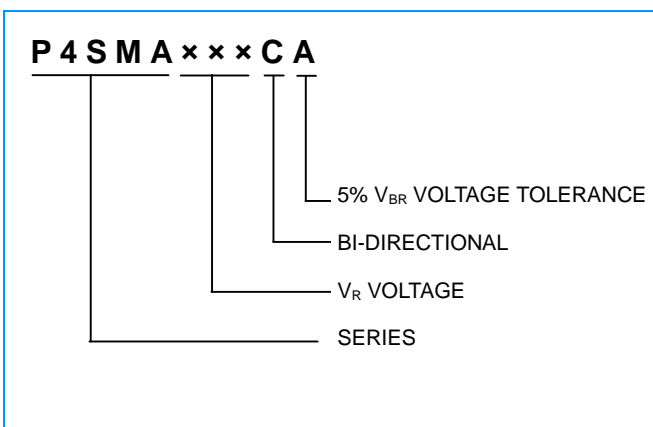

Part Marking

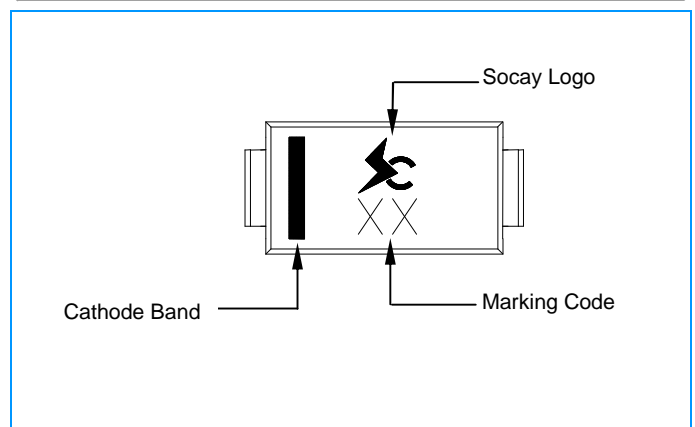

Surface Mount Transient Voltage Suppressors (TVS)

P4SMA Series 6.8 To 600 V 400W

Packaging

Part Number	Component Package	Quantity	Packaging Option	Packaging Specification
P4SMAXXXXX	DO-214AC	1000	Tape & Reel -12mm/7"tape	EIA STD RS-481

Tape and Reel Specifications

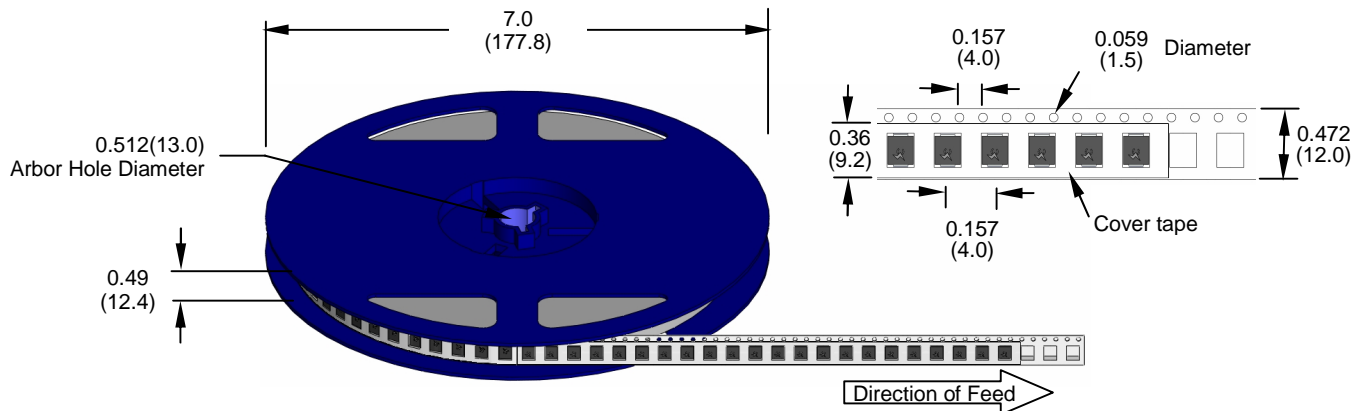

Dimensions are in inches
(and millimeters)