

SMT Current Sense Transformers

PA1005.XXXNL Series



Height: 5.5mm Max
Footprint: 8.4mm x 7.2mm Max
Current Rating: up to 20A
Frequency Range: 50kHz to 1MHz
Low Primary DCR version of P820X

Electrical Specifications @ 25°C — Operating Temperature -40°C to +130°C

Part ^{5,6} Number	Turns Ratio	Current ² Rating (A)	Secondary Inductance (mH MIN)	DCR (mΩ MAX)		Hipot (V _{RMS})
				Primary (8-7)	Secondary (1-3)	
PA1005.020NL	1:20	20	0.08	0.75	550	1000
PA1005.030NL	1:30	20	0.18	0.75	870	1000
PA1005.040NL	1:40	20	0.32	0.75	1140	1000
PA1005.050NL	1:50	20	0.50	0.75	1500	1000
PA1005.060NL	1:60	20	0.72	0.75	2250	1000
PA1005.070NL	1:70	20	0.98	0.75	4750	1000
PA1005.100NL	1:100	20	2.00	0.75	5500	1000
PA1005.125NL	1:125	20	3.00	0.75	6500	500

NOTES:

1. The temperature of component (ambient temperature plus temperature rise) must be within the specified operating temperature range.
2. The maximum current rating is based upon temperature rise of the component and represents the DC current which will cause a typical temperature rise of 40°C with no airflow when both one turn windings connected in parallel.
3. To calculate value of terminating resistor (Rt) use the following formula:
 $R_t (\Omega) = V_{REF} * N / (I_{peak_primary})$
4. The peak flux density of the device must remain below 2000 Gauss. To calculate the peak flux density for uni-polar current use following formula:

$$B_{pk} = 37.59 * V_{REF} * (Duty_Cycle_Max) * 10^5 / (N * Freq_kHz)$$

* for bi-polar current applications divide Bpk (as calculated above) by 2.

5. Optional Tape & Reel packaging can be ordered by adding a "T" suffix to the part number (i.e. PA1005.020NL becomes PA1005.020NLT). Pulse complies to industry standard tape and reel specification EIA481.
6. The "NL" suffix indicates an RoHS-compliant part number. Non-NL suffixed parts are not necessarily RoHS compliant, but are electrically and mechanically equivalent to NL versions. If a part number does not have the "NL" suffix, but an RoHS compliant version is required, please contact Pulse for availability.

Mechanical

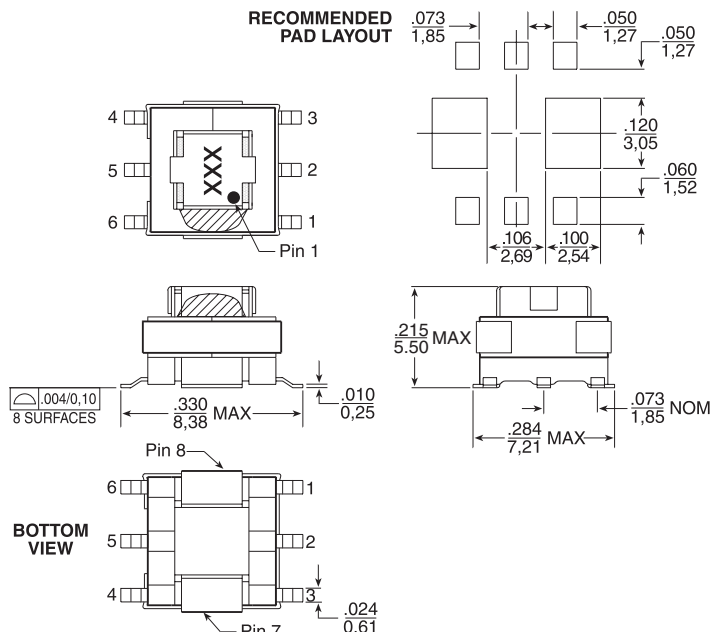

Schematic

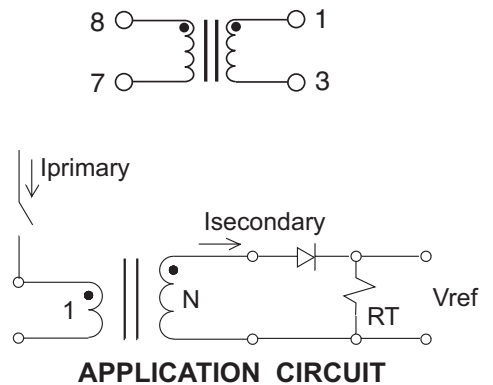

Weight 0.34 grams
 Tray 120/tray
 Tape & Reel 900/reel
 Coplanarity 0.004 inches

Dimensions: $\frac{\text{Inches}}{\text{mm}}$
 Unless otherwise specified, all tolerances are $\pm \frac{.010}{.25}$