

Power Operational Amplifiers

FEATURES

- ◆ HIGH POWER BANDWIDTH — 350kHz
- ◆ HIGH SLEW RATE — 20V/μs
- ◆ FAST SETTLING TIME — 600ns
- ◆ LOW CROSSOVER DISTORTION — Class A/B
- ◆ LOW INTERNAL LOSSES — 1.2V at 2A
- ◆ HIGH OUTPUT CURRENT — ±5A PEAK
- ◆ LOW INPUT BIAS CURRENT — FET Input
- ◆ ISOLATED CASE — 300 VDC

APPLICATIONS

- ◆ MOTOR, VALVE AND ACTUATOR CONTROL
- ◆ MAGNETIC DEFLECTION CIRCUITS UP TO 5A
- ◆ POWER TRANSDUCERS UP TO 350 kHz
- ◆ AUDIO AMPLIFIERS UP TO 44W RMS

DESCRIPTION

The PA16 and PA16A are wideband, high output current operational amplifiers designed to drive resistive, inductive and capacitive loads. Their complementary “collector output” stage can swing close to the supply rails and is protected against inductive kickback. For optimum linearity, the output stage is biased for class A/B operation. The safe operating area (SOA) can be observed for all operating conditions by selection of user programmable, current limiting resistors (down to 10mA). Both amplifiers are internally compensated but are not recommended for use as unity gain followers. For continuous operation under load, mounting on a heatsink of proper rating is recommended.

These hybrid integrated circuits utilize thick film (cermet) resistors, ceramic capacitors and semiconductor chips to maximize reliability, minimize size and give top performance. Ultrasonically bonded aluminum wires provide reliable interconnections at all operating temperatures. The Power SIP package is electrically isolated.

EQUIVALENT SCHEMATIC

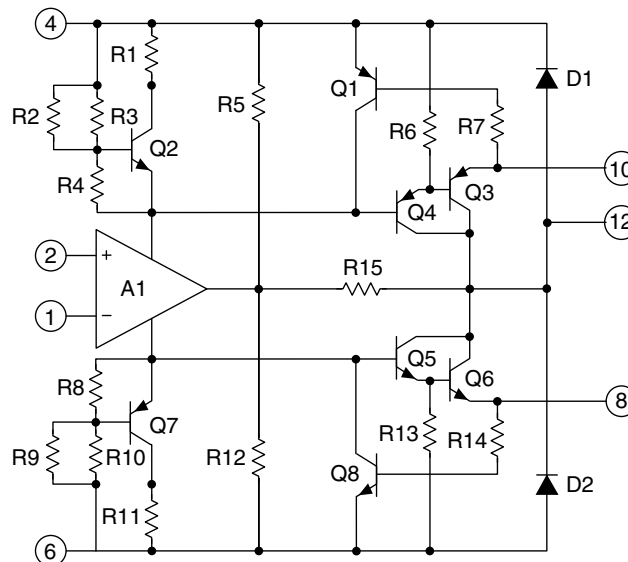

EXTERNAL CONNECTIONS

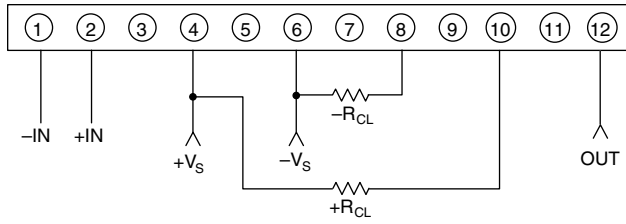

**12-pin SIP
PACKAGE
STYLE DP**
Formed leads available
See package style EE

1. CHARACTERISTICS AND SPECIFICATIONS

ABSOLUTE MAXIMUM RATINGS – PA16/PA16A

Parameter	Symbol	Min	Max	Units
SUPPLY VOLTAGE, +V _s to -V _s			38	V
OUTPUT CURRENT, within SOA			5	A
POWER DISSIPATION, internal (Note 2)			62.5	W
INPUT VOLTAGE, differential		-30	30	V
INPUT VOLTAGE, common mode		-V _s + 2	+V _s - 2	V
TEMPERATURE, pin solder, 10s max.			260	°C
TEMPERATURE, junction (Note 2)			150	°C
TEMPERATURE RANGE, storage		-40	85	°C
OPERATING TEMPERATURE RANGE, case		-25	85	°C

CAUTION The exposed substrate contains beryllia (BeO). Do not crush, machine, or subject to temperatures in excess of 850°C to avoid generating toxic fumes.

SPECIFICATIONS

Parameter	Test Condi- tions ^{3,7}	PA16			PA16A			Units
		Min	Typ	Max	Min	Typ	Max	
INPUT								
OFFSET VOLTAGE, initial			±5	±10		±1	±3	mV
OFFSET VOLTAGE vs. temp	Full temp range		±10	±50		*	±25	µV/°C
OFFSET VOLTAGE vs. supply			±10			*		µV/V
OFFSET VOLTAGE vs. power			±6			*		µV/W
BIAS CURRENT, initial			50	200		25	100	pA
BIAS CURRENT, vs. temp				200			*	pA/°C
BIAS CURRENT, vs. supply			0.01			*		pA/V
OFFSET CURRENT, initial			25	100		15	50	pA
OFFSET CURRENT, vs. temp				100			*	pA/°C
INPUT IMPEDANCE, DC			1000			*		GΩ
INPUT CAPACITANCE			3			*		pF

Parameter	Test Conditions ^{3,7}	PA16			PA16A			Units
		Min	Typ	Max	Min	Typ	Max	
COMMON MODE VOLTAGE RANGE, Pos. (Note 6)	Full temp range	+V _S - 6	+V _S - 3		*	*		V
COMMON MODE VOLTAGE RANGE, Neg. (Note 6)	Full temp range	-V _S + 6	-V _S + 5		*	*		V
COMMON MODE REJECTION, DC	Full temp range	70	100		*	*		dB
GAIN								
OPEN LOOP GAIN @ 10Hz	1KΩ load		103			*		dB
OPEN LOOP GAIN @ 10Hz	Full temp range, 10KΩ load	86	100		*	*		dB
GAIN BANDWIDTH PRODUCT @ 1MHz	10Ω load		4.5			*		MHz
POWER BANDWIDTH	10Ω load		350			*		kHz
PHASE MARGIN	Full temp range, 10Ω load		30			*		°
OUTPUT								
VOLTAGE SWING (Note 4)	I _O = 5A, R _{CL} = 0.08Ω	±V _S - 4	±V _S - 3		±V _S - 3	*		V
VOLTAGE SWING (Note 4)	I _O = 2A	±V _S - 2	±V _S - 1.2		±V _S - 1.2	*		V
CURRENT, peak		5			*			A
SETTLING TIME to 0.1%	2V step		0.6			*		μS
SLEW RATE		13	20		*	*		V/μS
CAPACITIVE LOAD	Full temp range, A _V > 10		SOA			*		
HARMONIC DISTORTION	P _O = 5W, F = 1kHz, R _L = 4Ω		0.028			*		%
SMALL SIGNAL rise/fall time	R _L = 10Ω, A _V = 1		100			*		nS
SMALL SIGNAL overshoot	R _L = 10Ω, A _V = 1		10			*		%
POWER SUPPLY								
VOLTAGE	Full temp range	±7	±15	±19	*	*	*	V
CURRENT, quiescent			27	40		*	*	mA
THERMAL								
RESISTANCE, AC, junction to case (Note 5)	F > 60Hz		1.4	1.63		*	*	°C/W
RESISTANCE, DC, junction to case	F < 60Hz		1.8	2.0		*	*	°C/W
RESISTANCE, DC, junction to air			30			*		°C/W
TEMPERATURE RANGE, case	Meets full range specification	-25		+85	*		*	°C

NOTES:

1. (All Min/Max characteristics and specifications are guaranteed over the Specified Operating Conditions. Typical performance characteristics and specifications are derived from measurements taken at typical supply voltages and $T_C = 25^\circ\text{C}$).
2. Long term operation at the maximum junction temperature will result in reduced product life. Derate power dissipation to achieve high MTTF.
- * The specification of PA16A is identical to the specification for PA16 in applicable column to the left.
3. The power supply voltage for all specifications is the TYP rating unless otherwise noted as a test condition.
4. $+V_S$ and $-V_S$ denote the positive and negative supply rail respectively. Total V_S is measured from $+V_S$ to $-V_S$.
5. Rating applies if the output current alternates between both output transistors at a rate faster than 60Hz.
6. Exceeding CMV range can cause the output to latch.
7. Full temperature specifications are guaranteed but not 100% tested.
8. The absolute maximum negative input voltage is equal to the negative power supply voltage plus 1V ($-V_S + 1V$).

TYPICAL APPLICATION

Vehicular Sound System Power Stage

When system voltages are low and power is at a premium, the PA16 is a natural choice. The circuit above utilizes not only the feature of low internal loss of the PA16, but also its very low distortion level to implement a crystal clear audio amplifier suitable even for airborne applications. This circuit uses AC coupling of both the input signal and the gain circuit to render DC voltage across the speaker insignificant. The resistor and capacitor across the inputs form a stability enhancement network. The 0.27 ohm current limit resistors provide protection in the event of an output short circuit.

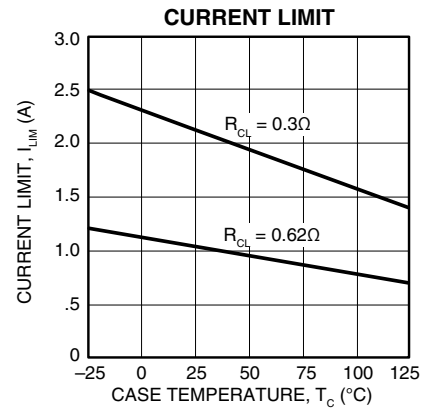
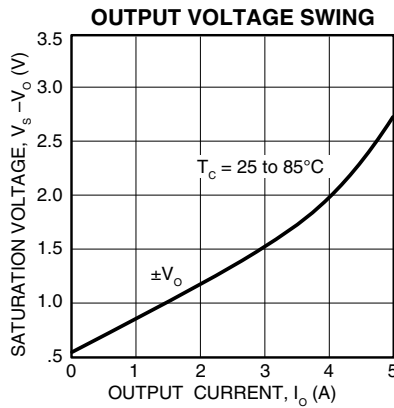
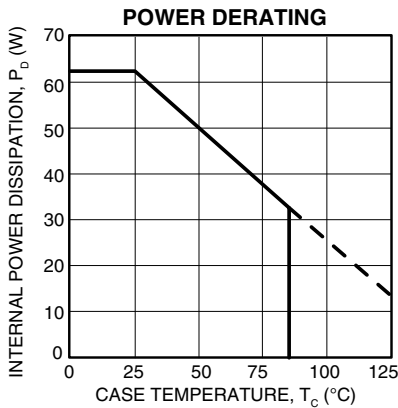
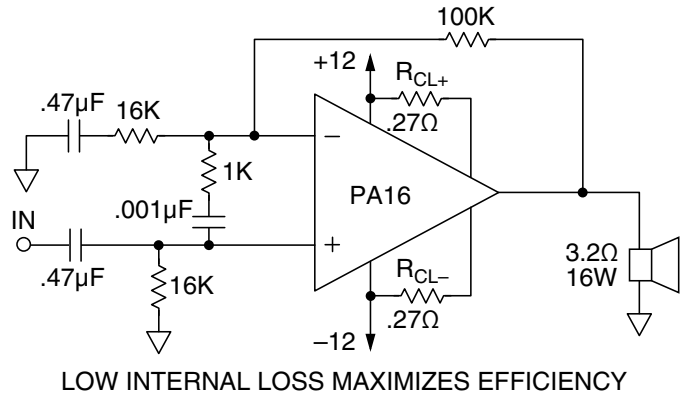

SMALL SIGNAL RESPONSE

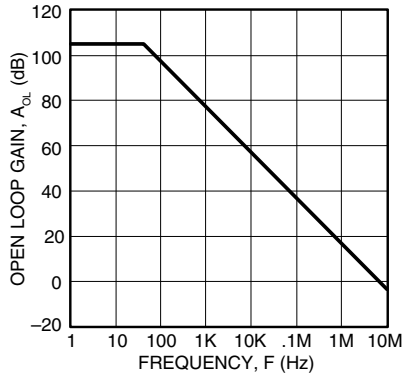

PHASE RESPONSE

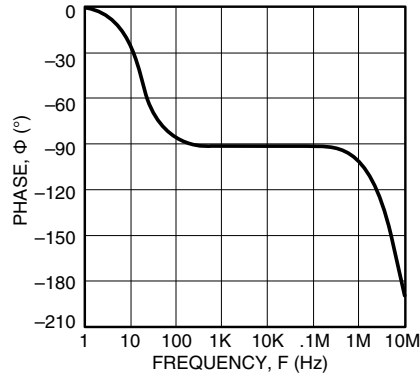

POWER RESPONSE

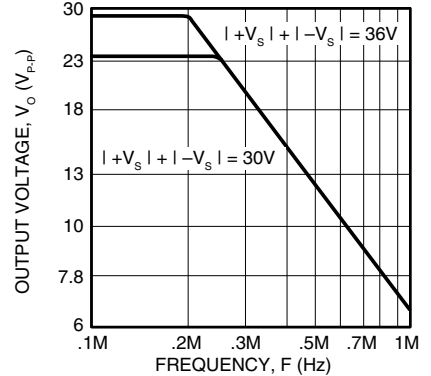

BIAS CURRENT

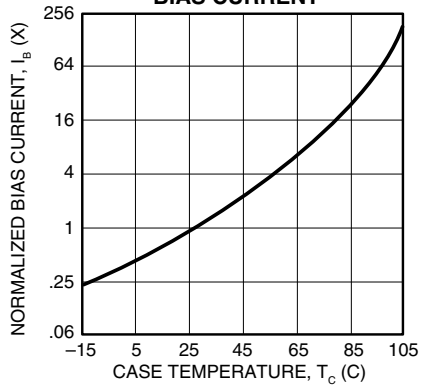

COMMON MODE REJECTION

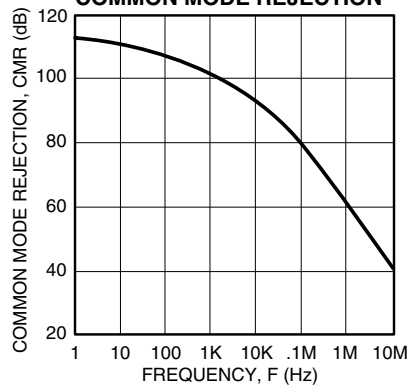

POWER SUPPLY REJECTION

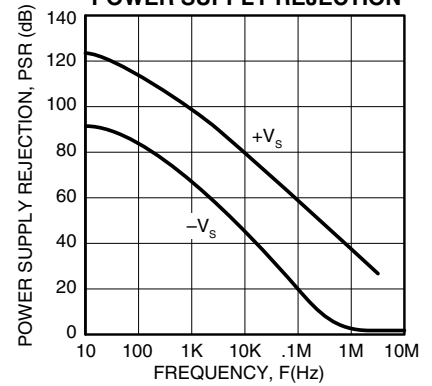

INPUT NOISE

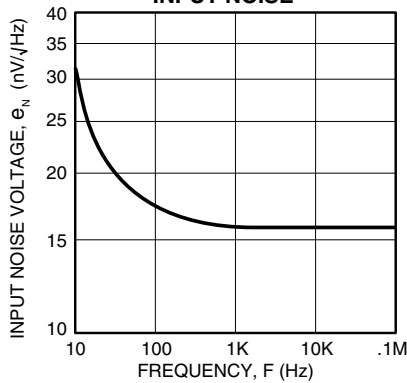

SETTLING TIME

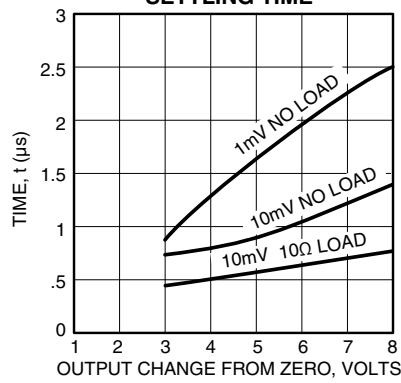

QUIESCENT CURRENT

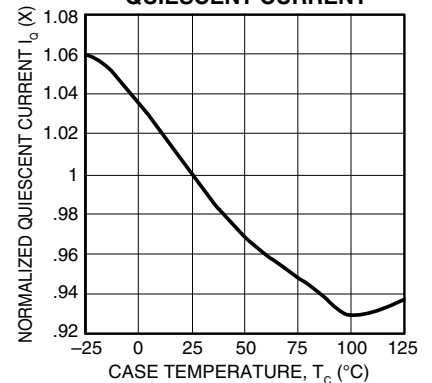

HARMONIC DISTORTION

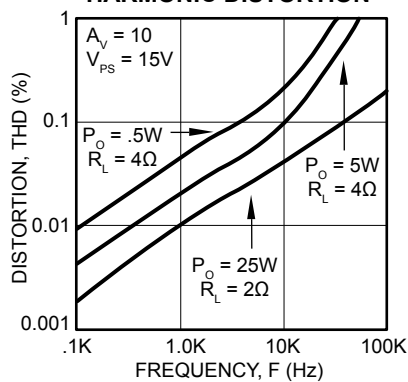

PULSE RESPONSE

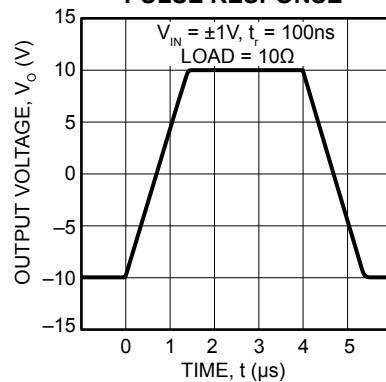

PULSE RESPONSE

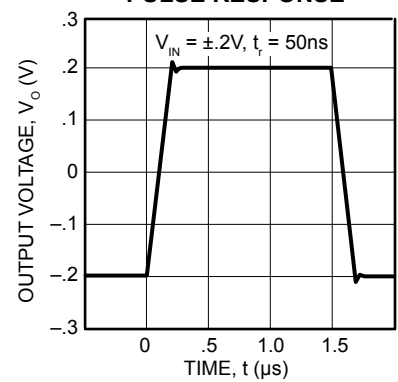

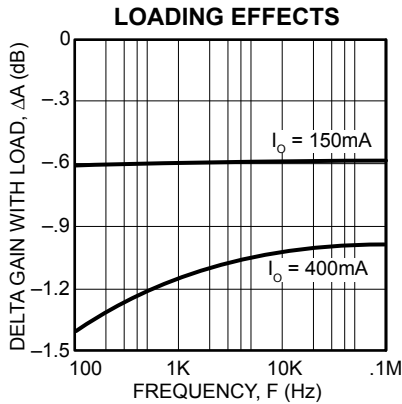

GENERAL

Please read Application Note 1 "General Operating Considerations" which covers stability, supplies, heat sinking, mounting, current limit, SOA interpretation, and specification interpretation. Visit www.cirrus.com for design tools that help automate tasks such as calculations for stability, internal power dissipation, current limit; heat sink selection; Apex’s complete Application Notes library; Technical Seminar Workbook; and Evaluation Kits.

SAFE OPERATING AREA (SOA)

The SOA curves combine the effect of all limits for this Power Op Amp. For a given application, the direction and magnitude of the output current should be calculated or measured and checked against the SOA curves. This is simple for resistive loads but more complex for reactive and EMF generating loads. The following guidelines may save extensive analytical efforts:

The amplifier can handle any EMF generating or reactive load and short circuits to the supply rails or shorts to common if the current limits are set as follows at $T_c = 85^\circ\text{C}$.

$\pm V_s$	SHORT TO $\pm V_s$ C, L OR EMF LOAD	SHORT TO COMMON
18V	.9A	1.8A
15V	1.0A	2.1A
10V	1.6A	3.2A

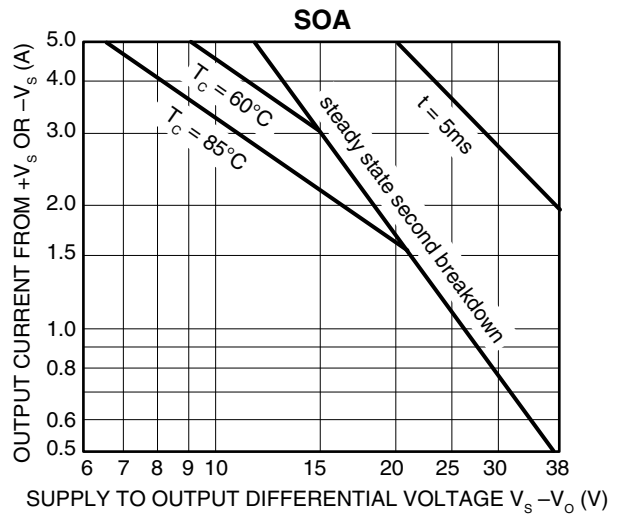

These simplified limits may be exceeded with further analysis using the operating conditions for a specific application.

CURRENT LIMIT

Proper operation requires the use of two current limit resistors, connected as shown in the external connection diagram. The minimum value for R_{CL} is 0.12 ohm, however for optimum reliability it should be set as high as possible. Refer to the "General Operating Considerations" section of the handbook for current limit adjust details.

$$R_{CL} = \frac{0.65}{I_{LIM} (A)} - 0.01$$

DEVICE MOUNTING

The case (mounting flange) is electrically isolated and should be mounted directly to a heatsink with thermal compound. Screws with Belleville spring washers are recommended to maintain positive clamping pressure on heatsink mounting surfaces. Long periods of thermal cycling can loosen mounting screws and increase thermal resistance. Since the case is electrically isolated (floating) with respect to the internal circuits it is recommended to connect it to common or other convenient AC ground potential.

CONTACTING CIRRUS LOGIC SUPPORT

For all Apex Precision Power product questions and inquiries, call toll free 800-546-2739 in North America.

For inquiries via email, please contact tucson.support@cirrus.com.

International customers can also request support by contacting their local Cirrus Logic Sales Representative.

To find the one nearest to you, go to www.cirrus.com

IMPORTANT NOTICE

Cirrus Logic, Inc. and its subsidiaries ("Cirrus") believe that the information contained in this document is accurate and reliable. However, the information is subject to change without notice and is provided "AS IS" without warranty of any kind (express or implied). Customers are advised to obtain the latest version of relevant information to verify, before placing orders, that information being relied on is current and complete. All products are sold subject to the terms and conditions of sale supplied at the time of order acknowledgment, including those pertaining to warranty, indemnification, and limitation of liability. No responsibility is assumed by Cirrus for the use of this information, including use of this information as the basis for manufacture or sale of any items, or for infringement of patents or other rights of third parties. This document is the property of Cirrus and by furnishing this information, Cirrus grants no license, express or implied under any patents, mask work rights, copyrights, trademarks, trade secrets or other intellectual property rights. Cirrus owns the copyrights associated with the information contained herein and gives consent for copies to be made of the information only for use within your organization with respect to Cirrus integrated circuits or other products of Cirrus. This consent does not extend to other copying such as copying for general distribution, advertising or promotional purposes, or for creating any work for resale.

CERTAIN APPLICATIONS USING SEMICONDUCTOR PRODUCTS MAY INVOLVE POTENTIAL RISKS OF DEATH, PERSONAL INJURY, OR SEVERE PROPERTY OR ENVIRONMENTAL DAMAGE ("CRITICAL APPLICATIONS"). CIRRUS PRODUCTS ARE NOT DESIGNED, AUTHORIZED OR WARRANTED TO BE SUITABLE FOR USE IN PRODUCTS SURGICALLY IMPLANTED INTO THE BODY, AUTOMOTIVE SAFETY OR SECURITY DEVICES, LIFE SUPPORT PRODUCTS OR OTHER CRITICAL APPLICATIONS. INCLUSION OF CIRRUS PRODUCTS IN SUCH APPLICATIONS IS UNDERSTOOD TO BE FULLY AT THE CUSTOMER'S RISK AND CIRRUS DISCLAIMS AND MAKES NO WARRANTY, EXPRESS, STATUTORY OR IMPLIED, INCLUDING THE IMPLIED WARRANTIES OF MERCHANTABILITY AND FITNESS FOR PARTICULAR PURPOSE, WITH REGARD TO ANY CIRRUS PRODUCT THAT IS USED IN SUCH A MANNER. IF THE CUSTOMER OR CUSTOMER'S CUSTOMER USES OR PERMITS THE USE OF CIRRUS PRODUCTS IN CRITICAL APPLICATIONS, CUSTOMER AGREES, BY SUCH USE, TO FULLY INDEMNIFY CIRRUS, ITS OFFICERS, DIRECTORS, EMPLOYEES, DISTRIBUTORS AND OTHER AGENTS FROM ANY AND ALL LIABILITY, INCLUDING ATTORNEYS' FEES AND COSTS, THAT MAY RESULT FROM OR ARISE IN CONNECTION WITH THESE USES.

Cirrus Logic, Cirrus, and the Cirrus Logic logo designs, Apex Precision Power, Apex and the Apex Precision Power logo designs are trademarks of Cirrus Logic, Inc. All other brand and product names in this document may be trademarks or service marks of their respective owners.