

PC401

Compact, Surface Mount Type OPIC Photocoupler

■ Features

1. Mini-flat package
2. "High" output during light emission
3. Isolation voltage between input and output
($V_{iso} : 3\,750V_{rms}$)
4. TTL and LSTTL compatible output
5. Recognized by UL(No.64380)

■ Applications

1. Hybrid substrate which requires high density mounting
2. Personal computers, office computers and peripheral equipment
3. Electronic musical instruments

■ Package Specifications

Model No.	Package specifications	Diameter of reel	Tape width
PC401	Taping package (Net : 3 000pcs.)	370mm	12mm
PC401T	Taping package (Net : 750pcs.)	178mm	12mm
PC401Z	Sleeve package (Net : 100pcs.)	-	-

■ Absolute Maximum Ratings

($T_a = 25^\circ C$)

Parameter		Symbol	Rating	Unit
Input	Forward current	I_F	50	mA
	Reverse voltage	V_R	6	V
	Power dissipation	P	70	mW
Output	Supply voltage	V_{CC}	16	V
	High level output voltage	V_{OH}	16	V
	Low level output current	I_{OL}	50	mA
	Power dissipation	P_O	130	mW
Total power dissipation		P_{tot}	150	mW
*1	Isolation voltage	V_{iso}	3 750	V_{rms}
Operating temperature		T_{opr}	- 25 to + 85	$^\circ C$
Storage temperature		T_{stg}	- 40 to + 125	$^\circ C$
*2	Soldering temperature	T_{sol}	260	$^\circ C$

*1 AC for 1 minute, 40 to 60% RH

*2 For 10 seconds

■ Outline Dimensions

(Unit : mm)

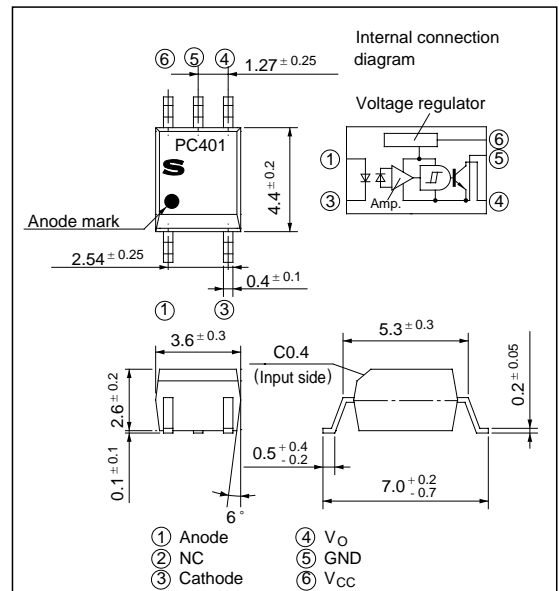

* "OPIC" (Optical IC) is a trademark of the SHARP Corporation.

An OPIC consists of a light-detecting element and signal-processing circuit integrated onto a single chip.

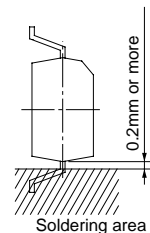

Electro-optical Characteristics

($T_a = 0$ to $+70^\circ\text{C}$ unless otherwise specified.)

Parameter		Symbol	Conditions	MIN.	TYP.	MAX.	Unit	
Input	Forward voltage	V_F	$I_F = 4\text{mA}$	-	1.1	1.4	V	
			$I_F = 0.3\text{mA}$	0.7	1.0	-		
	Reverse current	I_R	$T_a = 25^\circ\text{C}, V_R = 3\text{V}$	-	-	10	μA	
	Terminal capacitance	C_t	$T_a = 25^\circ\text{C}, V = 0, f = 1\text{kHz}$	-	30	250	pF	
Output	Operating supply voltage	V_{CC}		3	-	15	V	
	Low level output voltage	V_{OL}	$I_F = 0, V_{CC} = 5\text{V}, I_{OL} = 16\text{mA}$	-	0.2	0.4	V	
	High level output current	I_{OH}	$I_F = 4\text{mA}, V_{CC} = V_O = 15\text{V}$	-	-	100	μA	
	Low level supply current	I_{CCL}	$I_F = 0, V_{CC} = 5\text{V}$	-	2.5	5.0	mA	
	High level supply current	I_{CCH}	$I_F = 4\text{mA}, V_{CC} = 5\text{V}$	-	2.7	5.5	mA	
Transfer characteristics	*3 "H \rightarrow L" threshold input current	I_{FHL}	$T_a = 25^\circ\text{C}, V_{CC} = 5\text{V}, R_L = 280\Omega$	0.4	0.8	-	mA	
			$V_{CC} = 5\text{V}, R_L = 280\Omega$	0.3	-	-		
	*4 "L \rightarrow H" threshold input current	I_{FLH}	$T_a = 25^\circ\text{C}, V_{CC} = 5\text{V}, R_L = 280\Omega$	-	1.1	2.0	mA	
			$V_{CC} = 5\text{V}, R_L = 280\Omega$	-	-	4.0		
	*5 Hysteresis		I_{FHL} / I_{FLH}	$V_{CC} = 5\text{V}, R_L = 280\Omega$	0.5	0.7	0.9	
	Isolation resistance		R_{ISO}	$T_a = 25^\circ\text{C}, \text{DC} 500\text{V}, 40$ to 60% RH	5×10^{10}	10^{11}	-	Ω
*6 Response time	"H \rightarrow L" propagation delay time	t_{PHL}	$T_a = 25^\circ\text{C}, V_{CC} = 5\text{V}$ $R_L = 280\Omega, I_F = 4\text{mA}$	-	2	6	μs	
	"L \rightarrow H" propagation delay time	t_{PLH}		-	1	3		
	Fall time	t_f		-	0.05	0.5		
	Rise time	t_r		-	0.1	0.5		

*3 I_{FHL} represents forward current when output goes from high to low.

*4 I_{FLH} represents forward current when output goes from low to high.

*5 Hysteresis stands for I_{FHL} / I_{FLH} .

*6 Test circuit for response time is shown below.

Test Circuit for Response Time

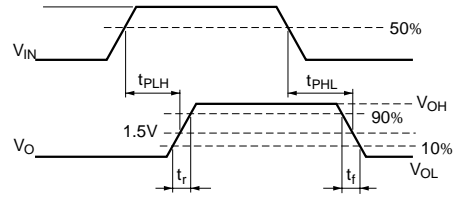
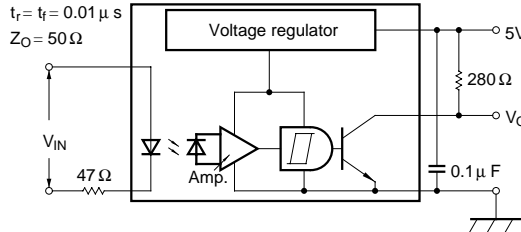

Fig. 1 Forward Current vs. Ambient Temperature

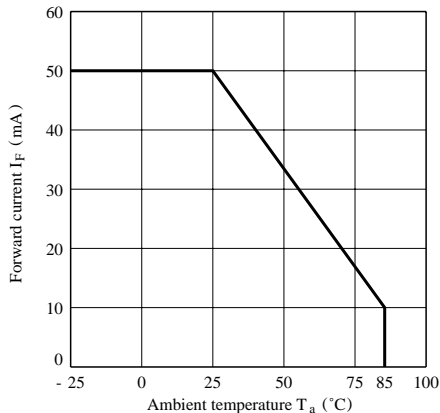

Fig. 2 Power Dissipation vs. Ambient Temperature

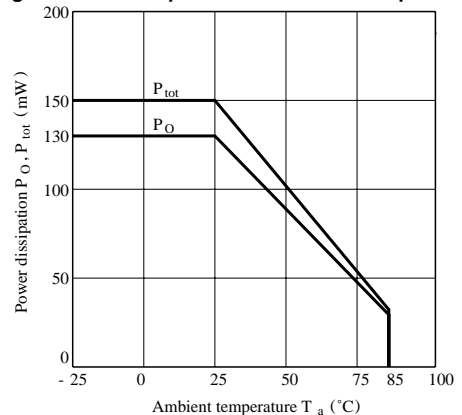

Fig. 3 Forward Current vs. Forward Voltage

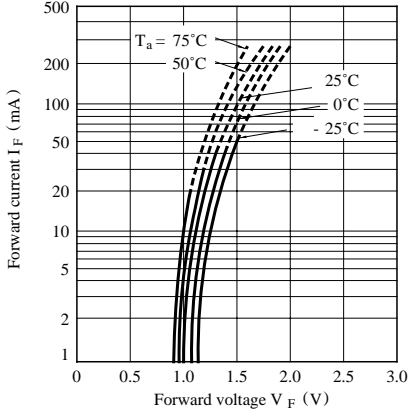

Fig. 4 Relative Threshold Input Current vs. Supply Voltage

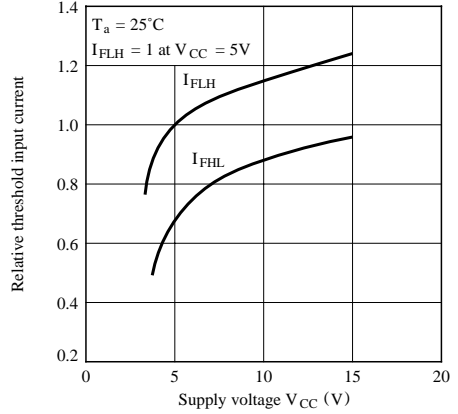

Fig. 5 Relative Threshold Input Current vs. Ambient Temperature

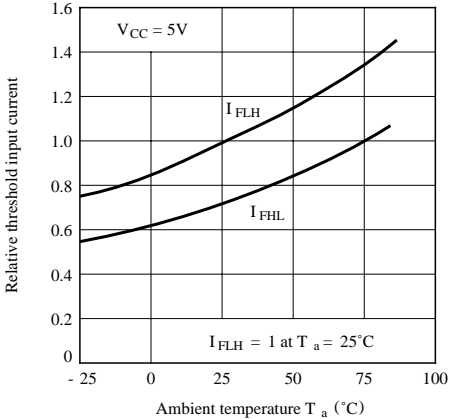

Fig. 6 Low Level Output Voltage vs. Low Level Output Current

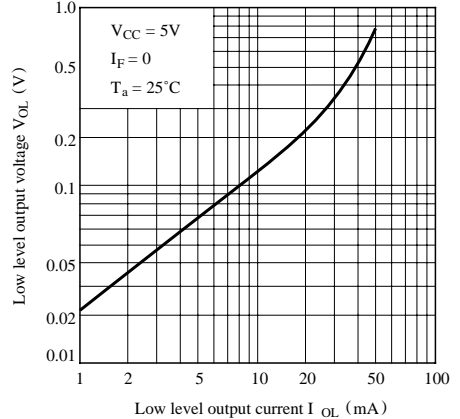

Fig. 7 Low Level Output Voltage vs. Ambient Temperature

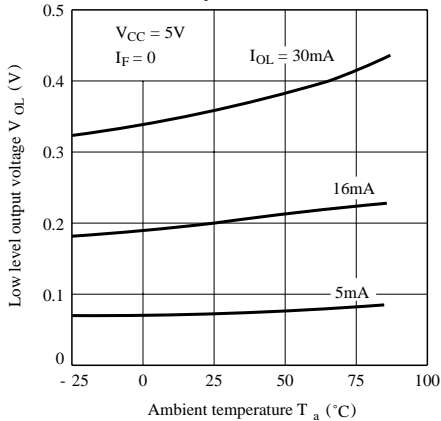

Fig. 8 High Level Output Current vs. Forward Current

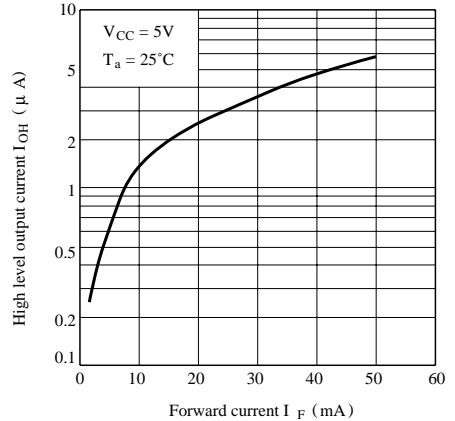

Fig. 9 High Level Output Current vs. Ambient Temperature

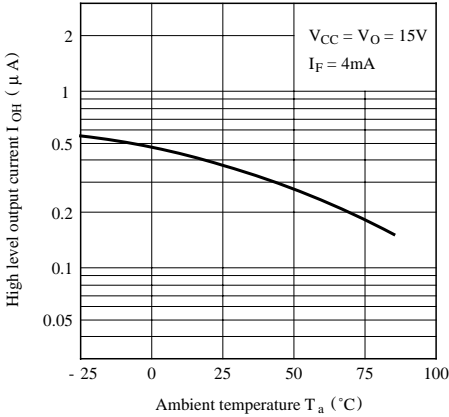

Fig.10 Supply Current vs. Supply Voltage

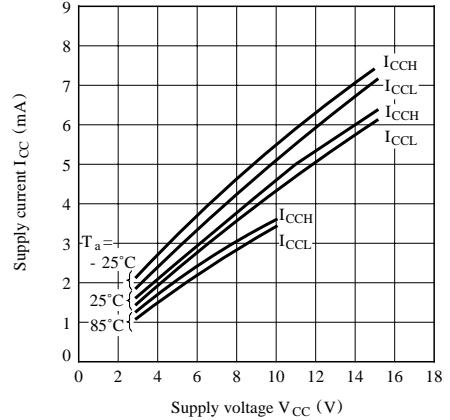

Fig.11 Propagation Delay Time vs. Forward Current

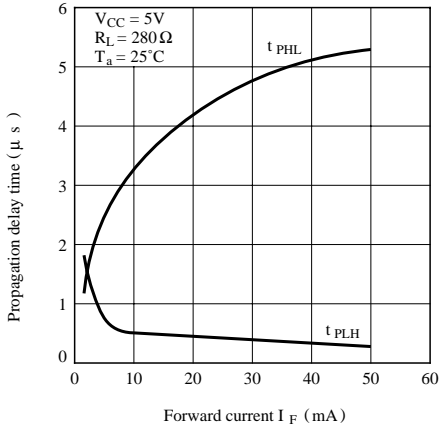
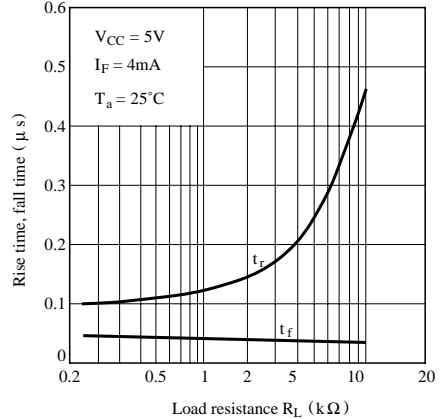

Fig.12 Rise Time, Fall Time vs. Load Resistance



■ Preautions for Use

- (1) It is recommended that a by-pass capacitor of more than 0.01μ F is added between V_{cc} and GND near the device in order to stabilize power supply line.
- (2) Handle this product the same as with other integrated circuits against static electricity.
- (3) As for other general cautions, refer to the chapter “Preautions for Use”