

Electro-optical Characteristics

(Unless otherwise specified, Ta = 0 to 70°C)

Parameter		Symbol	Conditions	MIN.	TYP.	MAX.	Unit		
Input	Forward voltage	V _F	Ta = 25°C, I _F = 10mA	-	1.6	1.9	V		
	Reverse current	I _R	Ta = 25°C, V _R = 5V	-	-	10	μA		
	Terminal capacitance	C _t	Ta = 25°C, V = 0, f = 1MHz	-	60	150	pF		
Output	High level output current	I _{OH}	V _{CC} = V _O = 5.5V, V _E = 2.0V, I _F = 250 μA	-	2	250	μA		
	Low level output voltage	V _{OL}	V _{CC} = 5.5V, V _E = 2.0V, I _F = 5mA, I _{OL} = 13mA	-	0.4	0.6	V		
	High level enable current	I _{EH}	V _{CC} = 5.5V, V _E = 2.0V	-	- 0.8	- 1.8	mA		
	Low level enable current	I _{EL}	V _{CC} = 5.5V, V _E = 0.5V	-	- 1.2	- 2.0	mA		
	High level supply current	I _{CCH}	V _{CC} = 5.5V, I _F = 0, V _E = 0.5V	-	7	15	mA		
	Low level supply current	I _{CCL}	V _{CC} = 5.5V, I _F = 10mA, V _E = 0.5V	-	13	18	mA		
	"High→Low" threshold input current	I _{FHL}	V _{CC} = 5V, V _E = 2.0V V _O = 0.8V, R _L = 350Ω	-	2.5	5	mA		
Isolation resistance	R _{iso}	Ta = 25°C, DC500V, 40 to 60% RH	5 x 10 ¹⁰	10 ¹⁰	-	Ω			
Floating capacitance	C _f	Ta = 25°C, V = 0, f = 1MHz	-	0.6	5	pF			
Transfer characteristics	Response time	"High→Low" propagation delay time	t _{PHL}	Ta = 25°C, V _{CC} = 5V R _L = 350Ω, C _L = 15pF I _F = 7.5mA	Fig. 1	-	50	120	ns
		"Low→High" propagation delay time	t _{PLH}			-	50	120	ns
		Rise time, Fall time	t _r , t _f			-	30	60	ns
	"High→Low" enable propagation delay time	t _{EH}	Ta = 25°C, V _{CC} = 5V R _L = 350Ω, C _L = 15pF I _F = 7.5mA, V _{EH} = 3V V _{EL} = 0.5V	Fig. 2	-	15	50	ns	
		"Low→High" enable propagation delay time			t _{ELH}	-	65	100	ns
CMR	Instantaneous common mode rejection voltage "Output: High level"	CM _H	Ta = 25°C, V _{CC} = 5V, V _{CM} = 10V _(peak) R _L = 350Ω, I _F = 0, V _{O(MIN)} = 2V	Fig. 3	100	500	-	V/μs	
	Instantaneous common mode rejection voltage "Output: Low level"	CM _L	Ta = 25°C, V _{CC} = 5V, V _{CM} = 10V _(peak) R _L = 350Ω, I _F = 5mA, V _{O(MAX)} = 0.8V	Fig. 3	- 100	- 500	-	V/μs	

All typical values : at Ta = 25°C, V_{CC} = 5V

Recommended Operating Conditions

Parameter	Symbol	MIN.	MAX.	Unit
Low level input current	I _{FL}	0	250	μA
High level input current	I _{FH}	7	15	mA
High level enable voltage	V _{EH}	2.0	V _{CC}	V
Low level enable voltage	V _{EL}	0	0.8	V
Supply voltage	V _{CC}	4.5	5.5	V
Fanout (TTL load)	N	-	8	-
Operating temperature	T _{opr}	0	70	°C

- When the enable input is in high level state, external pull-up resistor is unnecessary.
- Connect a by-pass ceramic capacitor (0.01 to 0.1μF) between V_{CC} and GND at the position within 1cm from pin.

Circuit Block Diagram

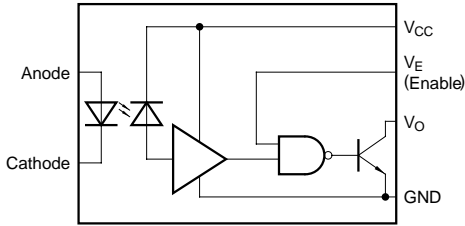

Truth Table

Input	Enable	Output
H	H	L
L	H	H
H	L	H
L	L	H

L : Logic (0)
H : Logic (1)

Fig. 1 Test Circuit for t_{PHL} , t_{PLH} , t_r and t_f

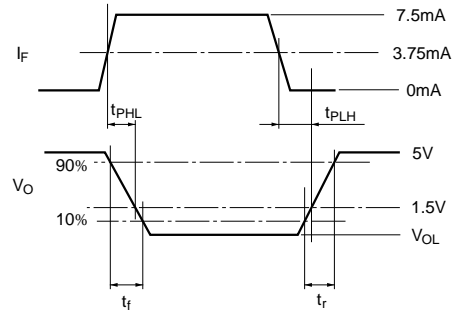
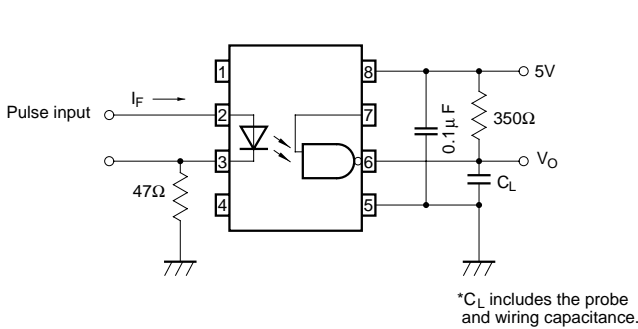

Fig. 2 Test Circuit for t_{EHL} and t_{ELH}

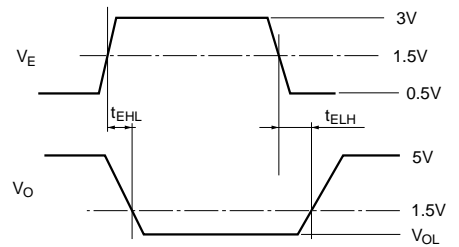
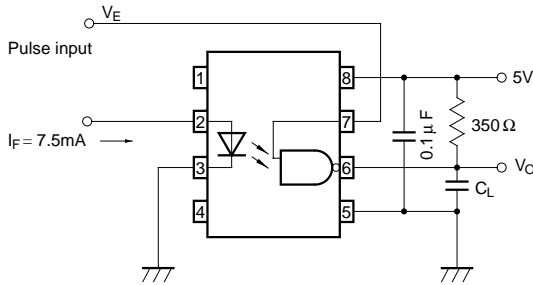

Fig. 3 Test Circuit for CM_H and CM_L

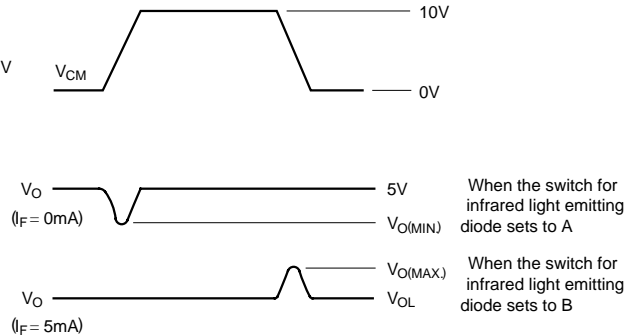
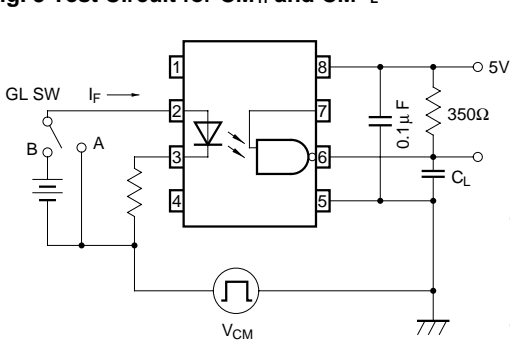

Fig. 4 Collector Power Dissipation vs. Ambient Temperature

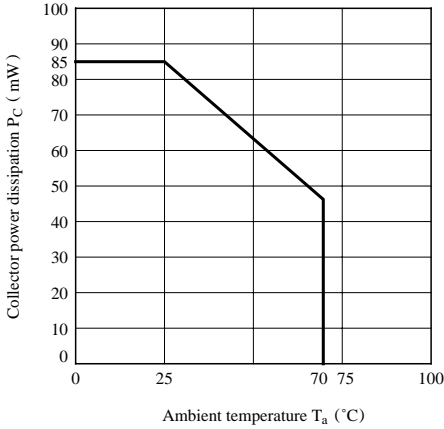

Fig. 5 Forward Current vs. Forward Voltage

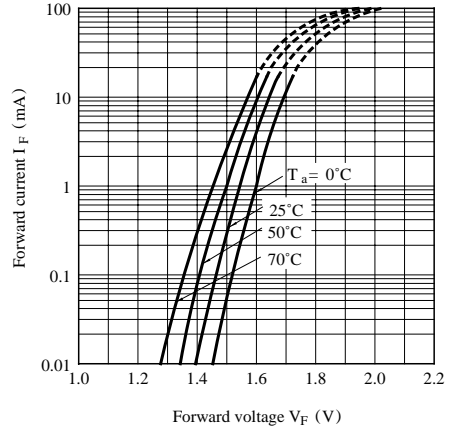

Fig. 6 High Level Output Current vs. Ambient Temperature

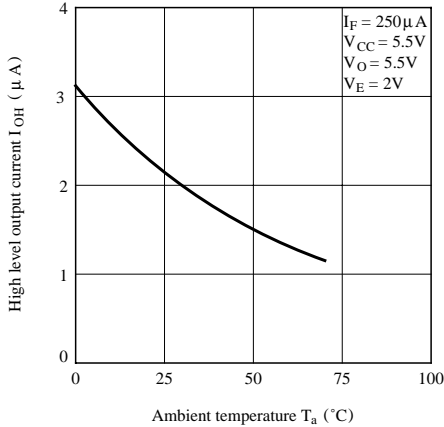

Fig. 7 Low Level Output Voltage vs. Ambient Temperature

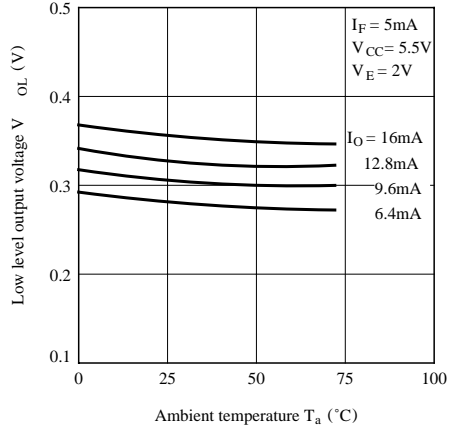

Fig. 8-a Output Voltage vs. Forward Current

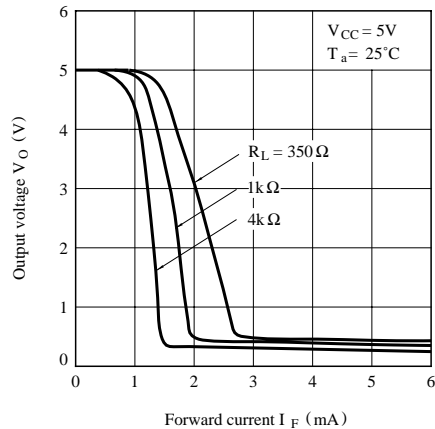

Fig. 8-b Output Voltage vs. Forward Current (Ambient Temp. Characteristics)

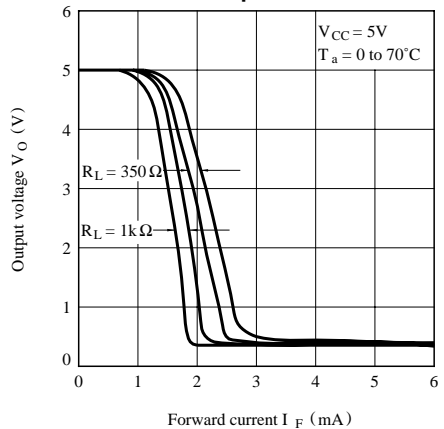

Fig. 9 Propagation Delay Time vs. Forward Current

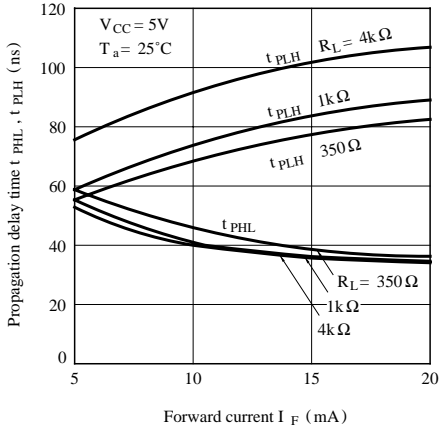

Fig.10 Propagation Delay Time vs. Ambient Temperature

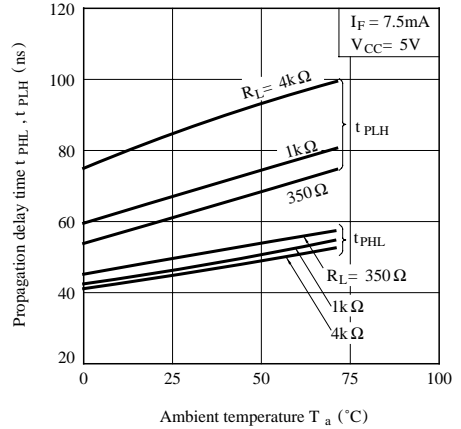

Fig.11 Rise Time, Fall Time vs. Ambient Temperature

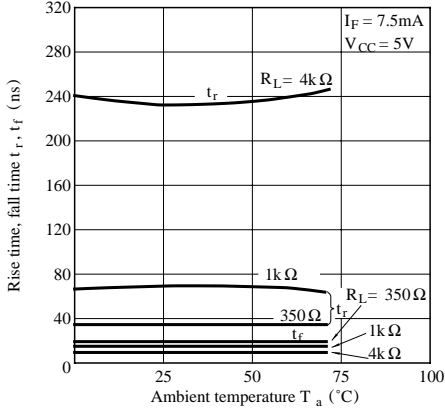
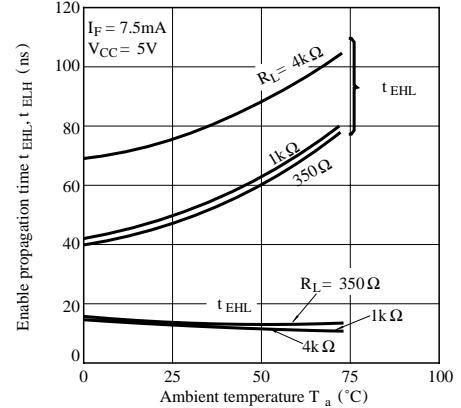

Fig.12 Enable Propagation Time vs. Ambient Temperature



■ Precautions for Use

- (1) Handle this product the same as with other integrated circuits against static electricity.
- (2) As for other general cautions, refer to the chapter “Precautions for Use”