

PC920 Power OPIC Photocoupler

T-41-83

Features

- High power
 $(I_{O1} : \text{MAX. } -0.8\text{A (DC)})$
 $(I_{O2} : \text{MAX. } 1.6\text{A (Pulse)})$
- Low input current drive
 $(I_{FLH} : \text{MAX. } 2\text{mA at } T_a = T_{opr})$
- Operating supply voltage $V_{CC} : 5.4 \sim 15\text{V}$
- Compact single-in-line package (With heat sink)
- UL recognized, file No. E64380

Applications

- Inverter controlled air conditioners

Outline Dimensions

(Unit : mm)

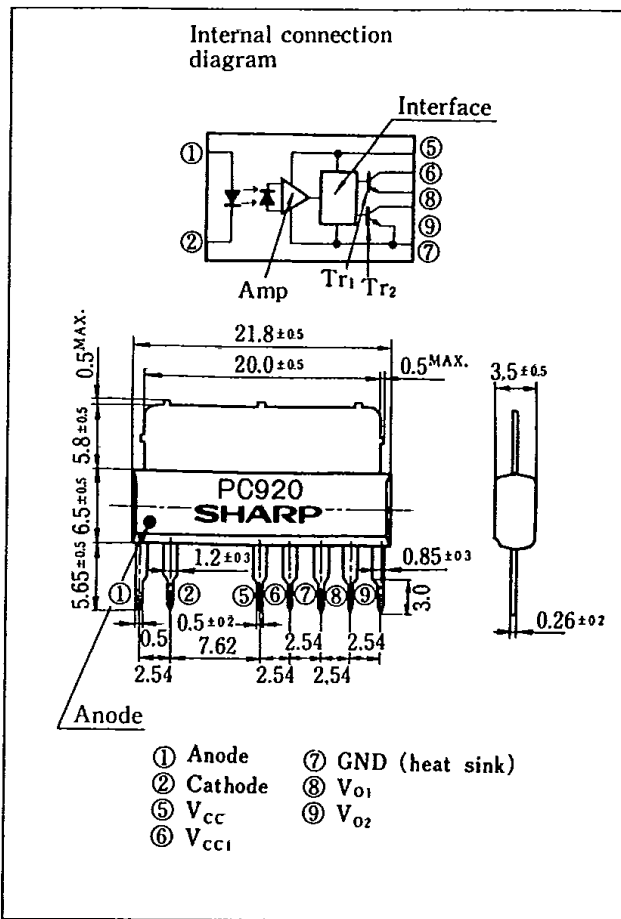

※ OPIC is a registered trademark of Sharp and stands for Optical IC. It has a light detecting element and signal processing circuitry integrated onto a single chip.

Absolute Maximum Ratings

($T_a = 25^\circ\text{C}$)

Parameter	Symbol	Rating	Unit
Input	Forward current	I_F	50 mA
	Reverse voltage	V_R	6 V
	Power dissipation	P	70 mW
Output	Supply voltage	V_{CC}	16 V
	V_{O1} output current	I_{O1}	-0.8 A
	*1 V_{O2} output current	I_{O2P}	1.6 A
	Total power dissipation	P_{tot}	1,200 mW
	*2 Isolation voltage	V_{iso}	1,500 Vrms
Operating temperature	T_{opr}	-20 ~ +80	$^\circ\text{C}$
Storage temperature	T_{stg}	-55 ~ +125	$^\circ\text{C}$
*3 Soldering temperature	T_{sol}	260	$^\circ\text{C}$

*1 Pulse width $\leq 10\mu\text{s}$, Duty ratio = 0.02

*2 RH = 40 ~ 60%, AC for 1 minute

*3 For 10 seconds

Electro-optical Characteristics

(Ta=25°C unless specified)

Parameter		Symbol	Conditions	MIN.	TYP.	MAX.	Unit		
Input	Forward voltage	V_F	$I_F=2\text{mA}$	—	1.1	1.4	V		
			$I_F=0.1\text{mA}$	0.6	0.95	—			
	Reverse current	I_R	$V_R=3\text{V}$	—	—	10	μA		
	Terminal capacitance	C_T	$V=0, f=1\text{kHz}$	—	30	80	pF		
	Operating supply voltage	V_{CC}		5.4	6.0	15	V		
Output	V_{O1} output voltage	V_{O1}	$V_{CC}=V_{CC1}=6\text{V}, I_{O1}=-0.3\text{A}, I_F=2\text{mA}$	4.5	5.2	—	V		
	V_{O2} output voltage	V_{O2}	$V_{CC}=V_{CC1}=6\text{V}, I_{O2P}=1\text{A}, I_F=0$	—	0.3	2.0	V		
	V_{O1} leak current	I_{OL1}	$V_{CC}=V_{CC1}=6\text{V}, V_{O1}=\text{GND}, I_F=0$	—	—	200	μA		
	V_{O2} leak current	I_{OL2}	$V_{CC}=V_{CC1}=6\text{V}, I_F=2\text{mA}$	—	—	200	μA		
	High level supply current	I_{CCH}	$V_{CC}=V_{CC1}=6\text{V}, I_F=2\text{mA}$	—	5	10	mA		
	Low level supply current	I_{CCL}	$V_{CC}=V_{CC1}=6\text{V}, I_F=0$	—	12	20	mA		
				$V_{CC}=V_{CC1}=6\text{V}, R_{L1}=15\Omega$	—	0.5	1.0	mA	
Transfer characteristics	**“Low→High” threshold input current		I_{FLH}	$T_a=T_{opr}, V_{CC}=V_{CC1}=6\text{V}, R_{L1}=15\Omega$	0.1	—	2.0	mA	
	Isolation resistance		R_{ISO}	DC=500V, RH=40~60%	5×10^{10}	10^{11}	—	Ω	
	Response time	“Low→High” propagation time		t_{PLH}	$V_{CC}=V_{CC1}=6\text{V}$	—	3	10	μs
		“High→Low” propagation time		t_{PHL}	$I_F=2\text{mA}$	—	3	10	
		Rise time		t_r	$R_{L1}=15\Omega$	—	0.2	2	
		Fall time		t_f	$R_{L2}=18\Omega$	—	0.2	2	

*4 I_{FLH} represents forward current when output goes from “low” to “high”.

Truth Table

Input	Output	Tr_1	Tr_2
ON	High level	ON	OFF
OFF	Low level	OFF	ON

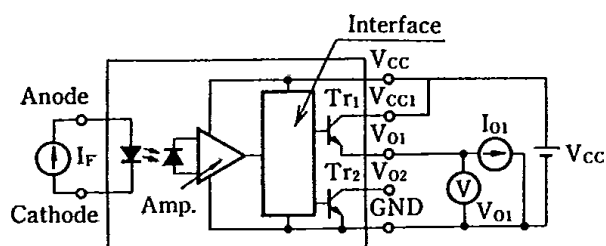
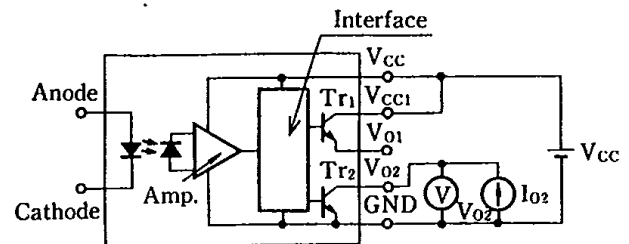
Test Circuit for V_{O1} Test Circuit for V_{O2} 

Test Circuit for I_{OL1}

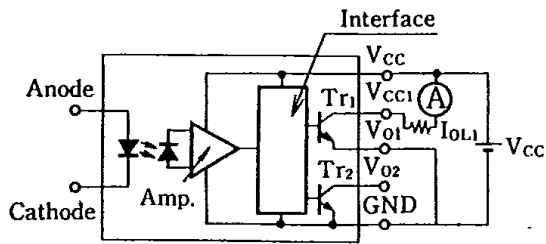

Test Circuit for I_{OL2}

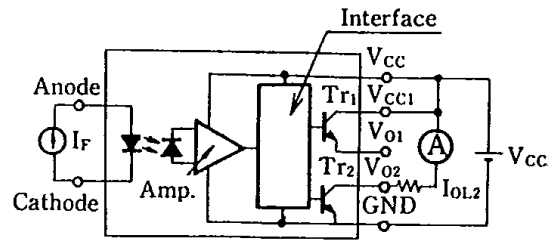

Test Circuit for Response Time

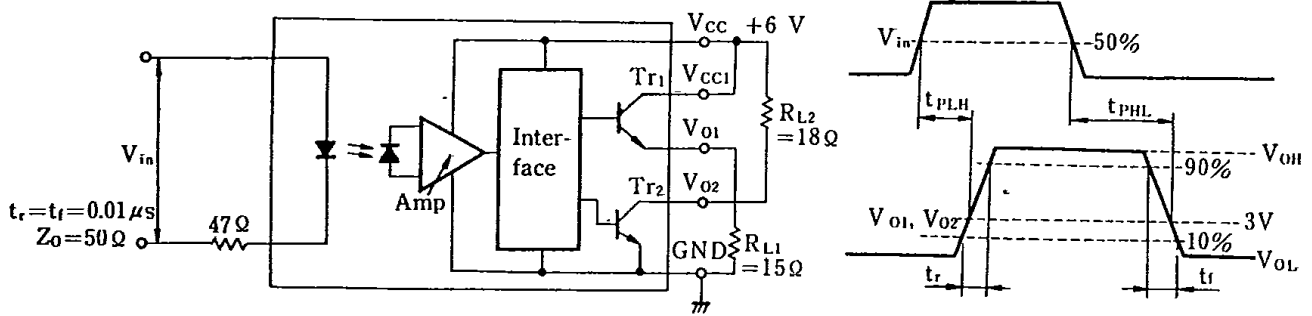

6

Fig. 1 Forward Current vs. Ambient Temperature

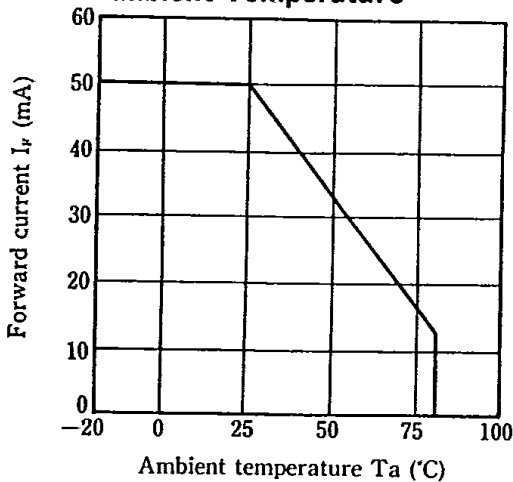

Fig. 2 Total Power Dissipation vs. Ambient Temperature

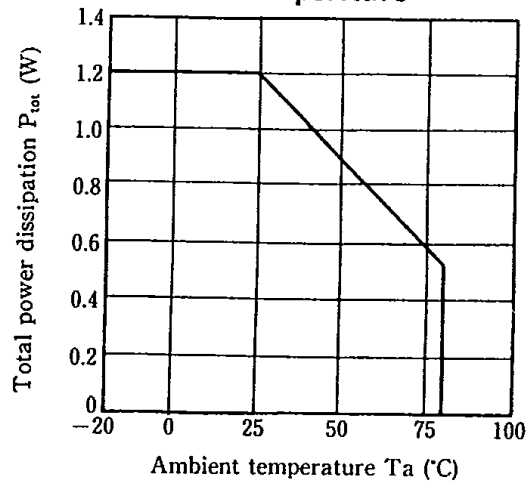

Fig. 3 Forward Current vs. Forward Voltage

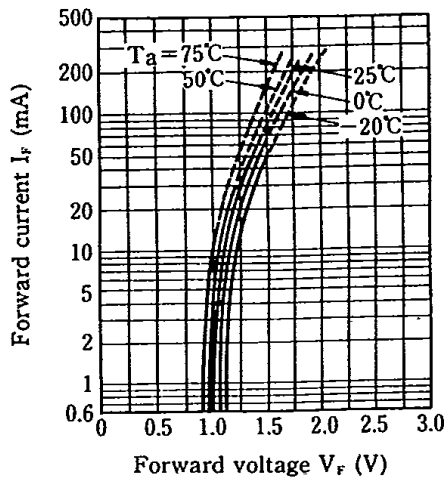

Fig. 4 Relative Threshold Input Current vs. Supply Voltage

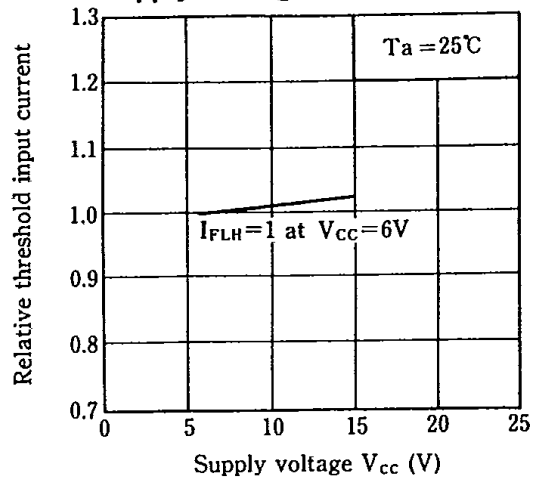

Fig. 5 Relative Threshold Input Current vs. Ambient Temperature

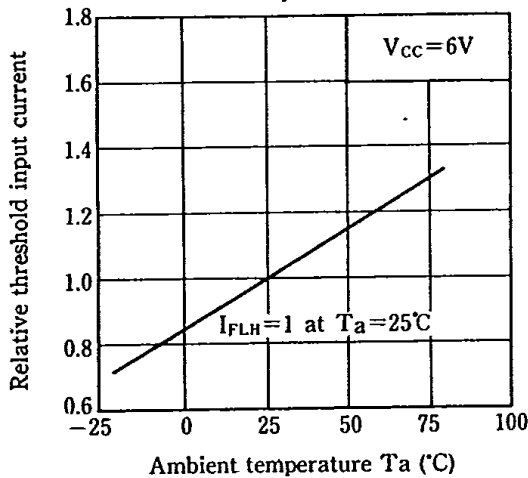

Fig. 6 Output Voltage vs. Output Current (Tr_1)

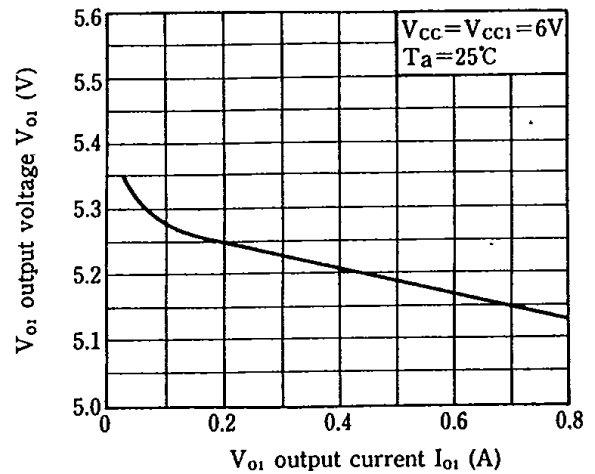

Fig. 7 Output Voltage vs. Output Current (Tr_2)

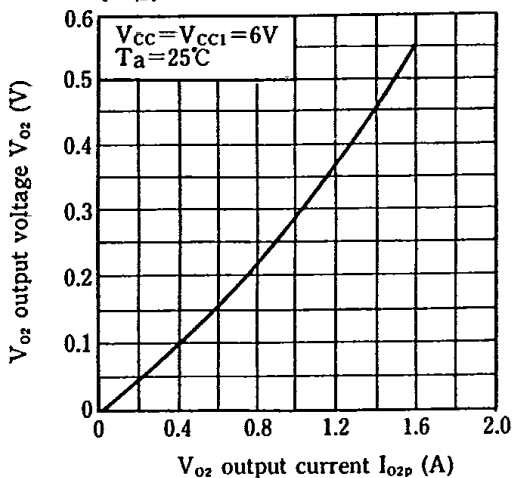

Fig. 8 Output Voltage vs. Ambient Temperature (Tr_1)

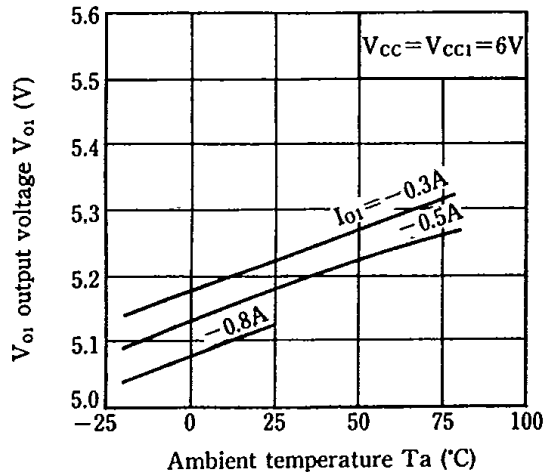

Fig. 9 Output Voltage vs. Ambient Temperature (T_r)

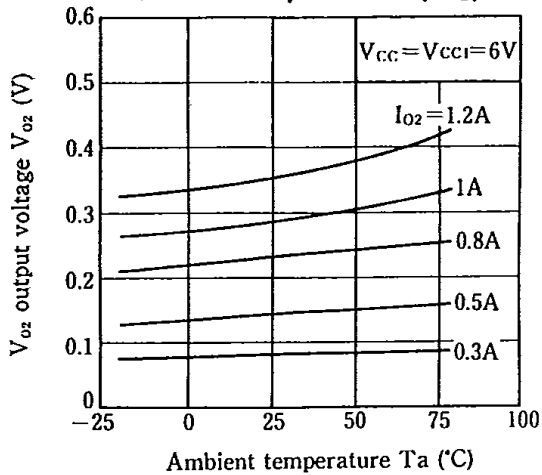

Fig. 10 Supply Current vs. Supply Voltage

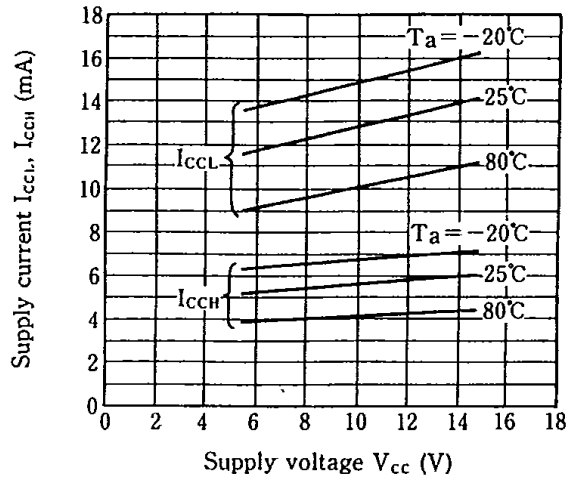

Fig. 11 Propagation Time vs. Forward Current

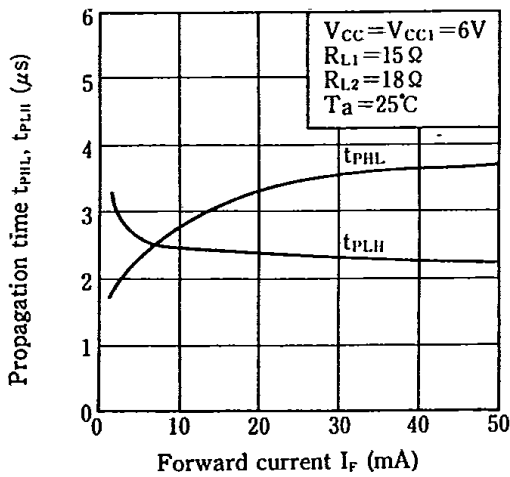
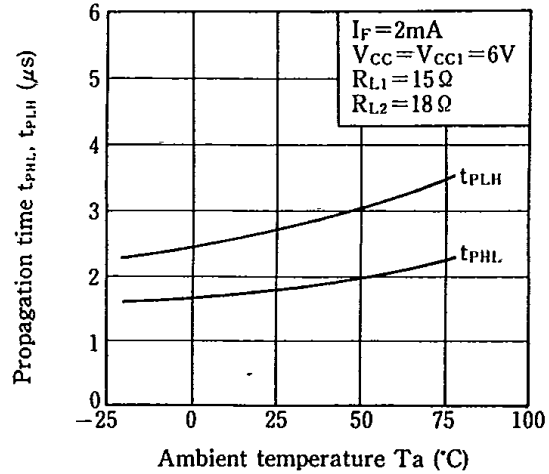

Fig. 12 Propagation Time vs. Ambient Temperature



6

Application Circuit Example

