

PC929

Shortcircuit Protector Circuit Built-in Photocoupler Suitable for Inverter-Driving MOS-FET/IGBT

* TÜV (VDE 0884) approved type is also available as an option.

■ Features

1. Built-in IGBT shortcircuit protector circuit
2. Built-in direct drive circuit for IGBT drive
(Peak output current ... I_{O1P} , I_{O2P} : MAX. 0.4A)
3. High speed response (t_{PLH} , t_{PHL} : MAX. 0.5 μ s)
4. High isolation voltage (V_{iso} : 4000V_{rms})
5. Half lead pin pitch (p=1.27 mm) package type
6. Recognized by UL, file NO. E64380

■ Application

1. IGBT control for inverter drive

■ Outline Dimensions

(Unit : mm)

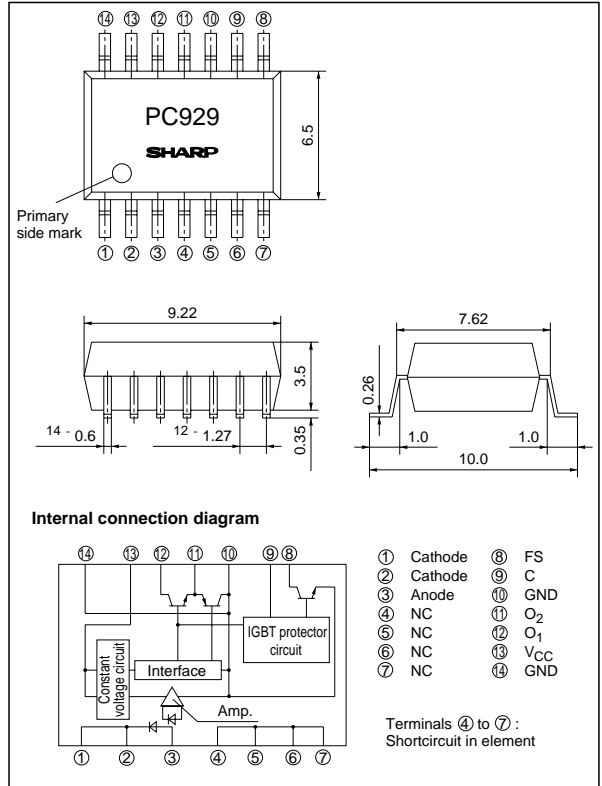

■ Absolute Maximum Ratings

($T_a = T_{opr}$ unless otherwise specified)

	Parameter	Symbol	Rating	Unit
Input	^{*1} Forward current	I_F	20	mA
	Reverse voltage	V_R	6 ($T_a = 25^\circ\text{C}$)	V
Output	Supply voltage	V_{CC}	35	V
	O ₁ output current	I_{O1}	0.1	A
	^{*4} O ₁ peak output current	I_{O1P}	0.4	A
	O ₂ output current	I_{O2}	0.1	A
	^{*4} O ₂ peak output current	I_{O2P}	0.4	A
	O ₁ output voltage	V_{O1}	35	V
	^{*2} Power dissipation	P_O	500	mW
	Overcurrent detecting voltage	V_C	V_{CC}	V
	Overcurrent detecting current	I_C	30	mA
	Error signal output voltage	V_{FS}	V_{CC}	V
Error signal output current	I_{FS}	20	mA	
^{*3} Total power dissipation	P_{tot}	550	mW	
^{*5} Isolation voltage	V_{iso}	4 000	V _{rms}	
Operating temperature	T_{opr}	- 25 to + 80	$^\circ\text{C}$	
Storage temperature	T_{stg}	- 55 to + 125	$^\circ\text{C}$	
Soldering temperature	T_{sol}	260 (for 10 sec)	$^\circ\text{C}$	

^{*1} 1, 2, 3 Decrease in the ambient temperature range of the Absolute Max. Rating : Shown in Figs 1 and 2.

^{*4} Pulse width $\leq 0.15 \mu\text{s}$, Duty ratio=0.01

^{*5} 40 to 60% RH, AC for 1 minute, $T_a=25^\circ\text{C}$

* "OPIC" (Optical IC) is a trademark of the SHARP Corporation.

An OPIC consists of a light-detecting element and signal processing circuit integrated onto a single chip.

Operation truth table is shown on the next page.

■ Electro-optical Characteristics (1)

(Ta=Topr unless otherwise specified)

Parameter		Symbol	Conditions	MIN.	TYP.	MAX.	Unit	Measuring circuit	
Input	Forward voltage	V _{F1}	T _a = 25°C, I _F = 10mA	-	1.6	1.75	V	-	
		V _{F2}	T _a = 25°C, I _F = 0.2mA	1.2	1.5	-	V	-	
	Reverse current	I _R	T _a = 25°C, V _R = 5V	-	-	10	μA	-	
	Terminal capacitance	C _t	T _a = 25°C, V = 0, f = 1kHz	-	30	250	pF	-	
Output	Operating supply voltage	V _{CC}	T _a = -10 to 60°C	15	-	30	V	-	
			-	15	-	24	V		
	O ₁ low level output voltage	V _{O1L}	V _{CC1} = 12V, V _{CC2} = -12V I _{O1} = 0.1A, I _F = 5mA *8	-	0.2	0.4	V	(1)	
	O ₂ high level output voltage	V _{O2H}	V _{CC} = V _{O1} = 24V, I _{O2} = -0.1A I _F = 5mA *8	20	22	-	V	(2)	
	O ₂ low level output voltage	V _{O2L}	V _{CC} = V _{O1} = 24V, I _{O2} = 0.1A, I _F = 0mA *8	-	1.2	2.0	V	(3)	
	O leak current	V _{O1L}	T _a = 25°C, V _{CC} = V _{O1} = 35V, I _F = 0mA *8	-	-	500	μA	(4)	
	High level supply current	I _{CCH}	T _a = 25°C, V _{CC} = V _{O1} = 24V, I _F = 5mA *8	-	10	17	mA	(6)	
V _{CC} = V _{O1} = 24V, I _F = 5mA *8			-	-	19	mA			
Low level supply current	I _{CCL}	T _a = 25°C, V _{CC} = V _{O1} = 24V, I _F = 0mA *8	-	11	18	mA	(6)		
		V _{CC} = V _{O1} = 24V, I _F = 0mA *8	-	-	20	mA			
Transfer characteristics	*7 "Low→High" threshold input current	I _{FLH}	T _a = 25°C, V _{CC} = V _{O1} = 24V *8	0.3	1.5	3.0	mA	(5)	
			V _{CC} = V _{O1} = 24V *8	0.2	-	5.0	mA		
	Isolation resistance	R _{ISO}	T _a = 25°C, DC500V, 40 to 60% RH	5 × 10 ¹⁰	1 × 10 ¹¹	-	Ω	-	
	Response time	"Low→High" propagation delay time	t _{PLH}	T _a = 25°C, V _{CC} = V _{O1} = 24V R _G = 47Ω, C _G = 3 000pF, I _F = 5mA *8	-	0.3	0.5	μs	(8)
		"High→Low" propagation delay time	t _{PHL}		-	0.3	0.5	μs	
		Rise time	t _r		-	0.2	0.5	μs	
		Fall time	t _f		-	0.2	0.5	μs	
Instantaneous common mode rejection voltage "Output : High level"	CM _H	T _a = 25°C, V _{CC} = V _{O1} = 24V, I _F = 5mA V _{CM} = 600V(peak), ΔV _{O2H} = 2.0V *8	- 1 500	-	-	V/μs	(7)		
Instantaneous common mode rejection voltage "Output : Low level"	CM _L	T _a = 25°C, V _{CC} = V _{O1} = 24V, I _F = 0mA V _{CM} = 600V(peak), ΔV _{O2L} = 2.0V *8	1 500	-	-	V/μs			

*6 When measuring output and transfer characteristics, connect a bypass capacitor (0.01 μF or more) between V_{CC} (13) and GND (14) near the device.*7 I_{FLH} represents forward current when output goes from "Low" to "High".*8 FS=OPEN, V_C=0V

■ Truth Table

Input	C Input/Output	O ₂ Output	FS Output	
ON	Low level	High level	High level	For protective operation
	High level	Low level	Low level	
OFF	Low level	Low level	High level	
	High level	Low level	High level	

■ Electro-optical Characteristics (2)

(Ta=Topr unless otherwise specified)

	Parameter	Symbol	Conditions	MIN.	TYP.	MAX.	Unit	Test circuit
⁹⁹ Overcurrent detection	¹⁰ Overcurrent detecting voltage	V _{CTH}	T _a = 25°C, I _F = 5mA V _{CC} = V _{O1} = 24V, R _G = 47Ω C _G = 3 000pF, FS = OPEN	V _{CC} -	V _{CC} -	V _{CC} -	V	(9)
	Overcurrent detecting voltage hysteresis width	V _{CHIS}		6.5	6.0	5.5		
⁹⁹ Protective output	O ₂ "High→Low" delay time at protection from overcurrent	t _{PCOHL}	T _a = 25°C V _{CC} = V _{O1} = 24V, I _F = 5mA C _G = 3 000pF, R _G = 47Ω C _P = 1 000pF, R _C = 1kΩ FS = OPEN	-	4	10	μs	(13)
	O ₂ fall time at protection from overcurrent	t _{PCOf}		2	5	-	μs	
	O ₂ output voltage at protection from overcurrent	V _{OE}		-	-	2	V	(10)
⁹⁹ Error signal output	Low level error signal voltage	V _{FSL}	T _a = 25°C, I _F = 5mA, I _{FS} = 10mA V _{CC} = V _{O1} = 24V, R _G = 47Ω, C _G = 3 000pF, C = OPEN	-	0.2	0.4	V	(11)
	High level error signal current	I _{FSH}	T _a = 25°C, I _F = 5mA, V _{FS} = 24V V _{CC} = V _{O1} = 24V, R _G = 47Ω, C _G = 3 000pF, V _C = 0V	-	-	100	μA	(12)
	Error signal "High→Low" delay time	t _{PCFHL}	T _a = 25°C, R _{FS} = 1.8kΩ V _{CC} = V _{O1} = 24V, I _F = 5mA C _G = 3 000pF, R _G = 47Ω C _P = 1 000pF, R _C = 1kΩ	-	1	5	μs	(14)
	Error signal output pulse width	Δ t _{FS}		20	35	-	μs	

⁹⁹ When measuring overcurrent, protective output and error signal output characteristics, connect a bypass capacitor (0.01 μF or more) between V_{CC} (13) and GND (14) near the device.

¹⁰ V_{CTH} represents C-terminal voltage when O₂ output goes from "High" to "Low".

Fig. 1 Forward Current vs. Ambient Temperature

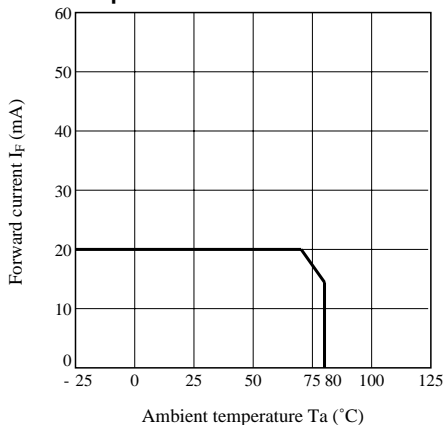
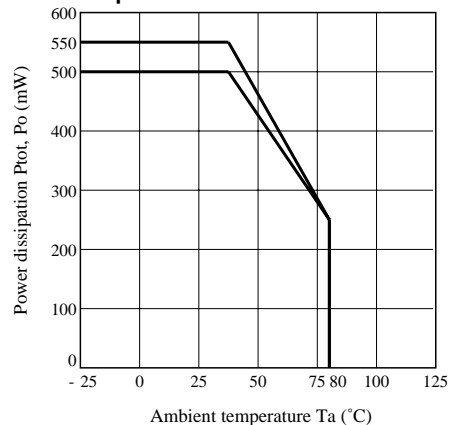
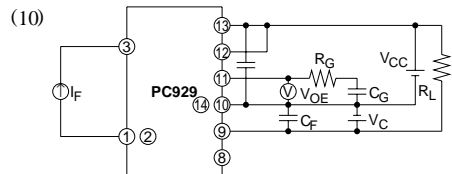
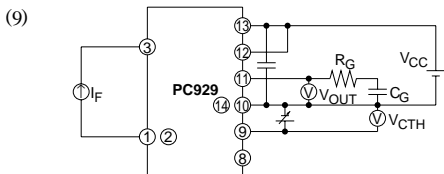
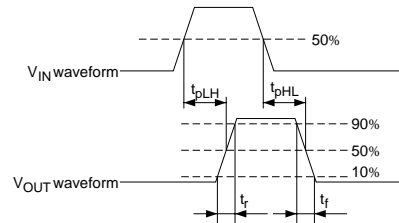
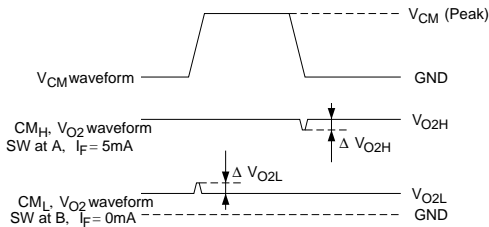
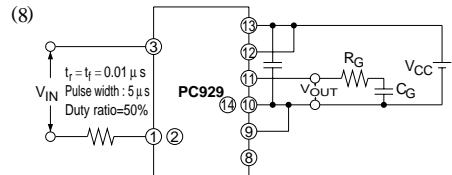
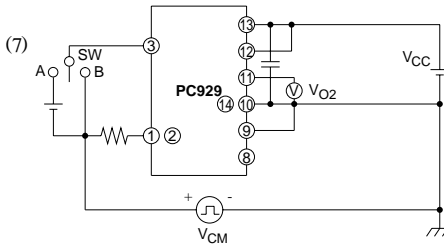
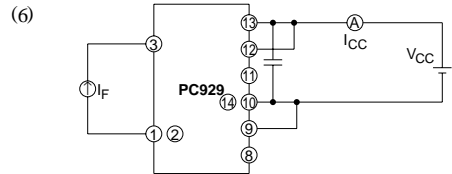
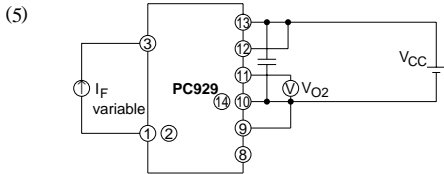
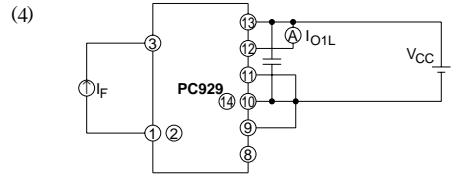
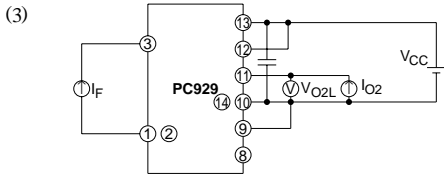
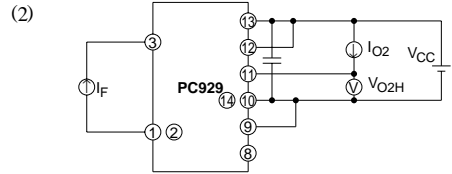
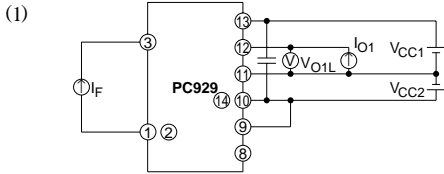

Fig. 2 Power Dissipation vs. Ambient Temperature



■ Test Circuit Diagram



Test Circuit Diagram

(11)

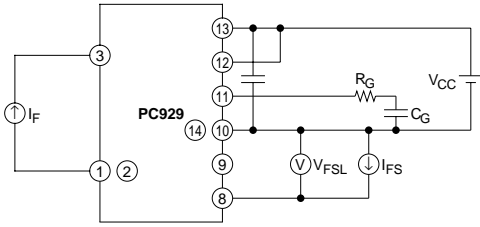

(12)

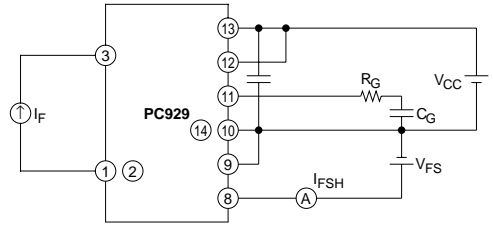

(13)

V_{OUT}

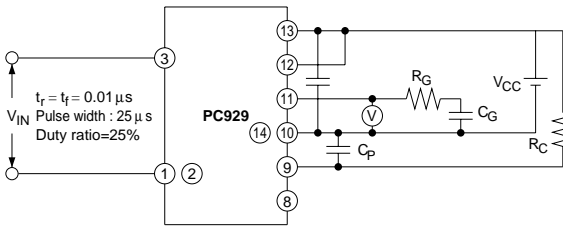

(14)

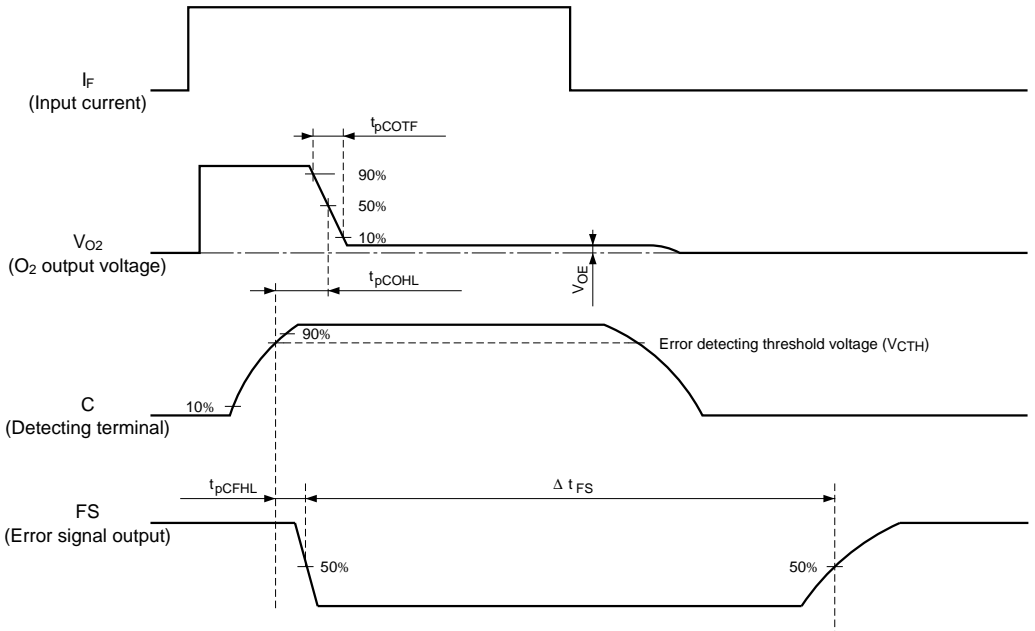
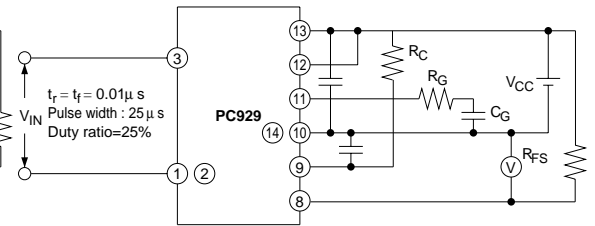

■ Operations of Shortcircuit Protector Circuit

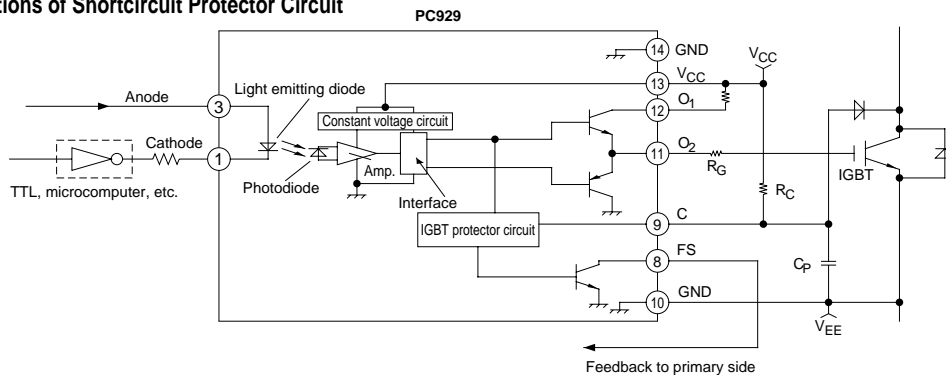

1. Detection of increase in V_{CE} (sat) of IGBT due to overcurrent by means of C-terminal (9) terminal
2. Reduction of the IGBT gate voltage, and suppression of the collector current.
3. Simultaneous output of signals to indicate the shortcircuit condition (FS signal) from FS terminal to the microcomputer
4. Judgement and processing by the microcomputer
 - In the case of instantaneous shortcircuit, run continues.
 - At fault, input to the photocoupler is cut off, and IGBT is turned OFF.

Precautions for Operation

1. It is recommended that a capacitor of about 1000pF is added between C-terminal and GND in order to prevent malfunction of C-terminal due to noise. In the case of capacitor added, rise of the detecting voltage is delayed. Thus, use together a resistance of about 1k Ω set between V_{CC} and C-terminal.
The C-terminal rise time varies with the time constant of CR added. Check sufficiently before use.
2. The light-detecting element used for this product is provided with a parasitic diode between each terminal and GND. When a terminal happens to reach electric potential lower than GND potential even in a moment, malfunction or rupture may result. Design the circuit so that each terminal will be kept at electric potential lower than the GND potential at all times.