

DATA SHEET

PCD3359A

**8-bit microcontroller with DTMF
generator and 128 bytes EEPROM**

Product specification
Supersedes data of 1996 Dec 18
File under Integrated Circuits, IC03

1998 May 11

**8-bit microcontroller with DTMF
generator and 128 bytes EEPROM****PCD3359A**

CONTENTS	9	TIMING
1 FEATURES	10	RESET
2 GENERAL DESCRIPTION	11	IDLE MODE
3 ORDERING INFORMATION	12	STOP MODE
4 BLOCK DIAGRAM	13	INSTRUCTION SET RESTRICTIONS
5 PINNING INFORMATION	14	OVERVIEW OF PORT AND POWER-ON-RESET CONFIGURATION
5.1 Pinning	15	SUMMARY OF DERIVATIVE REGISTERS
5.2 Pin descriptions	16	HANDLING
6 FREQUENCY GENERATOR	17	LIMITING VALUES
6.1 Frequency generator derivative registers	18	DC CHARACTERISTICS
6.2 Melody output (P1.7/MDY)	19	AC CHARACTERISTICS
6.3 Frequency registers	20	PACKAGE OUTLINES
6.4 DTMF frequencies	21	SOLDERING
6.5 Modem frequencies	21.1	Introduction
6.6 Musical scale frequencies	21.2	DIP
7 EEPROM AND TIMER 2 ORGANIZATION	21.3	LQFP and SO
7.1 EEPROM registers	22	DEFINITIONS
7.2 EEPROM latches	23	LIFE SUPPORT APPLICATIONS
7.3 EEPROM flags		
7.4 EEPROM macros		
7.5 EEPROM access		
7.6 Timer 2		
8 INTERRUPTS		
8.1 Derivative interrupt		
8.2 Port 0 Wake-up interrupts		

8-bit microcontroller with DTMF generator and 128 bytes EEPROM

PCD3359A

1 FEATURES

- 8-bit CPU, ROM, RAM, EEPROM and I/O; in a single 28-lead or 32-lead package
- 2-kbyte ROM
- 64-byte RAM
- 128-byte EEPROM
- OTP version available
- Over 100 instructions (based on MAB8048) all of 1 or 2 cycles
- 20 quasi-bidirectional I/O port lines
- 8-bit programmable Timer/event counter 1
- 8-bit reloadable Timer 2
- Three single-level vectored interrupts:
 - external
 - 8-bit programmable Timer/event counter 1
 - derivative; triggered by reloadable Timer 2
- Wake-up via external or Port 0 interrupt
- Two test inputs, one of which also serves as the external interrupt input
- DTMF, modem, musical tone generator
- Reference for supply and temperature-independent tone output
- Filtering for low output distortion (CEPT compatible)
- Melody output for ringer application
- Power-on-reset
- Stop and Idle modes
- Supply voltage: 1.8 to 6 V (DTMF tone output and EEPROM erase/write from 2.5 V)

- Clock frequency: 1 to 16 MHz (3.58 MHz for DTMF suggested)
- Operating temperature: –25 to +70 °C
- Manufactured in silicon gate CMOS process.

2 GENERAL DESCRIPTION

This data sheet details the specific properties of the PCD3359A. The shared properties of the PCD33xxA family of microcontrollers are described in the “PCD33xxA family” data sheet, which should be read in conjunction with this publication.

The PCD3359A is a low voltage microcontroller oriented towards telephony applications. It includes an on-chip generator for dual tone multifrequency (DTMF) generator, modem and musical tones. In addition to dialling, generated frequencies can be made available as square waves (P1.7/MDY) for melody generation, providing ringer operation (in which case the TONE output is disabled). A wake-up function via Port 0 interrupt facilitates keyboard interfacing. The PCD3359A can be emulated with the OTP microcontroller PCD3756A.

The device also incorporates 128 bytes of Electrically Erasable Programmable Read-Only Memory (EEPROM). The EEPROM can be used for storing telephone numbers, particularly for implementing redial functions.

The instruction set is similar to that of the MAB8048 and is a sub-set of that listed in the “PCD33xxA family” data sheet.

3 ORDERING INFORMATION

TYPE NUMBER ⁽¹⁾	PACKAGE		
	NAME	DESCRIPTION	VERSION
PCD3359AP	DIP28	plastic dual in-line package; 28 leads (600 mil)	SOT117-1
PCD3359AT	SO28	plastic small outline package; 28 leads; body width 7.5 mm	SOT136-1
PCD3359AH	LQFP32	plastic low profile quad flat package; 32 leads; body 7 × 7 × 1.4 mm	SOT358-1

Note

1. Please refer to the Order Entry Form (OEF) for this device for the full type number to use when ordering. This type number will also specify the required program and the ROM mask options.

8-bit microcontroller with DTMF generator and 128 bytes EEPROM

PCD3359A

4 BLOCK DIAGRAM

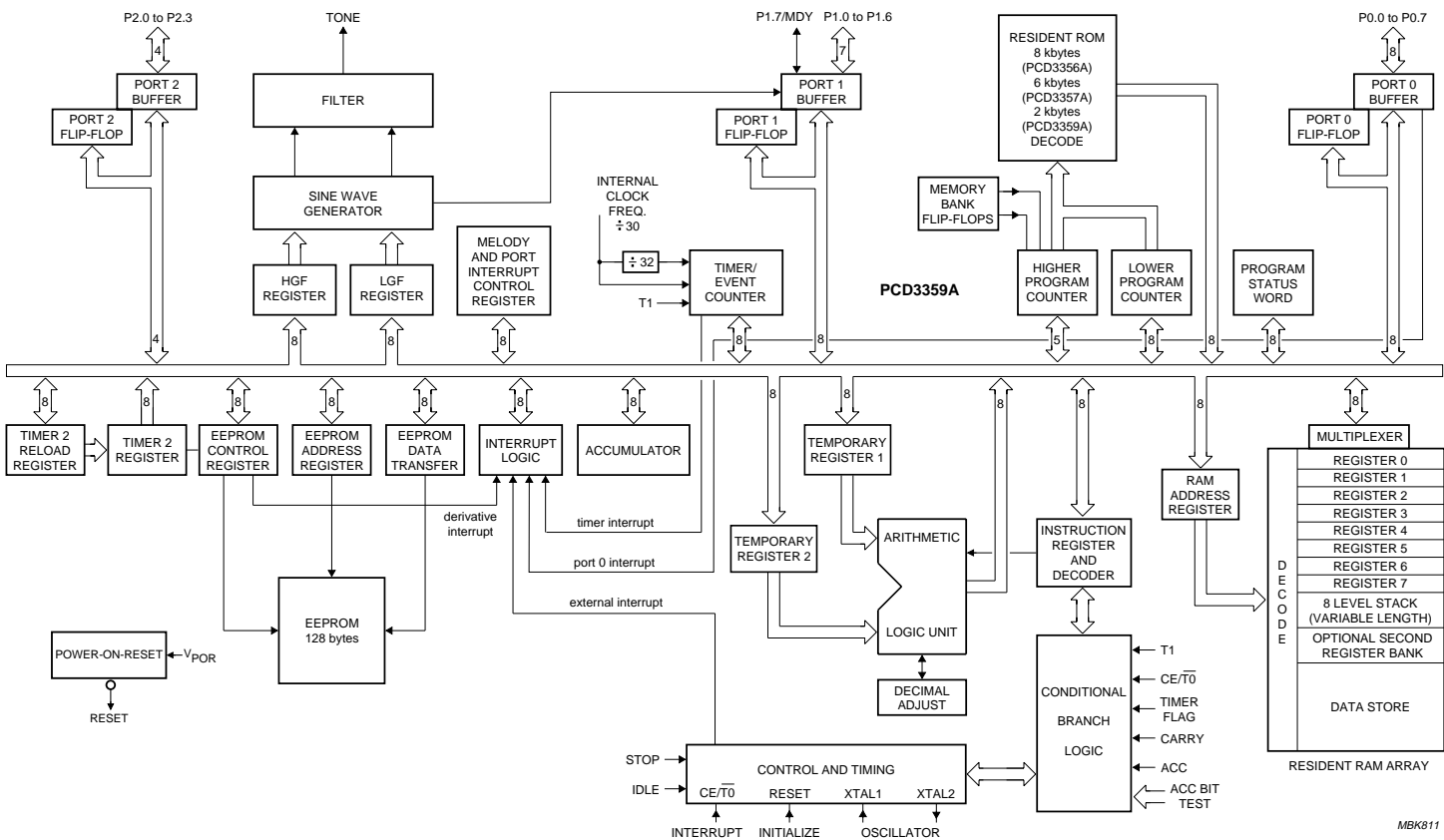

Fig.1 Block diagram.

8-bit microcontroller with DTMF generator and 128 bytes EEPROM

PCD3359A

5 PINNING INFORMATION

5.1 Pinning

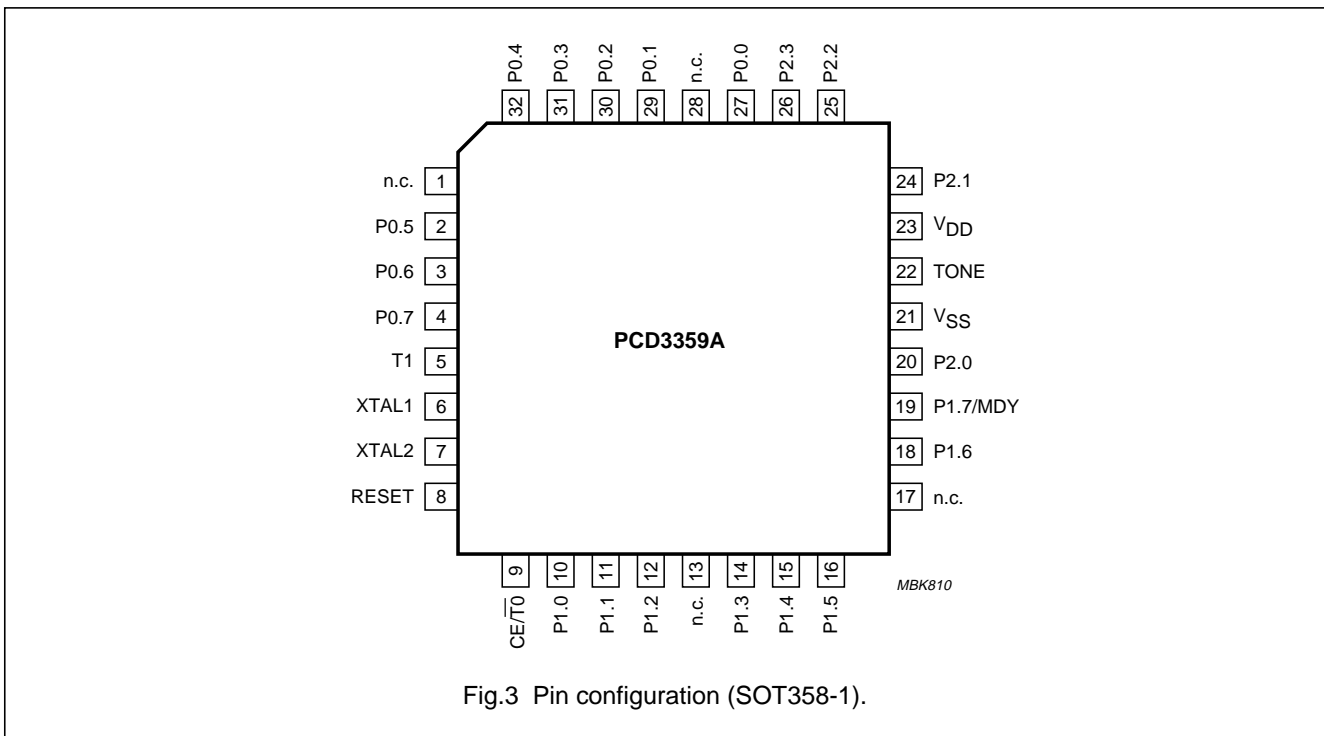
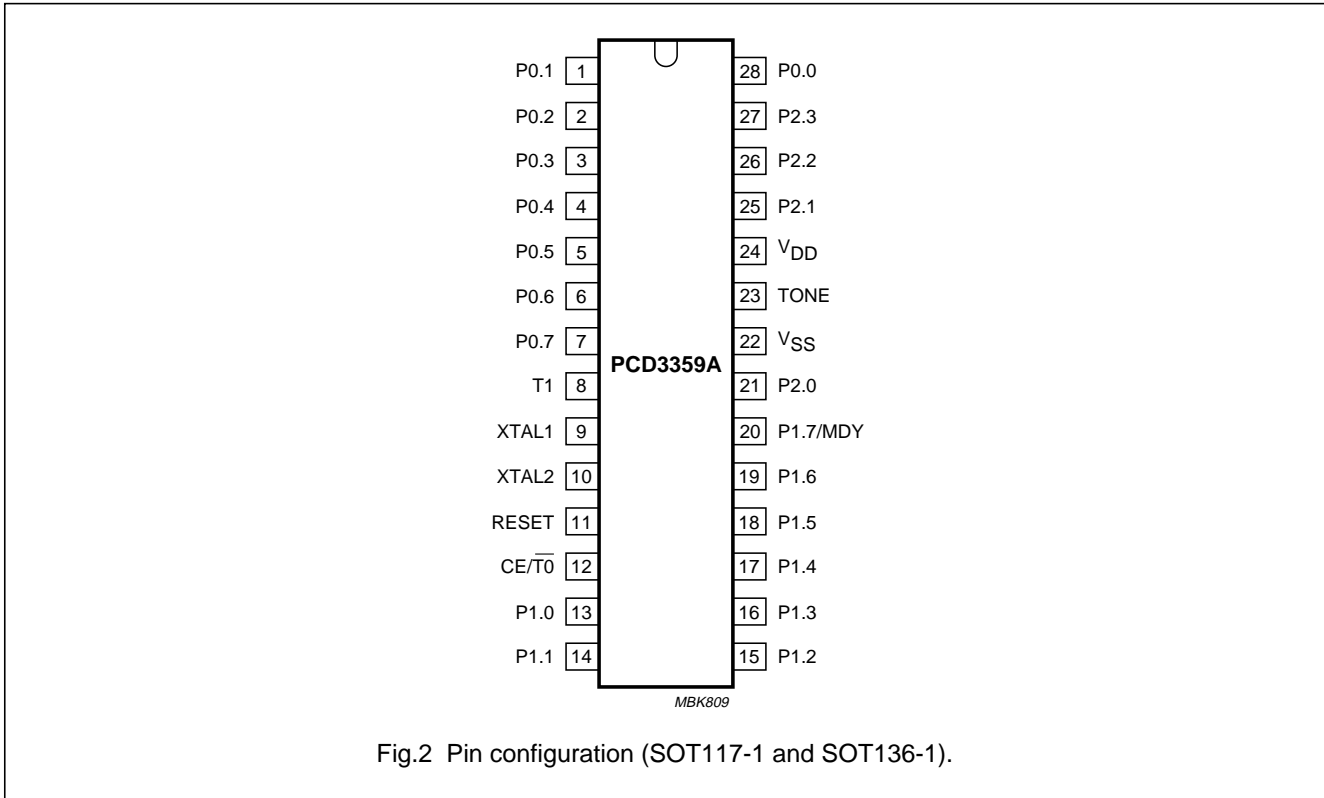

8-bit microcontroller with DTMF generator and 128 bytes EEPROM

PCD3359A

5.2 Pin descriptions

Table 1 SOT117-1 and SOT136-1 packages (for information on parallel I/O ports, see Chapter 14)

SYMBOL	PIN	TYPE	DESCRIPTION
P0.1 to P0.7	1 to 7	I/O	7 bits of Port 0: 8-bit quasi-bidirectional I/O port; or wake-up interrupts
T1	8	I	Test 1 or count input of 8-bit Timer/event counter 1
XTAL1	9	I	crystal oscillator or external clock input
XTAL2	10	O	crystal oscillator output
RESET	11	I	reset input
CE/ $\overline{T0}$	12	I	Chip Enable or Test 0
P1.0 to P1.6	13 to 19	I/O	7 bits of Port 1: 8-bit quasi-bidirectional I/O port
P1.7/MDY	20	I/O	1 bit of Port 1: 8-bit quasi-bidirectional I/O port; or melody output
P2.0	21	I/O	1 bit of Port 2: 4-bit quasi-bidirectional I/O port
V _{SS}	22	P	ground
TONE	23	O	DTMF, modem, musical tone output
V _{DD}	24	P	positive supply voltage
P2.1 to P2.3	25 to 27	I/O	3 bits of Port 2: 4-bit quasi-bidirectional I/O port
P0.0	28	I/O	1 bit of Port 0: 8-bit quasi-bidirectional I/O port; or wake-up interrupts

Table 2 SOT358-1 package (for information on parallel I/O ports, see Chapter 14)

SYMBOL	PIN	TYPE	DESCRIPTION
n.c.	1, 13, 17, 28	–	not connected
P0.5 to P0.7	2 to 4	I/O	3 bits of Port 0: 8-bit quasi-bidirectional I/O port; or wake-up interrupts
T1	5	I	Test 1 or count input of 8-bit Timer/event counter 1
XTAL1	6	I	crystal oscillator or external clock input
XTAL2	7	O	crystal oscillator output
RESET	8	I	reset input
CE/ $\overline{T0}$	9	I	Chip Enable or Test 0
P1.0 to P1.6	10 to 12 14 to 16 18	I/O	7 bits of Port 1: 8-bit quasi-bidirectional I/O port
P1.7/MDY	19	I/O	1 bit of Port 1: 8-bit quasi-bidirectional I/O port; or melody output
P2.0 to P2.3	20, 24 to 26	I/O	4 bits of Port 2: 4-bit quasi-bidirectional I/O port
V _{SS}	21	P	ground
TONE	22	O	DTMF output
V _{DD}	23	P	positive supply voltage
P0.0 to P0.4	27, 29 to 32	I/O	5 bits of Port 0: 8-bit quasi-bidirectional I/O port; or wake-up interrupts

8-bit microcontroller with DTMF generator and 128 bytes EEPROM

PCD3359A

6 FREQUENCY GENERATOR

A versatile frequency generator section is provided (see Fig.4). For normal operation, use a 3.58 MHz quartz crystal or PXE resonator. The frequency generator includes precision circuitry for dual tone multifrequency (DTMF) signals, which is typically used for tone dialling telephone sets. Their frequencies are provided in purely sinusoidal form on the TONE output or as square waves on the P1.7/MDY output.

The TONE output can alternatively issue twelve modem frequencies for data rates between 300 and 1200 bits/s.

In addition to DTMF and modem frequencies, two octaves of musical scale in steps of semitones are available.

In case no tones are generated, or the melody function is used, the TONE output is in 3-state mode.

6.1 Frequency generator derivative registers

6.1.1 HIGH AND LOW GROUP FREQUENCY REGISTERS

Table 3 gives the addresses, symbols and access types of the High Group Frequency (HGF) and Low Group Frequency (LGF) Registers.

Table 3 Hexadecimal addresses, symbols, access types and bit symbols of the frequency registers

REGISTER ADDRESS	REGISTER SYMBOL	ACCESS TYPE	BIT SYMBOLS							
			7	6	5	4	3	2	1	0
11H	HGF	W	H7	H6	H5	H4	H3	H2	H1	H0
12H	LGF	W	L7	L6	L5	L4	L3	L2	L1	L0

6.1.2 MELODY AND PORT INTERRUPT CONTROL REGISTER (MDYCON)

The Melody and Port Interrupt Control Register has two functions: bit 0 defines the behaviour of the melody output; bits 4 to 7 individually enable/disable specific pairs of Port 0 interrupts. MDYCON is a R/W register.

Table 4 Melody and Port Interrupt Control Register (address 13H)

7	6	5	4	3	2	1	0
EPI3	EPI2	EPI1	EPI0	0	0	0	EMO

Table 5 Description of MDYCON bits

BIT	SYMBOL	DESCRIPTION
7 to 4	EPI3 to EPI0	Enable Port 0 interrupts. Bits 7 to 4 individually enable/disable specific pairs of Port 0 interrupts; see Table 6 and Section 8.2 for details.
3 to 1	–	These bits are set to a logic 0.
0	EMO	Enable Melody Output. If bit EMO = 0, then P1.7/MDY is a standard port line and the TONE output is enabled. If bit EMO = 1, then P1.7/MDY is the melody output and the TONE output is disabled (3-state). EMO = 1 does not inhibit the port instructions for P1.7/MDY. Therefore, the state of both port line and flip-flop may be read in and the port flip-flop may be written by port instructions. However, the port flip-flop of P1.7/MDY must remain set to avoid conflicts between melody and port outputs. When the HGF contents are zero while EMO = 1, P1.7/MDY is in the logic HIGH state.

8-bit microcontroller with DTMF generator and 128 bytes EEPROM

PCD3359A

Table 6 Port 0 Interrupts control bits

BIT	STATE	INTERRUPTS			
		P0.0 AND P0.1	P0.2 AND P0.3	P0.4 AND P0.5	P0.6 AND P0.7
EPI0	1	enabled	–	–	–
	0	disabled	–	–	–
EPI0	1	–	enabled	–	–
	0	–	disabled	–	–
EPI0	1	–	–	enabled	–
	0	–	–	disabled	–
EPI0	1	–	–	–	enabled
	0	–	–	–	disabled

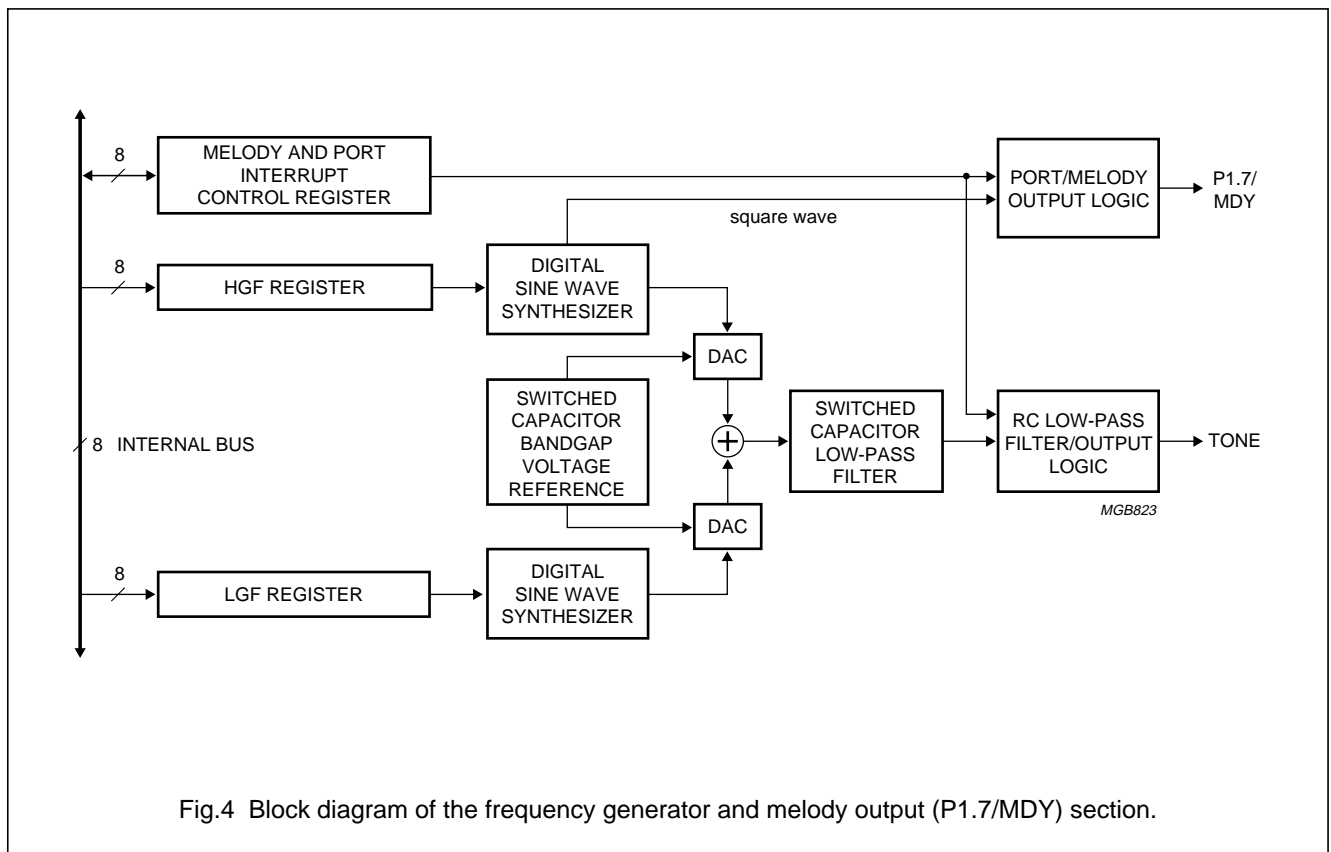

8-bit microcontroller with DTMF generator and 128 bytes EEPROM

PCD3359A

6.2 Melody output (P1.7/MDY)

The melody output (P1.7/MDY) is very useful for generating musical notes when a purely sinusoidal signal is not required, such as for ringer applications.

If bit EMO = 1 in the Melody and Port Interrupt Control Register the TONE output is disabled (3-state) and a square wave with the frequency defined by the HGF contents is output on line P1.7/MDY. The square wave (duty cycle = $12/23$ or 52%) will include the attenuated harmonics of the base frequency, which is defined by the contents of the HGF register (Table 3). However, even higher frequency notes may be produced since the low-pass filtering on the TONE output is not applied to the P1.7/MDY output. This results in the minimum decimal value x in the HGF register (see equation in Section 6.3) being 2 for the P1.7/MDY output, rather than 60 for the TONE output. A sinusoidal TONE output is produced at the same time as the melody square wave, but due to the filtering, the higher frequency sine waves with $x < 60$ will not appear at the TONE output.

Since the melody output is shared with P1.7, the port flip-flop of P1.7 has to be set HIGH before using the melody output. This is to avoid conflicts between melody and port outputs. The melody output drive depends on the configuration of port P1.7/MDY; see Chapter 14, Table 25.

6.3 Frequency registers

The two frequency registers HGF and LGF define two frequencies. From these, the digital sine synthesizers

together with the Digital-to-Analog Converters (DACs) construct two sine waves. Their amplitudes are precisely scaled according to the bandgap voltage reference. This ensures tone output levels independent of supply voltage and temperature.

The amplitude of the Low Group Frequency sine wave is attenuated by 2 dB compared to the amplitude of the High Group Frequency sine wave. The two sine waves are summed and then filtered by an on-chip switched capacitor and RC low-pass filters. These guarantee that all DTMF tones generated fulfil the CEPT recommendations with respect to amplitude, frequency deviation, total harmonic distortion and suppression of unwanted frequency components.

The value 00H in a frequency register stops the corresponding digital sine synthesizer. If both frequency registers contain 00H, the whole frequency generator is shut off, resulting in lower power consumption.

The frequency of the sine wave generated 'f' is dependent on the crystal frequency 'f_{xtal}' and the decimal value 'x' held in the frequency registers (HGF and LGF). The variables are related by the equation:

$$f = \frac{f_{xtal}}{[23(x + 2)]}; \text{ where } 60 \leq x \leq 255.$$

The frequency limitation given by $x \geq 60$ is due to the low-pass filters which would attenuate higher frequency sine waves.

8-bit microcontroller with DTMF generator and 128 bytes EEPROM

PCD3359A

6.4 DTMF frequencies

Assuming an oscillator frequency $f_{xtal} = 3.58$ MHz, the DTMF standard frequencies can be implemented as shown in Table 7.

The relationships between telephone keyboard symbols, DTMF frequency pairs and the frequency register contents are given in Table 8.

Table 7 DTMF standard frequencies and their implementation; value = LGF, HGF contents

VALUE (HEX)	FREQUENCY (Hz)		DEVIATION	
	STANDARD	GENERATED	(%)	(Hz)
DD	697	697.90	0.13	0.90
C8	770	770.46	0.06	0.46
B5	852	850.45	-0.18	-1.55
A3	941	943.23	0.24	2.23
7F	1209	1206.45	-0.21	-2.55
72	1336	1341.66	0.42	5.66
67	1477	1482.21	0.35	5.21
5D	1633	1638.24	0.32	5.24

Table 8 Dialling symbols, corresponding DTMF frequency pairs and frequency register contents

TELEPHONE KEYBOARD SYMBOLS	DTMF FREQ. PAIRS (Hz)	LGF VALUE (HEX)	HGF VALUE (HEX)
0	(941, 1336)	A3	72
1	(697, 1209)	DD	7F
2	(697, 1336)	DD	72
3	(697, 1477)	DD	67
4	(770, 1209)	C8	7F
5	(770, 1336)	C8	72
6	(770, 1477)	C8	67
7	(852, 1209)	B5	7F
8	(852, 1336)	B5	72
9	(852, 1477)	B5	67
A	(697, 1633)	DD	5D
B	(770, 1633)	C8	5D
C	(852, 1633)	B5	5D
D	(941, 1633)	A3	5D
•	(941, 1209)	A3	7F
#	(941, 1477)	A3	67

6.5 Modem frequencies

Again assuming an oscillator frequency $f_{xtal} = 3.58$ MHz, the standard modem frequencies can be implemented as in Table 9. It is suggested to define the frequency by the HGF register while the LGF register contains 00H, disabling Low Group Frequency generation.

Table 9 Standard modem frequencies and their implementation

HGF VALUE (HEX)	FREQUENCY (Hz)		DEVIATION	
	MODEM	GENERATED	(%)	(Hz)
9D	980 ⁽¹⁾	978.82	-0.12	-1.18
82	1180 ⁽¹⁾	1179.03	-0.08	-0.97
8F	1070 ⁽²⁾	1073.33	0.31	3.33
79	1270 ⁽²⁾	1265.30	-0.37	-4.70
80	1200 ⁽³⁾	1197.17	-0.24	-2.83
45	2200 ⁽³⁾	2192.01	-0.36	-7.99
76	1300 ⁽⁴⁾	1296.94	-0.24	-3.06
48	2100 ⁽⁴⁾	2103.14	0.15	3.14
5C	1650 ⁽¹⁾	1655.66	0.34	5.66
52	1850 ⁽¹⁾	1852.77	0.15	2.77
4B	2025 ⁽²⁾	2021.20	-0.19	-3.80
44	2225 ⁽²⁾	2223.32	-0.08	-1.68

Notes

- Standard is V.21.
- Standard is Bell 103.
- Standard is Bell 202.
- Standard is V.23.

8-bit microcontroller with DTMF generator and 128 bytes EEPROM

PCD3359A

6.6 Musical scale frequencies

Finally, two octaves of musical scale in steps of semitones can be realized, again assuming an oscillator frequency $f_{\text{xtal}} = 3.58$ MHz (Table 10). It is suggested to define the frequency by the HGF register while the LGF contains 00H, disabling Low Group Frequency generation.

Table 10 Musical scale frequencies and their implementation

NOTE	HGF VALUE (HEX)	FREQUENCY (Hz)	
		STANDARD ⁽¹⁾	GENERATED
D#5	F8	622.3	622.5
E5	EA	659.3	659.5
F5	DD	698.5	697.9
F#5	D0	740.0	741.1
G5	C5	784.0	782.1
G#5	B9	830.6	832.3
A5	AF	880.0	879.3
A#5	A5	923.3	931.9
B5	9C	987.8	985.0
C6	93	1046.5	1044.5
C#6	8A	1108.7	1111.7
D6	82	1174.7	1179.0
D#6	7B	1244.5	1245.1
E6	74	1318.5	1318.9
F6	6D	1396.9	1402.1
F#6	67	1480.0	1482.2
G6	61	1568.0	1572.0
G#6	5C	1661.2	1655.7
A6	56	1760.0	1768.5
A#6	51	1864.7	1875.1
B6	4D	1975.5	1970.0
C7	48	2093.0	2103.3
C#7	44	2217.5	2223.3
D7	40	2349.3	2358.1
D#7	3D	2489.0	2470.4

Note

1. Standard scale based on A4 at 440 Hz.

7 EEPROM AND TIMER 2 ORGANIZATION

The PCD3359A has 128 bytes of Electrically Erasable Programmable Read-Only Memory (EEPROM). Such non-volatile storage provides data retention without the need for battery backup. In telecom applications, the EEPROM is used for storing redial numbers and for short dialling of frequently used numbers. More generally, EEPROM may be used for customizing microcontrollers, such as to include a PIN code or a country code, to define trimming parameters, to select application features from the range stored in ROM.

The most significant difference between a RAM and an EEPROM is that a bit in EEPROM, once written to a logic 1, cannot be cleared by a subsequent write operation. Successive write accesses actually perform a logical OR with the previously stored information. Therefore, to clear a bit, the whole byte must be erased and re-written with the particular bit cleared. Thus, an erase-and-write operation is the EEPROM equivalent of a RAM write operation.

Whereas read access times to an EEPROM are comparable to RAM access times, write and erase accesses are much slower at 5 ms each. To make these operations more efficient, several provisions are available.

First, the EEPROM array is structured into 32 four-byte pages (see Fig.5) permitting access to 4 bytes in parallel (write page, erase/write page and erase page). It is also possible to erase and write individual bytes. Finally, the EEPROM address register provides auto-incrementing, allowing very efficient read and write accesses to sequential bytes.

To simplify the erase and write timing, the derivative 8-bit down-counter (Timer 2) with reload register is provided. In addition to EEPROM timing, Timer 2 can be used for general real-time tasks, such as for measuring signal duration and for defining pulse widths.

8-bit microcontroller with DTMF generator and 128 bytes EEPROM

PCD3359A

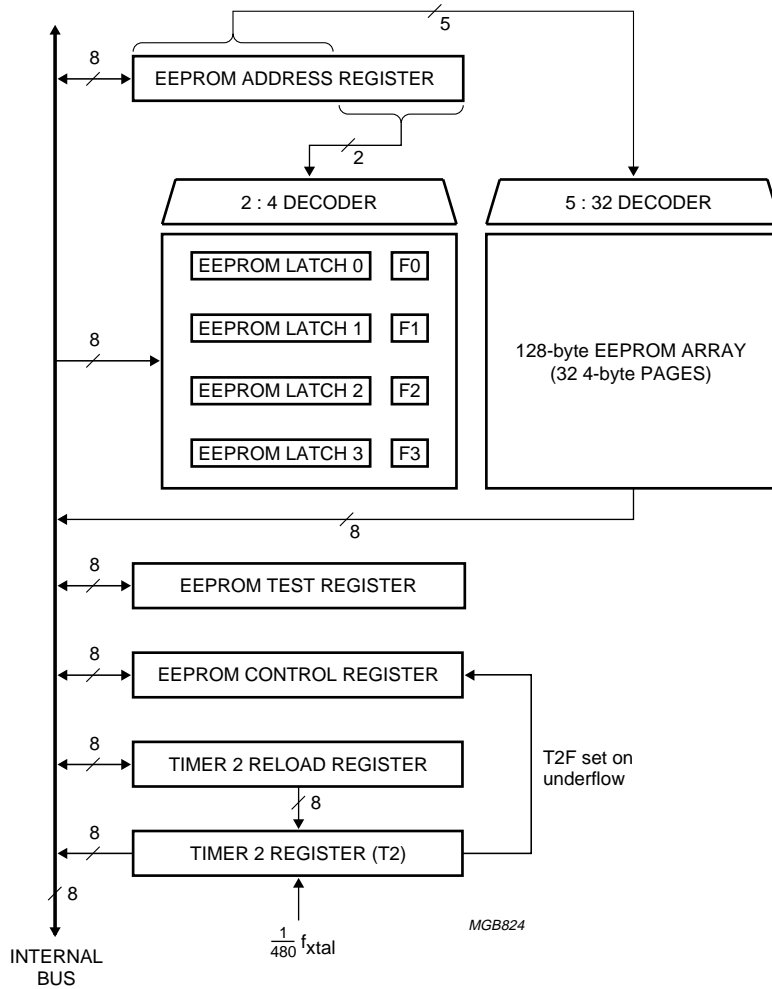

Fig.5 Block diagram of the EEPROM and Timer 2.

8-bit microcontroller with DTMF generator and 128 bytes EEPROM

PCD3359A

7.1 EEPROM registers

7.1.1 EEPROM CONTROL REGISTER (EPCR)

The behaviour of the EEPROM and Timer 2 section is defined by the EEPROM Control Register. See Tables 11, 12 and 13.

Table 11 EEPROM Control Register, EPCR (address 04H, access type R/W)

7	6	5	4	3	2	1	0
STT2	ET2I	T2F	EWP	MC3	MC2	MC1	0

Table 12 Description of EPCR bits

BIT	SYMBOL	DESCRIPTION
7	STT2	Start T2. If STT2 = 0, then Timer 2 is stopped; T2 value held. If STT2 = 1, then T2 decrements from reload value.
6	ET2I	Enable T2 interrupt. If ET2I = 0, then T2F event cannot request interrupt. If ET2I = 1, then T2F event can request interrupt.
5	T2F	Timer 2 flag. Set when T2 underflows (or by program); reset by program.
4	EWP	Erase or write in progress. Set by program (EWP starts EEPROM erase and/or write and Timer 2). Reset at the end of EEPROM erase and/or write.
3	MC3	Mode control 3 to 1. These three bits in conjunction with bit EWP select the mode as shown in Table 13.
2	MC2	
1	MC1	
0	–	This bit is set to a logic 0.

Table 13 Mode selection; X = don't care

EWP	MC3	MC2	MC1	DESCRIPTION
0	0	0	0	read byte
0	0	1	0	increment mode
1	0	1	X	write page
1	1	0	0	erase/write page
1	1	1	1	erase page
X	0	0	1	not allowed
X	1	0	1	
X	1	1	0	

8-bit microcontroller with DTMF generator and 128 bytes EEPROM

PCD3359A

7.1.2 EEPROM ADDRESS REGISTER (ADDR)

The EEPROM Address Register determines the EEPROM location to which an EEPROM access is directed.

As a whole, ADDR auto-increments after read and write cycles to EEPROM, but remains fixed after erase cycles. This behaviour generates the correct ADDR contents for sequential read accesses and for sequential write or erase/write accesses with intermediate page setup. Overflow of the 8-bit counter wraps around to zero.

Table 14 EEPROM Address Register, ADDR (address 01H, access type R/W)

7	6	5	4	3	2	1	0
0	AD6	AD5	AD4	AD3	AD2	AD1	AD0

Table 15 Description of ADDR bits

BIT	SYMBOL	DESCRIPTION
7	–	This bit is set to a logic 0.
6 to 2	AD6 to AD2	AD2 to AD6 select one of 32 pages.
1 to 0	AD1 to AD0	AD1 and AD0 are irrelevant during erase and write cycles. For read accesses, AD0 and AD1 indicate the byte location within an EEPROM page. During page setup, finally, AD0 and AD1 select EEPROM Latch 0 to 3 whereas AD2 to AD6 are irrelevant. If increment mode (Table 13) is active during page setup, the subcounter consisting of AD0 and AD1 increments after every write to an EEPROM latch, thus enhancing access to sequential EEPROM latches. Incrementing stops when EEPROM Latch 3 is reached, i.e. when AD0 and AD1 are both a logic 1.

7.1.3 EEPROM DATA REGISTER (DATR)

Table 16 EEPROM Data Register (address 03H; access type R/W)

7	6	5	4	3	2	1	0
D7	D6	D5	D4	D3	D2	D1	D0

Table 17 Description of DATR bits

BIT	SYMBOL	DESCRIPTION
7 to 0	D7 to D0	The EEPROM Data Register (DATR) is only a conceptual entity. A read operation from DATR, reads out the EEPROM byte addressed by ADDR. On the other hand, a write operation to DATR, loads data into the EEPROM latch (see Fig.5) defined by bits AD0 and AD1 of ADDR.

7.1.4 EEPROM TEST REGISTER (TST)

The EEPROM Test Register is used for testing purposes during device manufacture. It must not be accessed by the device user.

7.2 EEPROM latches

The four EEPROM latches (EEPROM Latch 0 to 3; Fig.5) cannot be read by user software. Due to their construction, the latches can only be preset, but not cleared. Successive write operations through DATR to the EEPROM latches actually perform a logical OR with the previously stored data in EEPROM. The EEPROM latches are reset at the conclusion of any EEPROM cycle.

8-bit microcontroller with DTMF generator and 128 bytes EEPROM

PCD3359A

7.3 EEPROM flags

The four EEPROM flags (F0 to F3; Fig.5) cannot be directly accessed by user software. An EEPROM flag is set as a side-effect when the corresponding EEPROM latch is written through DATR. The EEPROM flags are reset at the conclusion of any EEPROM cycle.

7.4 EEPROM macros

The instruction sequence used in an EEPROM access should be treated as an indivisible entity. Erroneous programs result if ADDR, DATR, RELR or EPCR are inadvertently changed during an EEPROM cycle or its setup. Special care should be taken if the program may asynchronously divert due to an interrupt. Particularly, a new access to the EEPROM may only be initiated when no write, erase or erase/write cycles are in progress. This can be verified by reading bit EWP (register EPCR).

For write, erase and erase/write cycles, it is assumed that the Timer 2 Reload Register (RELR) has been loaded with the appropriate value for a 5 ms delay, which depends on f_{xtal} (see Table 24). The end of a write, erase or erase/write cycle will be signalled by a cleared EWP and by a Timer 2 interrupt provided that ET2I = 1 and that the SIO/derivative interrupt is enabled.

7.5 EEPROM access

One read, one write, one erase/write and one erase access are defined by bits EWP and MC1 to MC3 in the EPCR register; see Table 11.

Read byte retrieves the EEPROM byte addressed by ADDR when DATR is read. Read cycles are instantaneous.

Write and erase cycles take 5 ms, however. Erase/write is a combination of an erase and a subsequent write cycle, consequently taking 10 ms.

As their names imply, **write page**, **erase page** and **erase/write page** are applied to a whole EEPROM page. Therefore, bits AD0 and AD1 of register ADDR (see Table 14), defining the byte location within an EEPROM page, are irrelevant during write and erase cycles. However, write and erase cycles need not affect all bytes of the page. The EEPROM flags F0 to F3 (see Fig.5) determine which bytes within the EEPROM page are affected by the erase and/or write cycles. A byte whose corresponding EEPROM flag is zero remains unchanged.

With erase page, a byte is erased if its corresponding EEPROM flag is set. With write page, data in EEPROM

Latch 0 to 3 (Fig.5) are ORed to the individual page bytes if and only if the corresponding EEPROM flags are set.

In an erase/write cycle, F0 to F3 select which page bytes are erased and ORed with the corresponding EEPROM latches.

ORing, in this event, means that the EEPROM latches are copied to the selected page bytes.

The described page-wise organization of erase and write cycles allows up to four bytes to be individually erased or written within 5 ms. This advantage necessitates a preparation step, called **page setup**, before the actual erase and/or write cycle can be executed.

Page setup controls EEPROM latches and EEPROM flags. This will be described in the Sections 7.5.1 to 7.5.5.

7.5.1 PAGE SETUP

Page setup is a preparation step required before write page, erase page and erase/write page cycles.

As previously described, these page operations include single-byte write, erase and erase/write as a special event. EEPROM flags F0 to F3 determine which page bytes will be affected by the mentioned page operations. EEPROM Latch 0 to 3 must be preset through DATR to specify the write cycle data to EEPROM and to set the EEPROM flags as a side-effect. Obviously, the actual preset value of the EEPROM latches is irrelevant for erase page. Preset of one, two, three or all four EEPROM latches and the corresponding EEPROM flags can be performed by repeatedly defining ADDR and writing to DATR (see Table 18).

If more than one EEPROM latch must be preset, the subcounter consisting of AD0 and AD1 can be induced to auto-increment after every write to DATR, thus stepping through all EEPROM latches. For this purpose, increment mode (Table 13) must be selected. Auto-incrementing stops at EEPROM Latch 3. It is not mandatory to start at EEPROM Latch 0 as in shown in Table 19.

Note that AD2 to AD6 are irrelevant during page setup. They will usually specify the intended EEPROM page, anticipating the subsequent page cycle.

From now on, it will be assumed that AD2 to AD6 will contain the intended EEPROM page address after page setup.

8-bit microcontroller with DTMF generator and 128 bytes EEPROM

PCD3359A

Table 18 Page setup; preset

INSTRUCTION	RESULT
MOV A, #addr	address of EEPROM latch
MOV ADDR, A	send address to ADDR
MOV A, #data	load write, erase/write or erase data
MOV DATR, A	send data to addressed EEPROM latch

Table 19 Page setup; auto-incrementing

INSTRUCTION	RESULT
MOV A, #MC2	increment mode control word
MOV EPCR, A	select increment mode
MOV A, #baddr	EEPROM Latch 0 address (AD0 = AD1 = 0)
MOV ADDR, A	send EEPROM Latch 0 address to ADDR
MOV A, R0	load 1 st byte from Register 0
MOV DATR, A	send 1 st byte to EEPROM Latch 0
MOV A, R1	load 2 nd byte from Register 1
MOV DATR, A	send 2 nd byte to EEPROM Latch 1
MOV A, R2	load 3 rd byte from Register 2
MOV DATR, A	send 3 rd byte to EEPROM Latch 2
MOV A, R3	load 4 th byte from Register 3
MOV DATR, A	send 4 th byte to EEPROM Latch 3

7.5.2 READ BYTE

Since ADDR auto-increments after a read cycle regardless of the page boundary, successive bytes can efficiently be read by repeating the last instruction.

Table 20 Read byte

INSTRUCTION	RESULT
MOV A, #RDADDR	load read address
MOV ADDR, A	send address to ADDR
MOV A, DATR	read EEPROM data

7.5.3 WRITE PAGE

The write cycle performs a logical OR between the data in the EEPROM latches and that in the addressed EEPROM page. To actually copy the data from the EEPROM latches, the corresponding bytes in the page should previously have been erased.

The EEPROM latches are preset as described in Section 7.5.1. The actual transfer to the EEPROM is then performed as shown in Table 21.

The last instruction also starts Timer 2. The data in the EEPROM latches are ORed with that in the corresponding page bytes within 5 ms. A single-byte write is simply a special case of 'write page'.

ADDR auto-increments after the write cycle. If AD0 and AD1 addressed EEPROM Latch 3 prior to the write cycle, ADDR will point to the next EEPROM page (by bits AD2 to AD6) and to EEPROM Latch 0 (by bits AD0 and AD1). This allows efficient coding of multi-page write operations.

Table 21 Write page

INSTRUCTION	RESULT
MOV A, #EWP + MC2	'write page' control word
MOV EPCR, A	start 'write page' cycle

7.5.4 ERASE/WRITE PAGE

The EEPROM latches are preset as described in Section 7.5.1. The page byte corresponding to the asserted flags (among F0 to F3) are erased and re-written with the contents of the respective EEPROM latches.

The last instruction also starts Timer 2. Erasure takes 5 ms upon which Timer Register T2 reloads for another 5 ms cycle for writing. The top cycles together take 10 ms. A single-byte erase/write is simply a special event of 'erase/write page'.

ADDR auto-increments after the write cycle. If AD0 and AD1 addressed EEPROM latch 3 prior to the write cycle, ADDR will point to the next EEPROM page (by AD2 to AD6) and to EEPROM latch 0 (by AD0 and AD1). This allows efficient coding of multi-page erase/write operations.

Table 22 Erase/write page

INSTRUCTION	RESULT
MOV A, #EWP + MC3	'erase/write page' control word
MOV EPCR, A	start 'erase/write page' cycle

8-bit microcontroller with DTMF generator and 128 bytes EEPROM

PCD3359A

7.5.5 ERASE PAGE

The EEPROM flags are set as described in Section 7.5.1. The corresponding page bytes are erased.

The last instruction also starts Timer 2. Erasure takes 5 ms. A single-byte erase is simply a special case of 'erase page'.

Note that ADDR does not auto-increment after an erase cycle.

Table 23 Erase page

INSTRUCTION	RESULT
MOV A, #EWP + MC3 + MC2 + MC1	'erase page' control word
MOV EPCR, A	start 'erase page' cycle

7.6 Timer 2

Timer 2 is a 8-bit down-counter decremented at a rate of $\frac{1}{480} \times f_{xtal}$. It may be used either for EEPROM timing or as a general purpose timer. Conflicts between the two applications should be carefully avoided.

7.6.1 TIMER 2 FOR EEPROM TIMING

When used for EEPROM timing, Timer 2 serves to generate the 5 ms intervals needed for erasing or writing the EEPROM. At the decrement rate of $\frac{1}{480} \times f_{xtal}$, the reload value for a 5 ms interval is a function of f_{xtal} . Table 24 summarizes the required reload values for a number of oscillator frequencies.

Timer 2 is started by setting bit EWP in the EPCR. The Timer Register T2 is loaded with the reload value from RELR. T2 decrements to zero.

For an erase/write cycle, underflow of T2 indicates the end of the erase operation. Therefore, Timer Register T2 is reloaded from RELR for another 5 ms interval during which the flagged EEPROM latches are copied to the corresponding bytes in the page addressed by ADDR.

The second underflow of an erase/write cycle and the first underflow of write page and erase page conclude the corresponding EEPROM cycle. Timer 2 is stopped, T2F is set whereas EWP and MC1 to MC3 are cleared.

Table 24 Reload values as a function of f_{xtal}

f_{xtal} (MHz)	RELOAD VALUE ⁽¹⁾ (HEX)
1	0A
2	14
3.58	25
6	3E
10	68
16	A6

Note

- The reload value is $(5 \times 10^{-3} \times \frac{1}{480} f_{xtal}) - 1$; f_{xtal} in MHz.

7.6.2 TIMER 2 AS A GENERAL PURPOSE TIMER

When used for purposes other than EEPROM timing, Timer 2 is started by setting STT2. The Timer Register T2 (see Table 26) is loaded with the reload value from RELR. T2 decrements to zero. On underflow, T2 is reloaded from RELR, T2F is set and T2 continues to decrement.

Timer 2 can be stopped at any time by clearing STT2. The value of T2 is then held and can be read out. After setting STT2 again, Timer 2 decrements from the reload value. Alternatively, it is possible to read T2 'on the fly' i.e. while Timer 2 is operating.

8-bit microcontroller with DTMF generator and 128 bytes EEPROM

PCD3359A

8 INTERRUPTS

8.1 Derivative interrupt

One derivative interrupt event is defined. It is controlled by bits T2F and ET2I in the EPCR (see Tables 11 and 12).

The derivative interrupt event occurs when T2F is set. This request is honoured under the following circumstances:

- No interrupt routine proceeds
- No external interrupt request is pending
- The derivative interrupt is enabled
- ET2I is set.

The derivative interrupt routine must include instructions that will remove the cause of the derivative interrupt by explicitly clearing T2F. If the derivative interrupt is not used, T2F may directly be tested by the program. Obviously, T2F can also be asserted under program control, e.g. to generate a software interrupt.

8.2 Port 0 Wake-up interrupts

In addition to the external interrupt CE, the PCD3359A contain 8 level-sensitive external interrupt sources on Port 0. This function generates an interrupt request if any of the enabled lines of Port 0 (P0.0 to P0.7) is pulled LOW. Like the external interrupt (and contrary to the derivative interrupt) the Port 0 interrupt operates also in Stop mode and forces the CPU to exit the Stop mode.

The Port 0 Wake-up interrupts are controlled by the Enable Port 0 Interrupt bits EPI3 to EPI0 in the Melody and Port Interrupt Control Register MDYCON. Pairs of Port 0 interrupts are individually enabled/disabled via bits 4, 5, 6 and 7. For details see Section 6.1.2. As the Port 0 interrupt is directly linked to the external interrupt, it uses the same flag (EIF), enable instructions (EN I, DIS I) and interrupt vector.

A Port 0 Wake-up interrupt is serviced if:

- No interrupt routine is in progress
- The external interrupt is enabled
- It's corresponding enable bit in register MDYCON is set to a logic 1.

If a Port 0 interrupt is to be used, the port flip-flop must first be set to a logic 1 (set to input mode) before it's corresponding EPI_n bit is set.

If only a portion of the Port 0 interrupts are used, the remaining port lines may still be used as normal I/O.

In order to configure an I/O as an input, a logic 1 must first be written to it. If a logic 0 is written to one of these port lines (e.g. ANL P0, 00H) while it's corresponding interrupt is enabled, a Port 0 interrupt will be generated.

For more details see data sheet "PCD33xxA Family; Section External Interrupt".

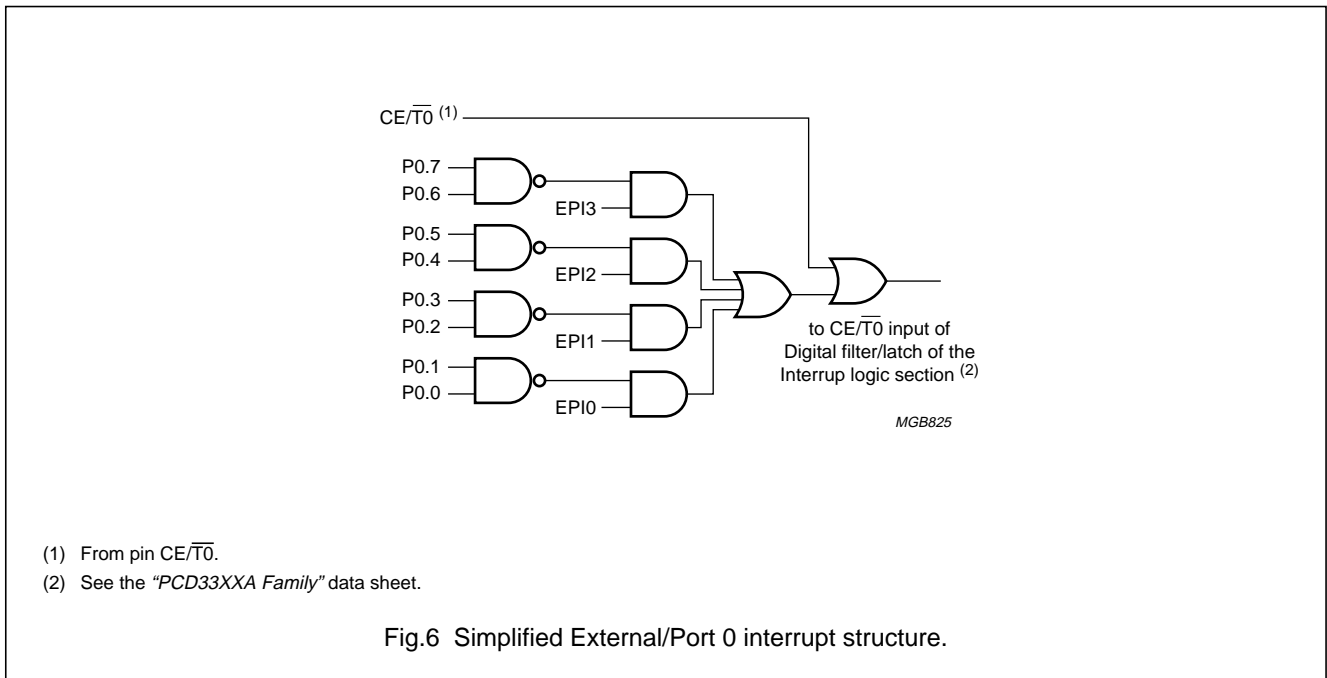

Fig.6 Simplified External/Port 0 interrupt structure.

8-bit microcontroller with DTMF generator and 128 bytes EEPROM

PCD3359A

9 TIMING

Although the PCD3359A operates over a clock frequency range from 1 to 16 MHz, $f_{xtal} = 3.58$ MHz will usually be chosen to take full advantage of the frequency generator section.

10 RESET

In addition to the conditions given in the "PCD33XXA Family" data sheet, all derivative registers are cleared in the reset state.

11 IDLE MODE

In Idle mode, the frequency generator, the EEPROM and the Timer 2 sections remain operative. Therefore, the IDLE instruction may be executed while an erase and/or write access to EEPROM is in progress.

12 STOP MODE

Since the oscillator is switched off, the frequency generator, the EEPROM and the Timer 2 sections receive no clock. It is suggested to clear both the HGF and the LGF registers before entering Stop mode. This will cut off the biasing of the internal amplifiers, considerably reducing current requirements.

The Stop mode **must not** be entered while an erase and/or write access to EEPROM is in progress. The STOP instruction may only be executed when EWP in EPCR is

zero. The Timer 2 section is frozen during Stop mode. After exit from Stop mode by a HIGH level on $\overline{CE/T0}$, Timer 2 proceeds from the held state.

The Port 0 Wake-up interrupt function remains operative during Stop mode (depending only on the EPIn bits in register MDYCON). In addition to the description in the "PCD33xxA family" data sheet, Stop mode may be left by a Port 0 Wake-up interrupt event (see Section 8.2).

13 INSTRUCTION SET RESTRICTIONS

Please note the following:

- ROM space being restricted to 2 kbytes, the 'SEL MB1/2/3' instructions would define non-existing program memory banks and should therefore be avoided
- RAM space being restricted to 64 bytes, care should be taken to avoid accesses to non-existing RAM locations.

14 OVERVIEW OF PORT AND POWER-ON-RESET CONFIGURATION

All standard quasi-bidirectional I/O ports are available; see "PCD33xxA family" data sheet.

- Port 0: 8 parallel port lines P0.0 to P0.7 or wake-up interrupts
- Port 1: 8 parallel port lines P1.0 to P1.7
- Port 2: 4 parallel port lines P2.0 to P2.3.

Table 25 Port and Power-on-reset configuration

See notes 1 and 2.

COVERED BY OTP	PORT 0								PORT 1								PORT 2				V _{POR}
	0	1	2	3	4	5	6	7	0	1	2	3	4	5	6	7	0	1	2	3	
PCD3756A	1S	1S	1S	1S	1S	1S	1S	1S	1S	1S	1S	1S	1S	1S	1R	1R ⁽³⁾	2S	2S	2S	2S	1.3 V

Notes

1. Port output drive: 1 = standard I/O; 2 = open-drain I/O, see "PCD33xxA family" data sheet.
2. Port state after reset: S = Set (HIGH) and R = Reset (LOW).
3. The melody output drive type is push-pull.

8-bit microcontroller with DTMF generator and 128 bytes EEPROM

PCD3359A

15 SUMMARY OF DERIVATIVE REGISTERS

Table 26 Register map

ADDR. (HEX)	REGISTER	7	6	5	4	3	2	1	0	R/W
00	not used									
01	EEPROM Address Register (ADDR)	0	AD6	AD5	AD4	AD3	AD2	AD1	AD0	R/W
02	not used									
03	EEPROM Data Register (DATR)	D7	D6	D5	D4	D3	D2	D1	D0	R/W
04	EEPROM Control Register (EPCR)	STT2	ET21	TF2	EWP	MC3	MC2	MC1	0	R/W
05	Timer 2 Reload Register (RELR)	R7	R6	R5	R4	R3	R2	R1	R0	R/W
06	Timer 2 Register (T2)	T2.7	T2.6	T2.5	T2.4	T2.3	T2.2	T2.1	T2.0	R
07	Test Register (TST)	only for test purposes; not to be accessed by the device user								
08 to 10	not used									
11	High Group Frequency Register (HGF)	H7	H6	H5	H4	H3	H2	H1	H0	W
12	Low Group Frequency Register (LGF)	L7	L6	L5	L4	L3	L2	L1	L0	W
13	Melody and Port Interrupt Control Register (MDYCON)	EPI3	EPI2	EPI1	EPI0	0	0	0	EMO	R/W
14 to FF	not used									

16 HANDLING

Inputs and outputs are protected against electrostatic discharge in normal handling. However, it is good practice to take normal precautions appropriate to handling MOS devices (see "Data Handbook IC14, Section: Handling MOS devices").

17 LIMITING VALUES

In accordance with the Absolute Maximum Rating System (IEC 134).

SYMBOL	PARAMETER	MIN.	MAX.	UNIT
V_{DD}	supply voltage	-0.8	+7.0	V
V_I	all input voltages	-0.5	$V_{DD} + 0.5$	V
I_I	DC input current	-10	+10	mA
I_O	DC output current	-10	+10	mA
P_{tot}	total power dissipation	-	125	mW
P_O	power dissipation per output	-	30	mW
I_{SS}	ground supply current	-50	+50	mA
T_{stg}	storage temperature	-65	+150	°C
T_j	operating junction temperature	-	90	°C

8-bit microcontroller with DTMF generator and 128 bytes EEPROM

PCD3359A

18 DC CHARACTERISTICS

$V_{DD} = 1.8$ to 6 V; $V_{SS} = 0$ V; $T_{amb} = -25$ to $+70$ °C; all voltages with respect to V_{SS} ; $f_{xtal} = 3.58$ MHz; unless otherwise specified.

SYMBOL	PARAMETER	CONDITIONS	MIN.	TYP.	MAX.	UNIT
Supply						
V_{DD}	supply voltage	see Fig.7	1.8	–	6	V
	operating RAM data retention in Stop mode	note 1	1.0	–	6	V
I_{DD}	operating supply current	see Figs 8 and 9; note 2	–	0.8	1.6	mA
		$V_{DD} = 3$ V; value HGF or LGF $\neq 0$	–	0.35	0.7	mA
		$V_{DD} = 3$ V	–	1.5	4.0	mA
		$V_{DD} = 5$ V; $f_{xtal} = 10$ MHz	–	2.4	6.0	mA
$I_{DD(idle)}$	supply current (Idle mode)	see Figs 10 and 11; note 2	–	0.7	1.4	mA
		$V_{DD} = 3$ V; value HGF or LGF $\neq 0$	–	0.25	0.5	mA
		$V_{DD} = 3$ V	–	1.1	3.4	mA
		$V_{DD} = 5$ V; $f_{xtal} = 10$ MHz	–	1.7	5.0	mA
$I_{DD(stp)}$	supply current (Stop mode)	see Fig.12; note 3	–	1.0	5.5	μ A
		$V_{DD} = 1.8$ V; $T_{amb} = 25$ °C	–	–	10	μ A
V_{IL}	LOW level input voltage		0	–	$0.3V_{DD}$	V
			$0.7V_{DD}$	–	V_{DD}	V
V_{IH}	HIGH level input voltage		$0.7V_{DD}$	–	V_{DD}	V
I_{LI}	input leakage current	$V_{SS} \leq V_I \leq V_{DD}$	–1	–	+1	μ A
Port outputs						
I_{OL}	LOW level port sink current	$V_{DD} = 3$ V; $V_O = 0.4$ V; see Fig.13	0.7	3.5	–	mA
I_{OH}	HIGH level pull-up output source current	$V_{DD} = 3$ V; $V_O = 2.7$ V; see Fig.14	–10	–30	–	μ A
		$V_{DD} = 3$ V; $V_O = 0$ V; see Fig.14	–	–140	–300	μ A
I_{OH1}	HIGH level push-pull output source current	$V_{DD} = 3$ V; $V_O = 2.6$ V; see Fig.15	–0.7	–3.5	–	mA
Tone output (see Fig.16; note 4)						
$V_{HG(RMS)}$	HGF voltage (RMS value)		158	181	205	mV
$V_{LG(RMS)}$	LGF voltage (RMS value)		125	142	160	mV
$\Delta f/f$	frequency deviation		–0.6	–	+0.6	%
V_{DC}	DC voltage level		–	$0.5V_{DD}$	–	V
$ Z_o $	output impedance		–	100	500	Ω
G_v	pre-emphasis of group		1.5	2.0	2.5	dB
THD	total harmonic distortion	$T_{amb} = 25$ °C; note 5	–	25	–	dB

8-bit microcontroller with DTMF generator and 128 bytes EEPROM

PCD3359A

SYMBOL	PARAMETER	CONDITIONS	MIN.	TYP.	MAX.	UNIT
EEPROM (notes 1 and 6)						
$CY_{t/w}$	endurance (erase/write cycles)	note 7	10^5	–	–	
t_{ret}	data retention time		10	–	–	years
Power-on reset (see Fig.17)						
V_{POR}	Power-on-reset level	configuration as PCD3756A; (see Table 25)	0.8	1.3	1.8	V
Oscillator (see Fig.18)						
g_m	transconductance	$V_{DD} = 5 V$	0.2	0.4	1.0	mS
R_F	feedback resistor		0.3	1.0	3.0	M Ω

Notes

1. TONE output, EEPROM erase and write require $V_{DD} \geq 2.5 V$.
2. $V_{IL} = V_{SS}$; $V_{IH} = V_{DD}$; open-drain outputs connected to V_{SS} ; all other outputs open; value HGF = LGF = 0, unless otherwise specified.
 - a) Maximum values: external clock at XTAL1 and XTAL2 open-circuit.
 - b) Typical values: $T_{amb} = 25 \text{ }^\circ\text{C}$; crystal connected between XTAL1 and XTAL2.
3. $V_{IL} = V_{SS}$; $V_{IH} = V_{DD}$; RESET, T1 and CE/T0 at V_{SS} ; crystal connected between XTAL1 and XTAL2; pins T1 and CE/T0 at V_{SS} .
4. Values are specified for DTMF frequencies only (CEPT).
5. Related to the Low Group Frequency (LGF) component (CEPT).
6. After final testing the value of each EEPROM bit is a logic 1, but this cannot be guaranteed after board assembly.
7. Verified on sampling basis.

8-bit microcontroller with DTMF generator and 128 bytes EEPROM

PCD3359A

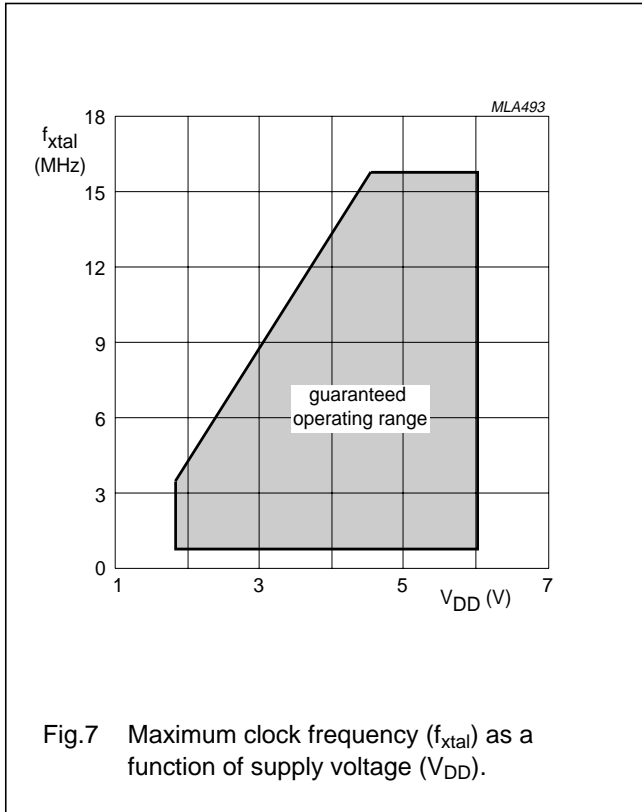
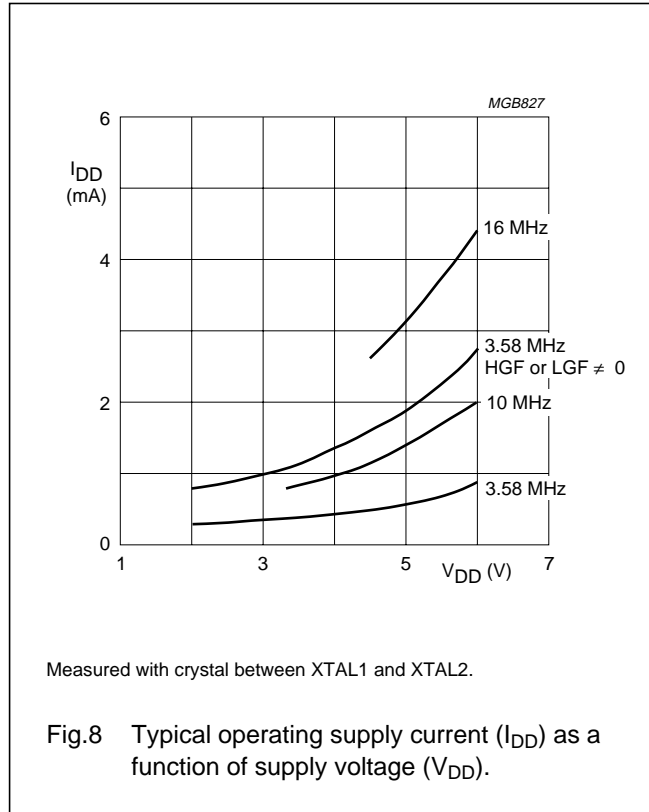
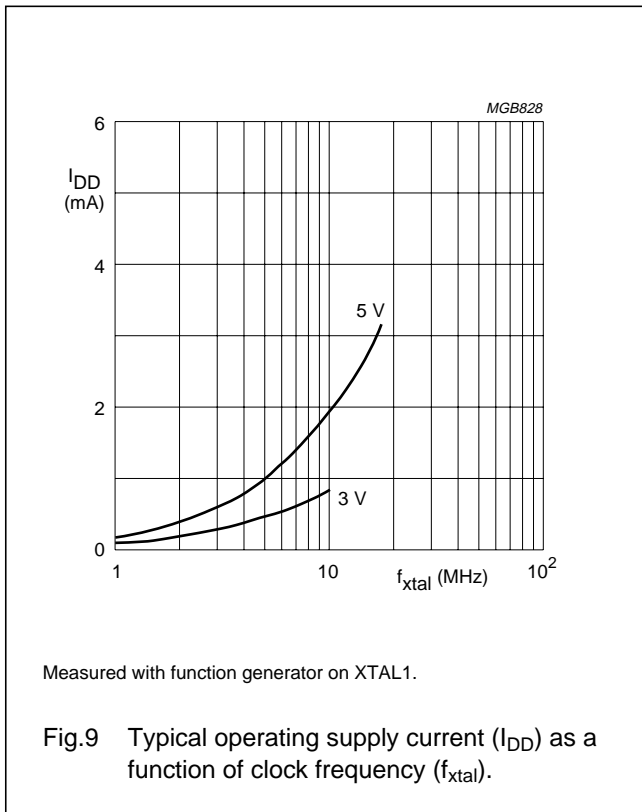

Fig.7 Maximum clock frequency (f_{xtal}) as a function of supply voltage (V_{DD}).



Measured with crystal between XTAL1 and XTAL2.

Fig.8 Typical operating supply current (I_{DD}) as a function of supply voltage (V_{DD}).



Measured with function generator on XTAL1.

Fig.9 Typical operating supply current (I_{DD}) as a function of clock frequency (f_{xtal}).

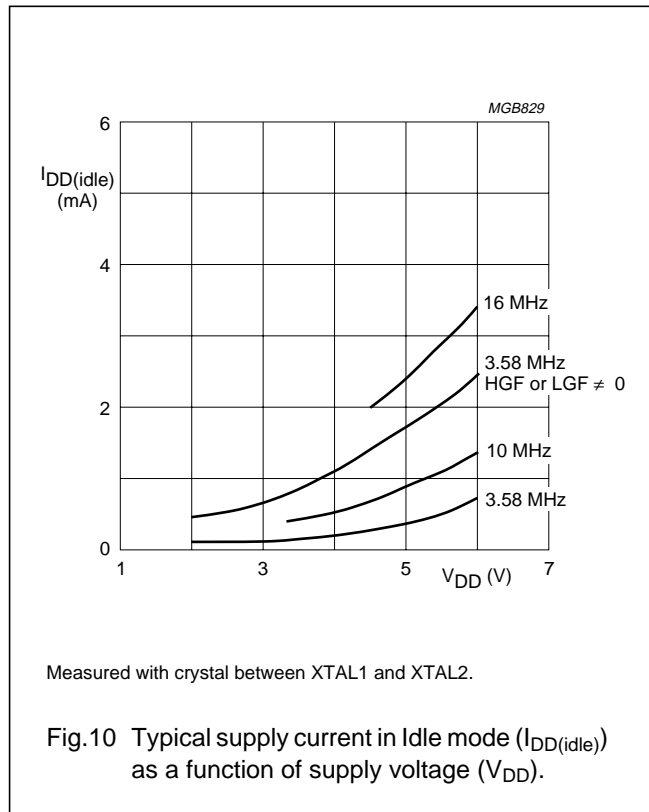

Measured with crystal between XTAL1 and XTAL2.

Fig.10 Typical supply current in Idle mode ($I_{DD(idle)}$) as a function of supply voltage (V_{DD}).

8-bit microcontroller with DTMF generator and 128 bytes EEPROM

PCD3359A

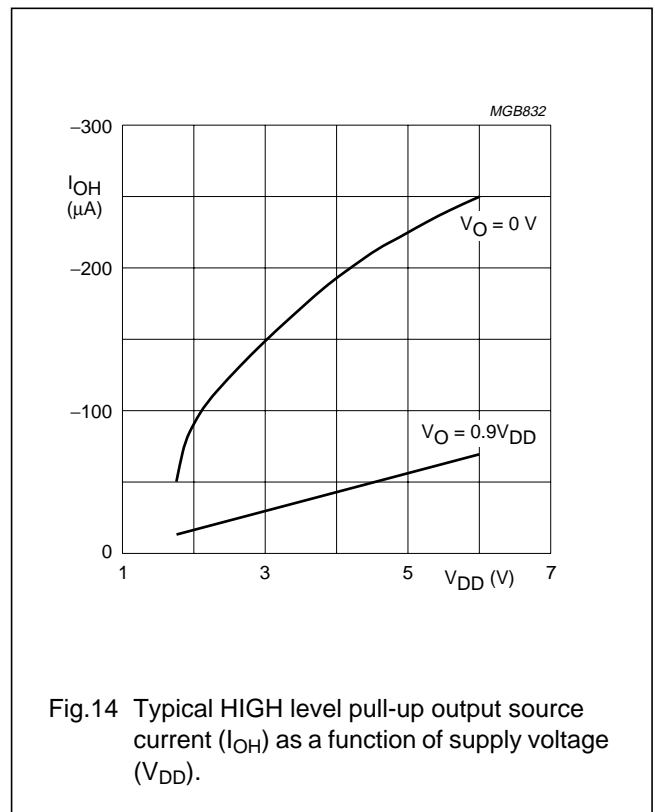
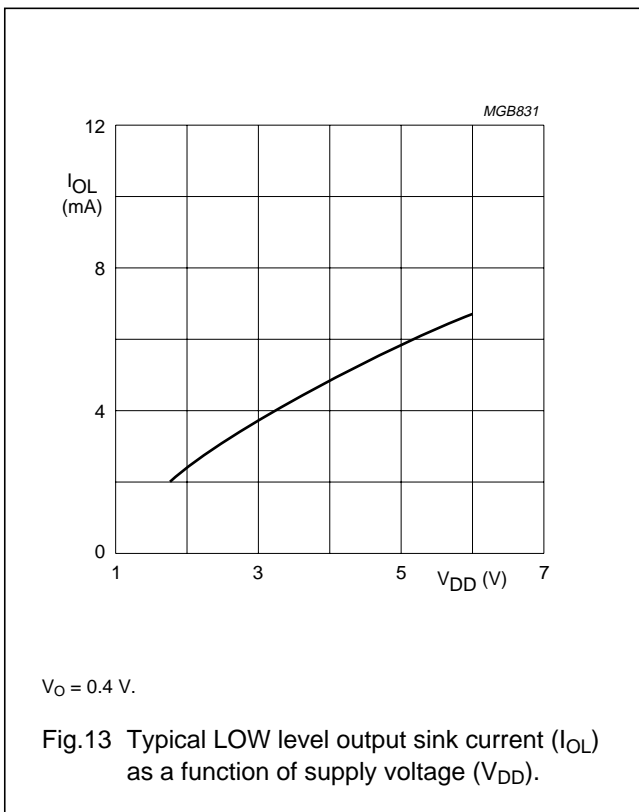
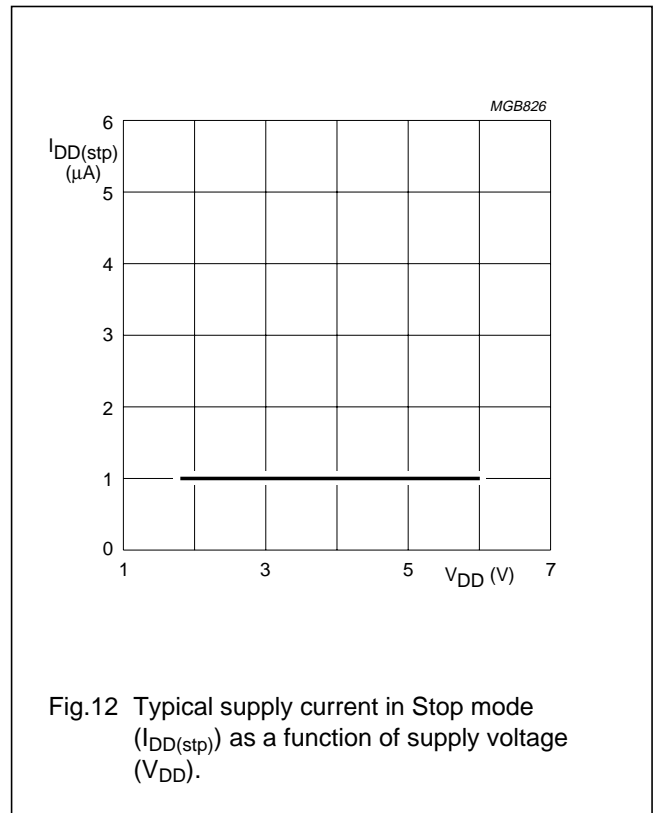
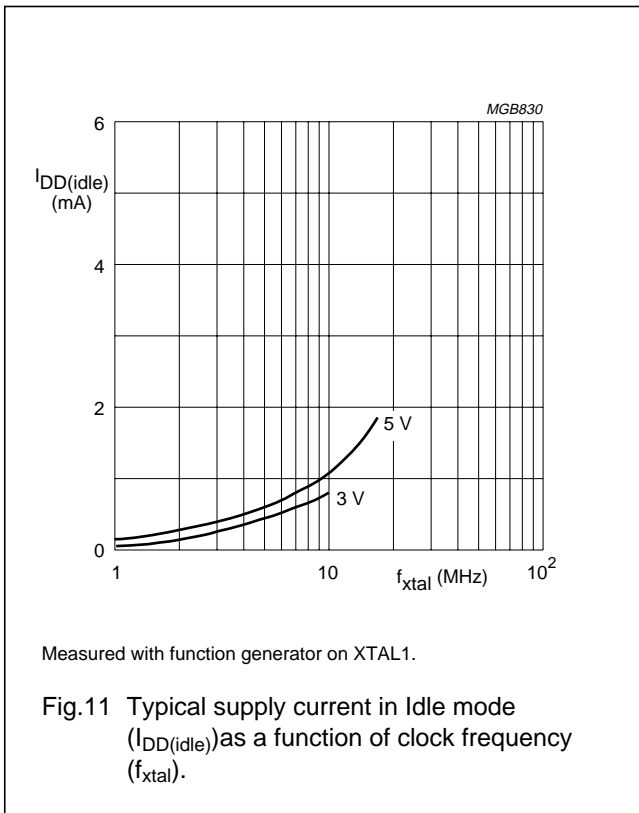

8-bit microcontroller with DTMF generator and 128 bytes EEPROM

PCD3359A

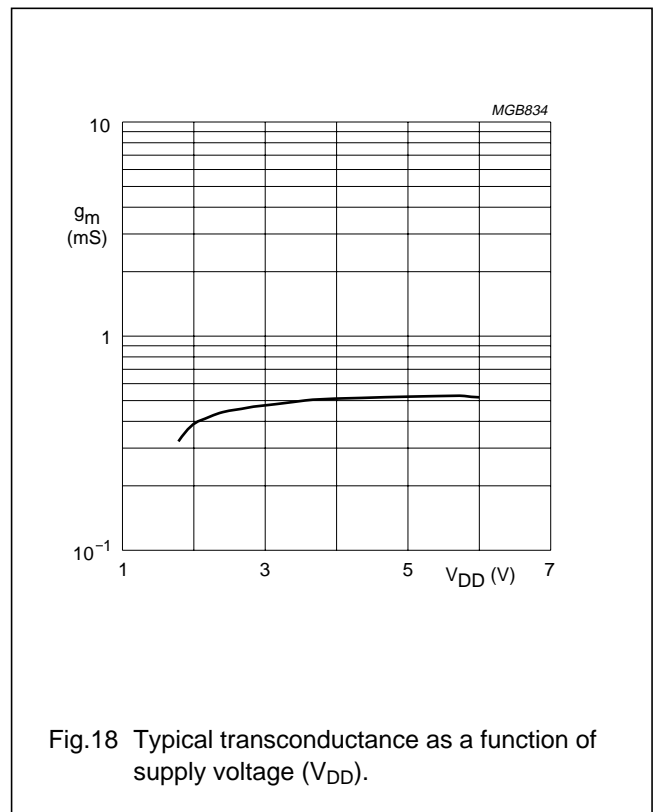
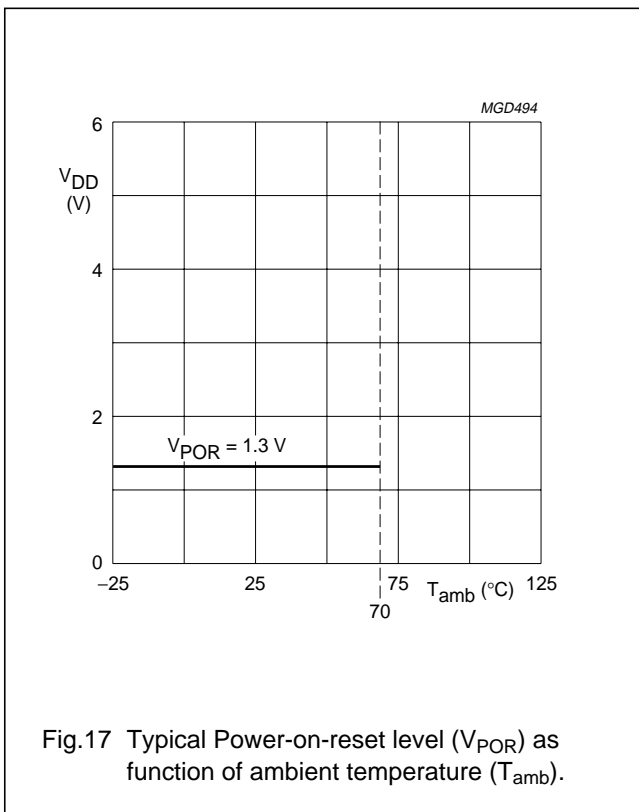
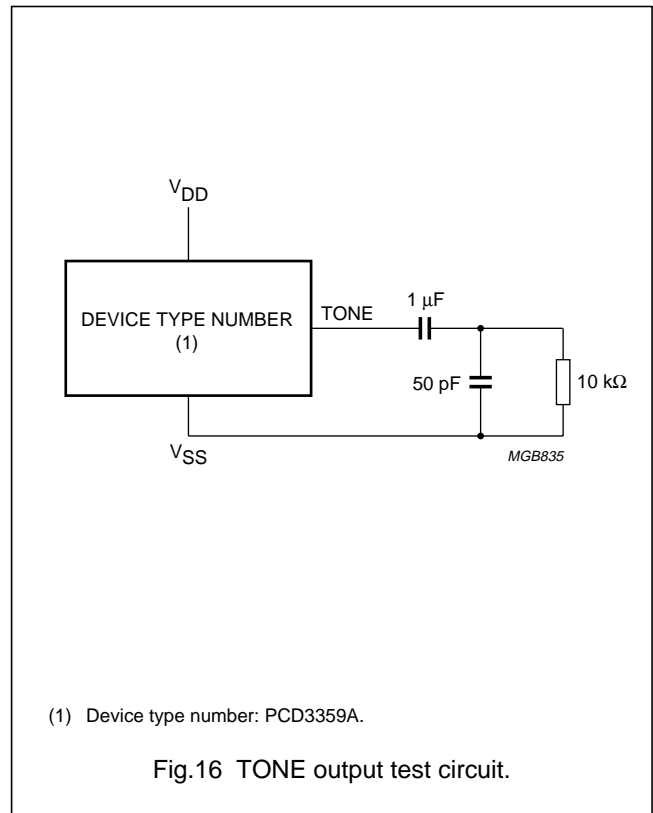
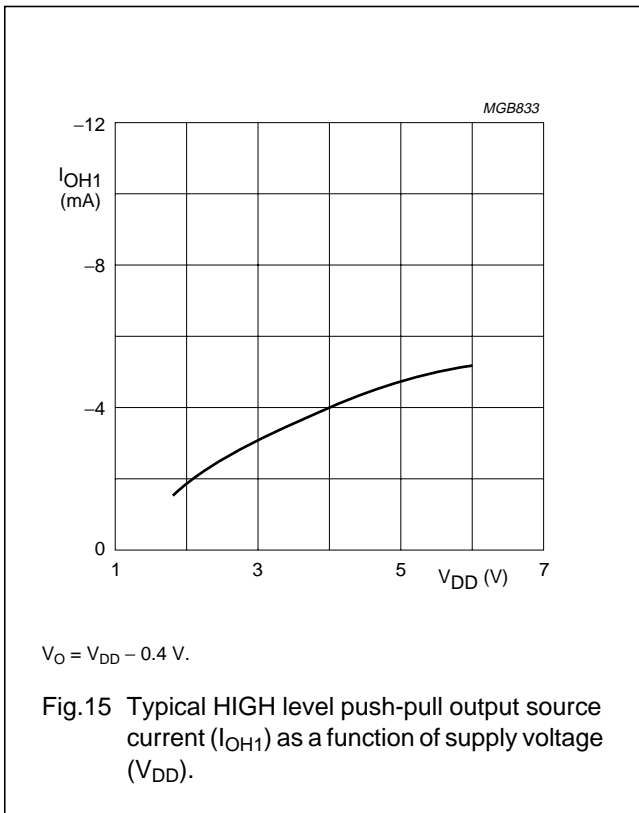

8-bit microcontroller with DTMF generator and 128 bytes EEPROM

PCD3359A

19 AC CHARACTERISTICS

$V_{DD} = 1.8$ to 6 V; $V_{SS} = 0$ V; $T_{amb} = -25$ to $+70$ °C; all voltages with respect to V_{SS} ; unless otherwise specified.

SYMBOL	PARAMETER	CONDITIONS	MIN.	TYP.	MAX.	UNIT
t_r	rise time all outputs	$V_{DD} = 5$ V; $T_{amb} = 25$ °C; $C_L = 50$ pF	–	30	–	ns
t_f	fall time all outputs		–	30	–	ns
f_{xtal}	clock frequency	see Fig.7	1	–	16	MHz

8-bit microcontroller with DTMF generator and 128 bytes EEPROM

PCD3359A

20 PACKAGE OUTLINES

DIP28: plastic dual in-line package; 28 leads (600 mil)

SOT117-1

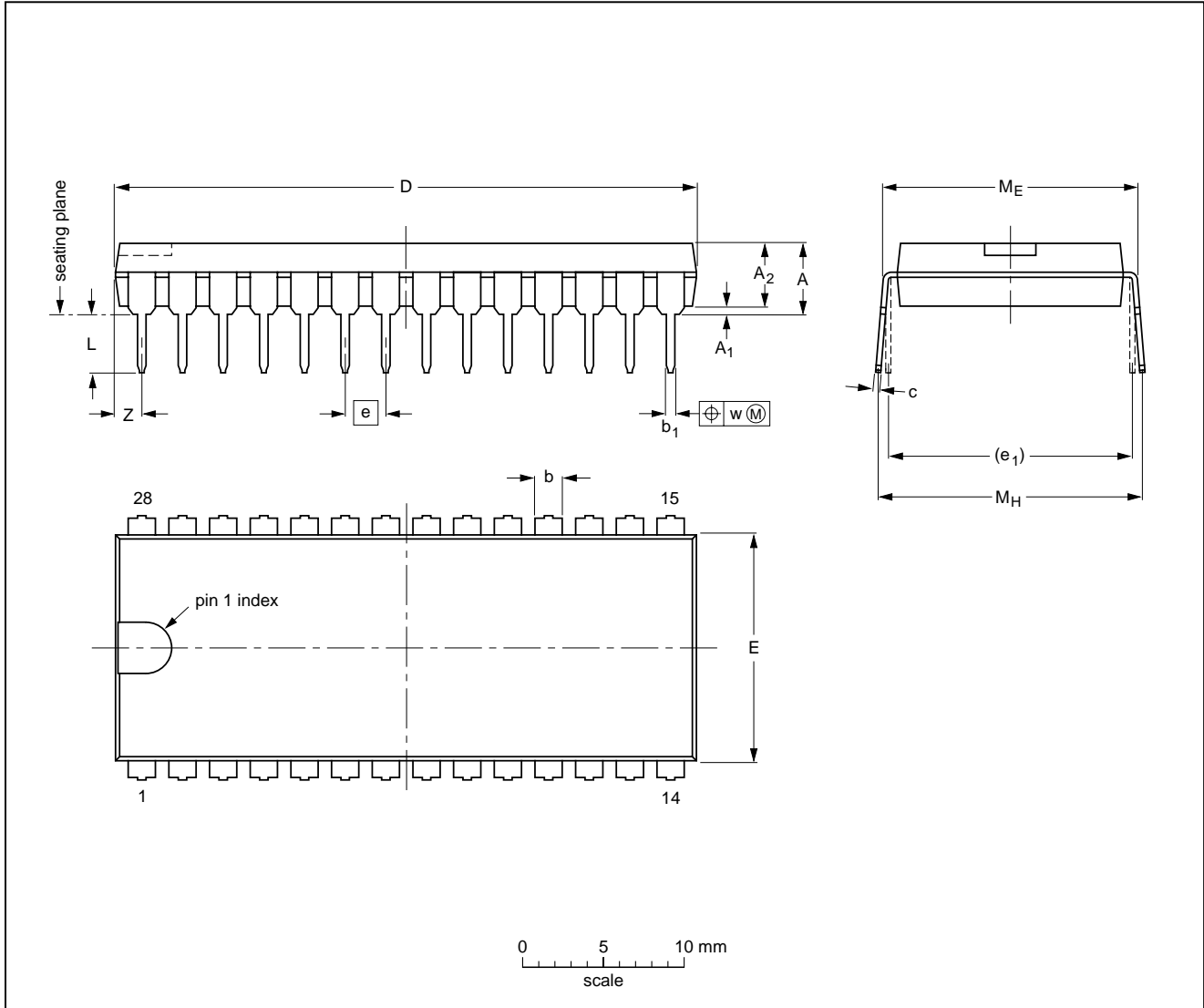

DIMENSIONS (inch dimensions are derived from the original mm dimensions)

UNIT	A max.	A ₁ min.	A ₂ max.	b	b ₁	c	D ⁽¹⁾	E ⁽¹⁾	e	e ₁	L	M _E	M _H	w	Z ⁽¹⁾ max.
mm	5.1	0.51	4.0	1.7 1.3	0.53 0.38	0.32 0.23	36.0 35.0	14.1 13.7	2.54	15.24	3.9 3.4	15.80 15.24	17.15 15.90	0.25	1.7
inches	0.20	0.020	0.16	0.066 0.051	0.020 0.014	0.013 0.009	1.41 1.34	0.56 0.54	0.10	0.60	0.15 0.13	0.62 0.60	0.68 0.63	0.01	0.067

Note

1. Plastic or metal protrusions of 0.25 mm maximum per side are not included.

OUTLINE VERSION	REFERENCES				EUROPEAN PROJECTION	ISSUE DATE
	IEC	JEDEC	EIAJ			
SOT117-1	051G05	MO-015AH				92-11-17 95-01-14

8-bit microcontroller with DTMF generator and 128 bytes EEPROM

PCD3359A

SO28: plastic small outline package; 28 leads; body width 7.5 mm

SOT136-1

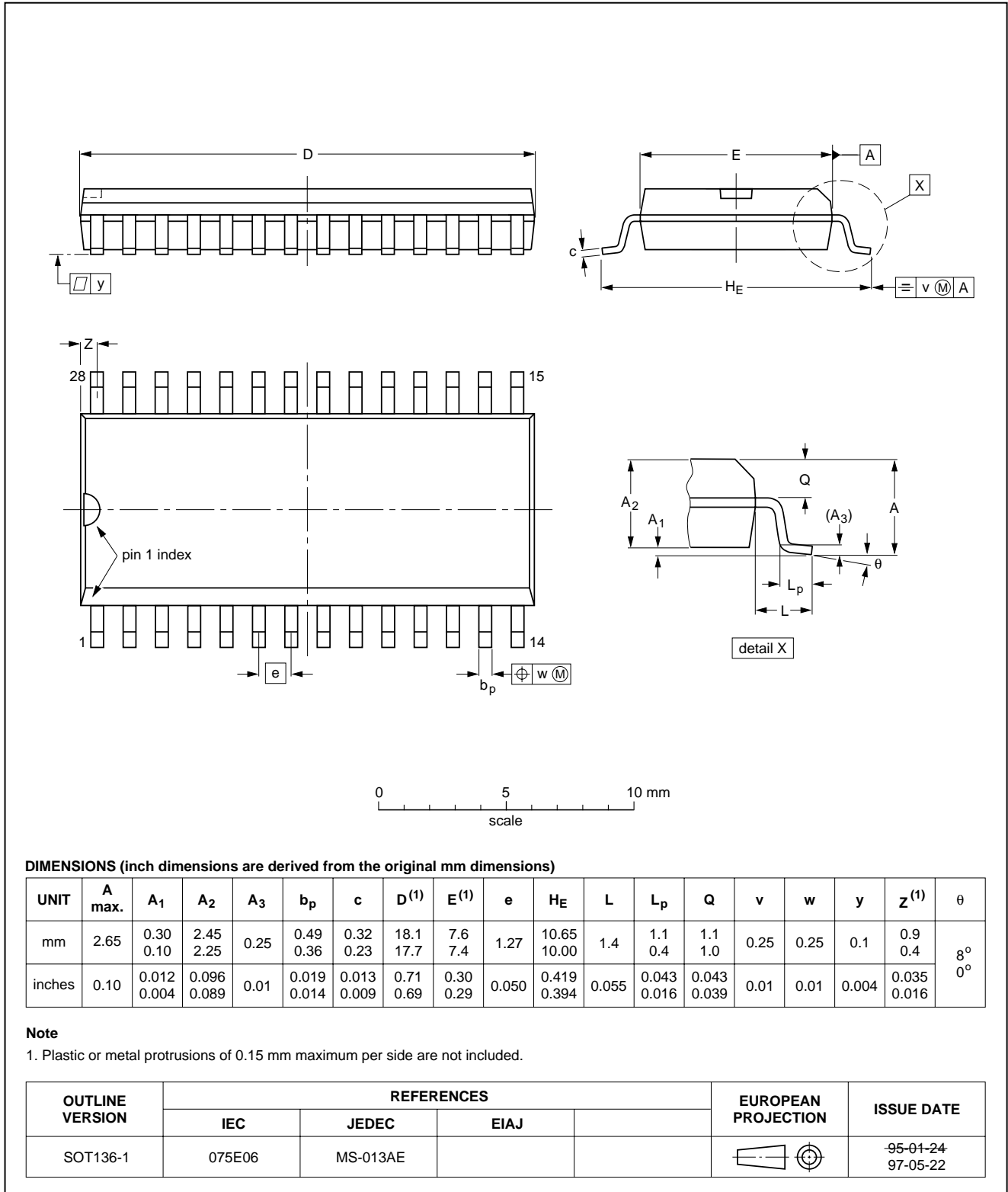

8-bit microcontroller with DTMF generator and 128 bytes EEPROM

PCD3359A

LQFP32: plastic low profile quad flat package; 32 leads; body 7 x 7 x 1.4 mm

SOT358-1

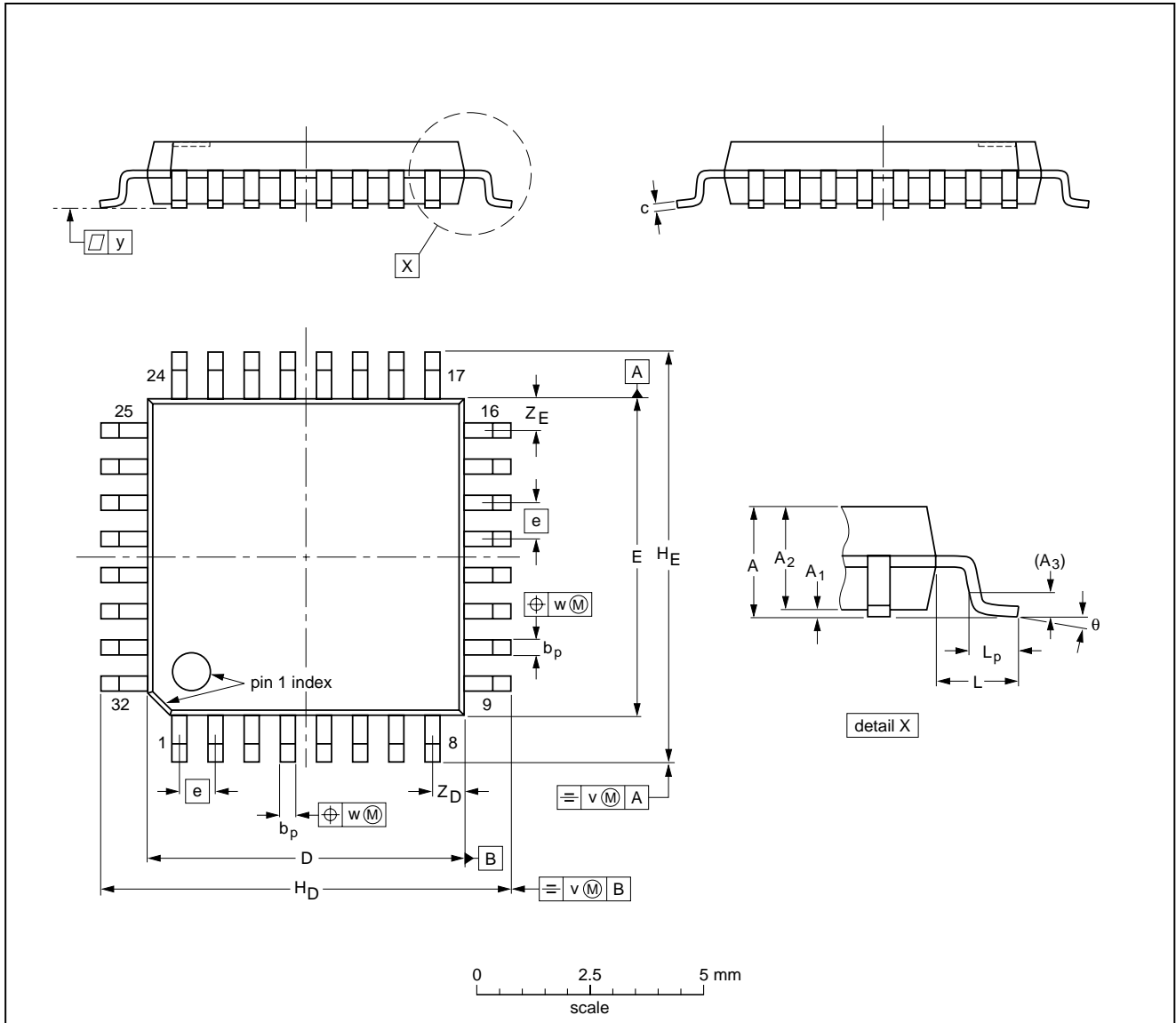

DIMENSIONS (mm are the original dimensions)

UNIT	A max.	A ₁	A ₂	A ₃	b _p	c	D ⁽¹⁾	E ⁽¹⁾	e	H _D	H _E	L	L _p	v	w	y	Z _D ⁽¹⁾	Z _E ⁽¹⁾	θ
mm	1.60	0.20 0.05	1.45 1.35	0.25	0.4 0.3	0.18 0.12	7.1 6.9	7.1 6.9	0.8	9.15 8.85	9.15 8.85	1.0	0.75 0.45	0.2	0.25	0.1	0.9 0.5	0.9 0.5	7° 0°

Note

1. Plastic or metal protrusions of 0.25 mm maximum per side are not included.

OUTLINE VERSION	REFERENCES			EUROPEAN PROJECTION	ISSUE DATE
	IEC	JEDEC	EIAJ		
SOT358 -1					95-12-19 97-08-04

8-bit microcontroller with DTMF generator and 128 bytes EEPROM

PCD3359A

21 SOLDERING

21.1 Introduction

There is no soldering method that is ideal for all IC packages. Wave soldering is often preferred when through-hole and surface mounted components are mixed on one printed-circuit board. However, wave soldering is not always suitable for surface mounted ICs, or for printed-circuits with high population densities. In these situations reflow soldering is often used.

This text gives a very brief insight to a complex technology. A more in-depth account of soldering ICs can be found in our "Data Handbook IC26; Integrated Circuit Packages" (order code 9398 652 90011).

21.2 DIP

21.2.1 SOLDERING BY DIPPING OR BY WAVE

The maximum permissible temperature of the solder is 260 °C; solder at this temperature must not be in contact with the joint for more than 5 seconds. The total contact time of successive solder waves must not exceed 5 seconds.

The device may be mounted up to the seating plane, but the temperature of the plastic body must not exceed the specified maximum storage temperature ($T_{stg\ max}$). If the printed-circuit board has been pre-heated, forced cooling may be necessary immediately after soldering to keep the temperature within the permissible limit.

21.2.2 REPAIRING SOLDERED JOINTS

Apply a low voltage soldering iron (less than 24 V) to the lead(s) of the package, below the seating plane or not more than 2 mm above it. If the temperature of the soldering iron bit is less than 300 °C it may remain in contact for up to 10 seconds. If the bit temperature is between 300 and 400 °C, contact may be up to 5 seconds.

21.3 LQFP and SO

21.3.1 REFLOW SOLDERING

Reflow soldering techniques are suitable for all LQFP and SO packages.

Reflow soldering requires solder paste (a suspension of fine solder particles, flux and binding agent) to be applied to the printed-circuit board by screen printing, stencilling or pressure-syringe dispensing before package placement.

Several methods exist for reflowing; for example, infrared/convection heating in a conveyor type oven. Throughput times (preheating, soldering and cooling) vary between 50 and 300 seconds depending on heating method. Typical reflow peak temperatures range from 215 to 250 °C.

21.3.2 WAVE SOLDERING

21.3.2.1 LQFP

Wave soldering is **not** recommended for LQFP packages. This is because of the likelihood of solder bridging due to closely-spaced leads and the possibility of incomplete solder penetration in multi-lead devices.

CAUTION
Wave soldering is NOT applicable for all LQFP packages with a pitch (e) equal or less than 0.5 mm.

If wave soldering cannot be avoided, for LQFP packages with a pitch (e) larger than 0.5 mm, the following conditions must be observed:

- **A double-wave (a turbulent wave with high upward pressure followed by a smooth laminar wave) soldering technique should be used.**
- **The footprint must be at an angle of 45° to the board direction and must incorporate solder thieves downstream and at the side corners.**

21.3.2.2 SO

Wave soldering techniques can be used for all SO packages if the following conditions are observed:

- A double-wave (a turbulent wave with high upward pressure followed by a smooth laminar wave) soldering technique should be used.
- The longitudinal axis of the package footprint must be parallel to the solder flow.
- The package footprint must incorporate solder thieves at the downstream end.

21.3.2.3 Method (LQFP and SO)

During placement and before soldering, the package must be fixed with a droplet of adhesive. The adhesive can be applied by screen printing, pin transfer or syringe dispensing. The package can be soldered after the adhesive is cured.

8-bit microcontroller with DTMF generator and 128 bytes EEPROM

PCD3359A

Maximum permissible solder temperature is 260 °C, and maximum duration of package immersion in solder is 10 seconds, if cooled to less than 150 °C within 6 seconds. Typical dwell time is 4 seconds at 250 °C.

A mildly-activated flux will eliminate the need for removal of corrosive residues in most applications.

21.3.3 REPAIRING SOLDERED JOINTS

Fix the component by first soldering two diagonally-opposite end leads. Use only a low voltage soldering iron (less than 24 V) applied to the flat part of the lead. Contact time must be limited to 10 seconds at up to 300 °C. When using a dedicated tool, all other leads can be soldered in one operation within 2 to 5 seconds between 270 and 320 °C.

22 DEFINITIONS

Data sheet status	
Objective specification	This data sheet contains target or goal specifications for product development.
Preliminary specification	This data sheet contains preliminary data; supplementary data may be published later.
Product specification	This data sheet contains final product specifications.
Limiting values	
Limiting values given are in accordance with the Absolute Maximum Rating System (IEC 134). Stress above one or more of the limiting values may cause permanent damage to the device. These are stress ratings only and operation of the device at these or at any other conditions above those given in the Characteristics sections of the specification is not implied. Exposure to limiting values for extended periods may affect device reliability.	
Application information	
Where application information is given, it is advisory and does not form part of the specification.	

23 LIFE SUPPORT APPLICATIONS

These products are not designed for use in life support appliances, devices, or systems where malfunction of these products can reasonably be expected to result in personal injury. Philips customers using or selling these products for use in such applications do so at their own risk and agree to fully indemnify Philips for any damages resulting from such improper use or sale.

Philips Semiconductors – a worldwide company

Argentina: see South America

Australia: 34 Waterloo Road, NORTH RYDE, NSW 2113,
Tel. +61 2 9805 4455, Fax. +61 2 9805 4466

Austria: Computerstr. 6, A-1101 WIEN, P.O. Box 213, Tel. +43 160 1010,
Fax. +43 160 101 1210

Belarus: Hotel Minsk Business Center, Bld. 3, r. 1211, Volodarski Str. 6,
220050 MINSK, Tel. +375 172 200 733, Fax. +375 172 200 773

Belgium: see The Netherlands

Brazil: see South America

Bulgaria: Philips Bulgaria Ltd., Energoproject, 15th floor,
51 James Bourchier Blvd., 1407 SOFIA,
Tel. +359 2 689 211, Fax. +359 2 689 102

Canada: PHILIPS SEMICONDUCTORS/COMPONENTS,
Tel. +1 800 234 7381

China/Hong Kong: 501 Hong Kong Industrial Technology Centre,
72 Tat Chee Avenue, Kowloon Tong, HONG KONG,
Tel. +852 2319 7888, Fax. +852 2319 7700

Colombia: see South America

Czech Republic: see Austria

Denmark: Prags Boulevard 80, PB 1919, DK-2300 COPENHAGEN S,
Tel. +45 32 88 2636, Fax. +45 31 57 0044

Finland: Sinikalliontie 3, FIN-02630 ESPOO,
Tel. +358 9 615800, Fax. +358 9 61580920

France: 51 Rue Carnot, BP317, 92156 SURESNES Cedex,
Tel. +33 1 40 99 6161, Fax. +33 1 40 99 6427

Germany: Hammerbrookstraße 69, D-20097 HAMBURG,
Tel. +49 40 23 53 60, Fax. +49 40 23 536 300

Greece: No. 15, 25th March Street, GR 17778 TAVROS/ATHENS,
Tel. +30 1 4894 339/239, Fax. +30 1 4814 240

Hungary: see Austria

India: Philips INDIA Ltd, Band Box Building, 2nd floor,
254-D, Dr. Annie Besant Road, Worli, MUMBAI 400 025,
Tel. +91 22 493 8541, Fax. +91 22 493 0966

Indonesia: PT Philips Development Corporation, Semiconductors Division,
Gedung Philips, Jl. Buncit Raya Kav.99-100, JAKARTA 12510,
Tel. +62 21 794 0040 ext. 2501, Fax. +62 21 794 0080

Ireland: Newstead, Clonskeagh, DUBLIN 14,
Tel. +353 1 7640 000, Fax. +353 1 7640 200

Israel: RAPAC Electronics, 7 Kehilat Saloniki St, PO Box 18053,
TEL AVIV 61180, Tel. +972 3 645 0444, Fax. +972 3 649 1007

Italy: PHILIPS SEMICONDUCTORS, Piazza IV Novembre 3,
20124 MILANO, Tel. +39 2 6752 2531, Fax. +39 2 6752 2557

Japan: Philips Bldg 13-37, Kohnan 2-chome, Minato-ku,
TOKYO 108-8507, Tel. +81 3 3740 5130, Fax. +81 3 3740 5077

Korea: Philips House, 260-199 Itaewon-dong, Yongsan-ku, SEOUL,
Tel. +82 2 709 1412, Fax. +82 2 709 1415

Malaysia: No. 76 Jalan Universiti, 46200 PETALING JAYA, SELANGOR,
Tel. +60 3 750 5214, Fax. +60 3 757 4880

Mexico: 5900 Gateway East, Suite 200, EL PASO, TEXAS 79905,
Tel. +9-5 800 234 7381

Middle East: see Italy

Netherlands: Postbus 90050, 5600 PB EINDHOVEN, Bldg. VB,
Tel. +31 40 27 82785, Fax. +31 40 27 88399

New Zealand: 2 Wagener Place, C.P.O. Box 1041, AUCKLAND,
Tel. +64 9 849 4160, Fax. +64 9 849 7811

Norway: Box 1, Manglerud 0612, OSLO,
Tel. +47 22 74 8000, Fax. +47 22 74 8341

Pakistan: see Singapore

Philippines: Philips Semiconductors Philippines Inc.,
106 Valero St. Salcedo Village, P.O. Box 2108 MCC, MAKATI,
Metro MANILA, Tel. +63 2 816 6380, Fax. +63 2 817 3474

Poland: Ul. Lukiska 10, PL 04-123 WARSZAWA,
Tel. +48 22 612 2831, Fax. +48 22 612 2327

Portugal: see Spain

Romania: see Italy

Russia: Philips Russia, Ul. Usatcheva 35A, 119048 MOSCOW,
Tel. +7 095 755 6918, Fax. +7 095 755 6919

Singapore: Lorong 1, Toa Payoh, SINGAPORE 319762,
Tel. +65 350 2538, Fax. +65 251 6500

Slovakia: see Austria

Slovenia: see Italy

South Africa: S.A. PHILIPS Pty Ltd., 195-215 Main Road Martindale,
2092 JOHANNESBURG, P.O. Box 7430 Johannesburg 2000,
Tel. +27 11 470 5911, Fax. +27 11 470 5494

South America: Al. Vicente Pinzon, 173, 6th floor,
04547-130 SÃO PAULO, SP, Brazil,
Tel. +55 11 821 2333, Fax. +55 11 821 2382

Spain: Balmes 22, 08007 BARCELONA,
Tel. +34 93 301 6312, Fax. +34 93 301 4107

Sweden: Kottbygatan 7, Akalla, S-16485 STOCKHOLM,
Tel. +46 8 5985 2000, Fax. +46 8 5985 2745

Switzerland: Allmendstrasse 140, CH-8027 ZÜRICH,
Tel. +41 1 488 2741 Fax. +41 1 488 3263

Taiwan: Philips Semiconductors, 6F, No. 96, Chien Kuo N. Rd., Sec. 1,
TAIPEI, Taiwan Tel. +886 2 2134 2865, Fax. +886 2 2134 2874

Thailand: PHILIPS ELECTRONICS (THAILAND) Ltd.,
209/2 Sanpavuth-Bangna Road Prakanong, BANGKOK 10260,
Tel. +66 2 745 4090, Fax. +66 2 398 0793

Turkey: Talatpasa Cad. No. 5, 80640 GÜLTEPE/ISTANBUL,
Tel. +90 212 279 2770, Fax. +90 212 282 6707

Ukraine: PHILIPS UKRAINE, 4 Patrice Lumumba str., Building B, Floor 7,
252042 KIEV, Tel. +380 44 264 2776, Fax. +380 44 268 0461

United Kingdom: Philips Semiconductors Ltd., 276 Bath Road, Hayes,
MIDDLESEX UB3 5BX, Tel. +44 181 730 5000, Fax. +44 181 754 8421

United States: 811 East Arques Avenue, SUNNYVALE, CA 94088-3409,
Tel. +1 800 234 7381

Uruguay: see South America

Vietnam: see Singapore

Yugoslavia: PHILIPS, Trg N. Pasica 5/v, 11000 BEOGRAD,
Tel. +381 11 625 344, Fax. +381 11 635 777

For all other countries apply to: Philips Semiconductors,
International Marketing & Sales Communications, Building BE-p, P.O. Box 218,
5600 MD EINDHOVEN, The Netherlands, Fax. +31 40 27 24825

Internet: <http://www.semiconductors.philips.com>

© Philips Electronics N.V. 1998

SCA60

All rights are reserved. Reproduction in whole or in part is prohibited without the prior written consent of the copyright owner.

The information presented in this document does not form part of any quotation or contract, is believed to be accurate and reliable and may be changed without notice. No liability will be accepted by the publisher for any consequence of its use. Publication thereof does not convey nor imply any license under patent- or other industrial or intellectual property rights.

Printed in The Netherlands

415102/1200/04/pp32

Date of release: 1998 May 11

Document order number: 9397 750 03731

Let's make things better.

Philips
Semiconductors



PHILIPS