

# DATA SHEET

## **PCF2104x** LCD controller/driver

Product specification  
Supersedes data of 1997 Apr 01  
File under Integrated Circuits, IC12

1997 Dec 16

## LCD controller/driver

## PCF2104x

<b>CONTENTS</b>			
1	FEATURES	9.4	Display on/off control
2	APPLICATIONS	9.4.1	D
3	GENERAL DESCRIPTION	9.4.2	C
3.1	Packages	9.4.3	B
3.2	Available types	9.5	Cursor/display shift
4	ORDERING INFORMATION	9.6	Function set
5	BLOCK DIAGRAM	9.6.1	DL (parallel mode only)
6	PINNING	9.6.2	N, M
7	PIN FUNCTIONS	9.7	Set CGRAM address
7.1	RS: register select (parallel control)	9.8	Set DDRAM address
7.2	R/W: read/write (parallel control)	9.9	Read busy flag and address
7.3	E: data bus clock (parallel control)	9.10	Write data to CGRAM or DDRAM
7.4	DB0 to DB7: data bus (parallel control)	9.11	Read data from CGRAM or DDRAM
7.5	C1 to C60: column driver outputs	10	INTERFACE TO MICROCONTROLLER (PARALLEL INTERFACE)
7.6	R1 to R32: row driver outputs	11	INTERFACE TO MICROCONTROLLER (I <sup>2</sup> C-BUS INTERFACE)
7.7	VLCD: LCD power supply	11.1	Characteristics of the I <sup>2</sup> C-bus
7.8	OSC: oscillator	11.2	Bit transfer
7.9	SCL: serial clock line	11.3	Start and stop conditions
7.10	SDA: serial data line	11.4	System configuration
7.11	SA0: address pin	11.5	Acknowledge
7.12	T1: test pad	11.6	I <sup>2</sup> C-bus protocol
8	FUNCTIONAL DESCRIPTION	12	LIMITING VALUES
8.1	LCD bias voltage generator	13	HANDLING
8.2	Oscillator	14	DC CHARACTERISTICS
8.3	External clock	15	AC CHARACTERISTICS
8.4	Power-on reset	16	TIMING DIAGRAMS
8.5	Registers	17	APPLICATION INFORMATION
8.6	Busy Flag	17.1	8-bit operation, 2 × 12 display using internal reset
8.7	Address Counter (AC)	17.2	4-bit operation, 2 × 12 display using internal reset
8.8	Display data RAM (DDRAM)	17.3	8-bit operation, 2 × 24 display
8.9	Character generator ROM (CGROM)	17.4	I <sup>2</sup> C operation, 2 × 12 display
8.10	Character generator RAM (CGRAM)	17.5	Initializing by instruction
8.11	Cursor control circuit	18	BONDING PAD LOCATIONS
8.12	Timing generator	19	DEFINITIONS
8.13	LCD row and column drivers	20	LIFE SUPPORT APPLICATIONS
8.14	Programming of MUX 1 : 16 displays with PCF2104x	21	PURCHASE OF PHILIPS I <sup>2</sup> C COMPONENTS
8.15	Programming of MUX 1 : 32 displays with PCF2104x		
8.16	Reset function		
9	INSTRUCTIONS		
9.1	Clear display		
9.2	Return home		
9.3	Entry mode set		
9.3.1	I/D		
9.3.2	S		



## LCD controller/driver

## PCF2104x

**1 FEATURES**

- Single chip LCD controller/driver
- 1 or 2-line display of up to 24 characters per line, or 2 or 4 lines of up to 12 characters per line
- 5 × 7 character format plus cursor; 5 × 8 for kana (Japanese syllabary) and user-defined symbols
- On-chip:
  - generation of intermediate LCD bias voltages
  - oscillator requires no external components (external clock also possible)
- Display data RAM: 80 characters
- Character generator ROM: 240 characters
- Character generator RAM: 16 characters
- 4 or 8-bit parallel bus or 2-wire I<sup>2</sup>C-bus interface
- CMOS/TTL compatible
- 32 row, 60 column outputs
- MUX rates 1 : 32 and 1 : 16
- Uses common 11 code instruction set
- Logic supply voltage range, V<sub>DD</sub> – V<sub>SS</sub>: 2.5 to 6 V
- Display supply voltage range, V<sub>DD</sub> – V<sub>LCD</sub>: 3.5 to 9 V
- Low power consumption.
- I<sup>2</sup>C-bus address: 011101 SA0.

**2 APPLICATIONS**

- Telecom equipment
- Portable instruments
- Point-of-sale terminals.

**3 GENERAL DESCRIPTION**

The PCF2104x integrated circuit is similar to the PCF2114x (described in the “PCF2116 family” data sheet)

**4 ORDERING INFORMATION**

TYPE NUMBER	PACKAGE		
	NAME	DESCRIPTION	VERSION
PCF2104CU/2	–	chip with bumps in tray	–
PCF2104CU/7	–	chip with bumps on tape	–
PCF2104LU/2	–	chip with bumps in tray	–
PCF2104LU/7	–	chip with bumps on tape	–
PCF2104NU/2	–	chip with bumps in tray	–
PCF2104NU/7	–	chip with bumps on tape	–

but does not contain the high voltage generator of that device.

The PCF2104x is optimized for chip-on-glass applications. The ‘x’ in ‘PCF2104x’ represents a specific letter code for a character set in the character generator ROM (CGROM).

Two standard character sets are currently available, specified by the letters ‘C’ and ‘L’ (see Figs 5 and 6). Other character sets are available on request.

The PCF2104x is a low-power CMOS LCD controller and driver, designed to drive a split screen dot matrix LCD display of 1 or 2 lines by 24 characters or 2 or 4 lines by 12 characters with a 5 × 8 dot format. All necessary functions for the display are provided in a single chip, including on-chip generation of LCD bias voltages which results in a minimum of external components and lower system power consumption. To allow partial V<sub>DD</sub> shutdown the ESD protection system of the SCL and SDA pins does not use a diode connected to V<sub>DD</sub>.

The chip contains a character generator and displays alphanumeric and kana characters. The PCF2104x interfaces to most microcontrollers via a 4 or 8-bit bus, or via the 2-wire I<sup>2</sup>C-bus.

**3.1 Packages**

- PCF2104xU/2; chip with bumps in tray
- PCF2104xU/7; chip with bumps on tape.

For further details see Chapter 18.

**3.2 Available types**

- PCF2104CU/x: character set ‘C’ in CGROM
- PCF2104LU/x: character set ‘L’ in CGROM
- PCF2104NU/x: character set ‘N’ in CGROM.

LCD controller/driver

PCF2104x

5 BLOCK DIAGRAM

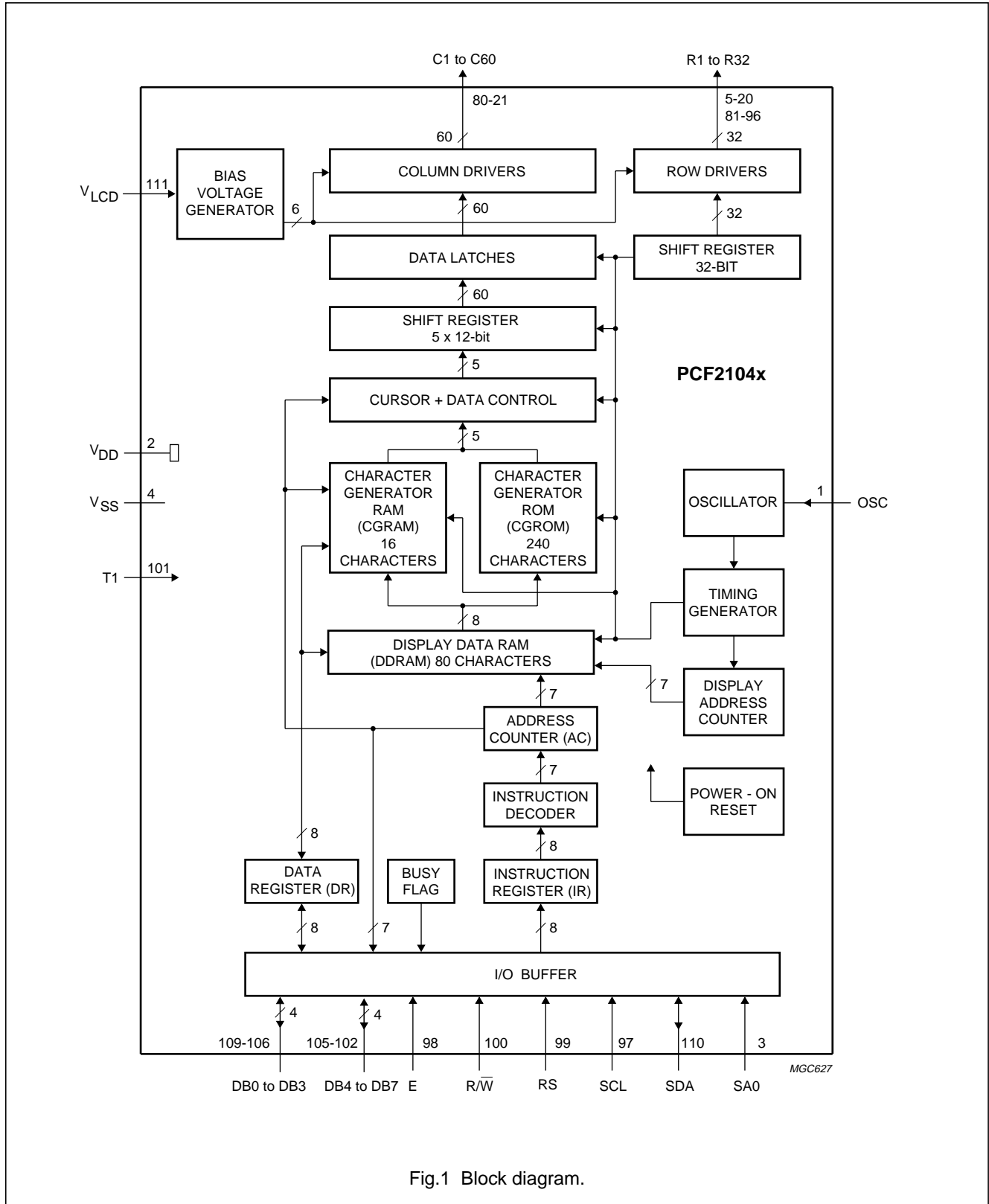

Fig.1 Block diagram.

## LCD controller/driver

## PCF2104x

## 6 PINNING

SYMBOL	FFC PAD	TYPE	DESCRIPTION
OSC	1	I	oscillator/external clock input
V <sub>DD</sub>	2	P	logic supply voltage
SA0	3	I	I <sup>2</sup> C-bus address pin input
V <sub>SS</sub>	4	P	ground
R8 to R5	5 to 8	O	LCD row driver outputs
R32 to R29	9 to 12	O	LCD row driver outputs
R24 to R17	13 to 20	O	LCD row driver outputs
C60 to C1	21 to 80	O	LCD column driver outputs
R9 to R16	81 to 88	O	LCD row driver outputs
R25 to R28	89 to 92	O	LCD row driver outputs
R1 to R4	93 to 96	O	LCD row driver outputs
SCL	97	I	I <sup>2</sup> C-bus serial clock input
E	98	I	data bus clock input
RS	99	I	register select input
R/ $\bar{W}$	100	I	read/write input
T1	101	I	test pad input
DB7 to DB0	102 to 109	I/O	8-bit bidirectional data bus input/output
SDA	110	I/O	I <sup>2</sup> C-bus serial data input/output
V <sub>LCD</sub>	111	I	LCD supply voltage input

## 7 PIN FUNCTIONS

## 7.1 RS: register select (parallel control)

RS selects the register to be accessed for read and write when the device is controlled by the parallel interface.

RS = logic 0 selects the instruction register for write and the Busy Flag and Address Counter for read. RS = logic 1 selects the data register for both read and write. There is an internal pull-up on pin RS.

7.2 R/ $\bar{W}$ : read/write (parallel control)

R/ $\bar{W}$  selects either the read (R/ $\bar{W}$  = logic 1) or write (R/ $\bar{W}$  = logic 0) operation when control is by the parallel interface. There is an internal pull-up on this pin.

## 7.3 E: data bus clock (parallel control)

The E pin is set HIGH to signal the start of a read or write operation when the device is controlled by the parallel interface. Data is clocked in or out of the chip on the negative edge of the clock. Note that this pin must be tied to logic 0 (V<sub>SS</sub>) when I<sup>2</sup>C-bus control is used.

## 7.4 DB0 to DB7: data bus (parallel control)

The bidirectional, 3-state data bus transfers data between the system controller and the PCF2104x. DB7 may be used as the Busy Flag, signalling that internal operations are not yet completed. In 4-bit operations the 4 higher order lines DB4 to DB7 are used; DB0 to DB3 must be left open circuit. There is an internal pull-up on each of the data lines. Note that these pins must be left open circuit when I<sup>2</sup>C-bus control is used.

## 7.5 C1 to C60: column driver outputs

These pins output the data for pairs of columns. This arrangement permits optimized chip-on-glass (COG) layout for 4-line by 12 characters.

## 7.6 R1 to R32: row driver outputs

These pins output the row select waveforms to the left and right halves of the display.

7.7 V<sub>LCD</sub>: LCD power supply

Negative power supply for the liquid crystal display.

## LCD controller/driver

## PCF2104x

**7.8 OSC: oscillator**

When the on-chip oscillator is used, this pin must be connected to  $V_{DD}$ . An external clock signal, if used, is input at this pin.

**7.9 SCL: serial clock line**

Input for the I<sup>2</sup>C-bus clock signal.

**7.10 SDA: serial data line**

Input/output for the I<sup>2</sup>C-bus data line.

**7.11 SA0: address pin**

The hardware sub-address line is used to program the device sub-address for 2 different PCF2104xs on the same I<sup>2</sup>C-bus.

**7.12 T1: test pad**

Must be connected to  $V_{SS}$ . Not user accessible.

**8 FUNCTIONAL DESCRIPTION** (see Fig.1)**8.1 LCD bias voltage generator**

The intermediate bias voltages for the LCD display are also generated on-chip. This removes the need for an external resistive bias chain and significantly reduces the system power consumption. The optimum levels depend on the multiplex rate and are selected automatically when the number of lines in the display is defined.

The optimum value of  $V_{OP}$  depends on the multiplex rate, the LCD threshold voltage ( $V_{th}$ ) and the number of bias levels. The relationships are given in Table 1.

Using a 5-level bias scheme for 1 : 16 MUX rate allows  $V_{OP} < 5$  V for most LCD liquids. The effect on the display contrast is negligible.

**Table 1** Optimum values for  $V_{OP}$

MUX RATE	NUMBER OF BIAS LEVELS	$V_{OP}/V_{th}$	DISCRIMINATION $V_{on}/V_{off}$
1 : 16	5	3.67	1.277
1 : 32	6	5.19	1.196

**8.2 Oscillator**

The on-chip oscillator provides the clock signal for the display system. No external components are required. Pin OSC must be connected to  $V_{DD}$ .

**8.3 External clock**

If an external clock is to be used, it must be input at pin OSC. The resulting display frame frequency is given by  $f_{frame} = \frac{1}{2} \cdot 304 \cdot f_{osc}$ . A clock signal must always be present, otherwise the LCD may be frozen in a DC state.

**8.4 Power-on reset**

The Power-on reset block initializes the chip after power-on or power failure.

**8.5 Registers**

The PCF2104x has two 8-bit registers, an instruction register (IR) and a data register (DR). The register select signal (RS) determines which register will be accessed.

The instruction register stores instruction codes such as display clear and cursor shift, and address information for the Display Data RAM (DDRAM) and Character Generator RAM (CGRAM). The instruction register can be written to, but not read from, by the system controller.

The data register temporarily stores data to be read from the DDRAM and CGRAM. When reading, data from the DDRAM or CGRAM (corresponding to the address in the Address Counter) is written to the data register prior to being read by the 'Read data' instruction.

**8.6 Busy Flag**

The Busy Flag indicates the free/busy status of the PCF2104x. Logic 1 indicates that the chip is busy and further instructions will not be accepted. The Busy Flag is output at pin DB7 when RS = logic 0 and  $R/\bar{W}$  = logic 1. Instructions should only be written after checking that the Busy Flag is at logic 0 or waiting for the required number of clock cycles.

---

**LCD controller/driver****PCF2104x**

---

**8.7 Address Counter (AC)**

The Address Counter assigns addresses to the DDRAM and CGRAM for reading and writing and is set by the instructions 'Set CGRAM address' and 'Set DDRAM address'. After a read/write operation the Address Counter is automatically incremented or decremented by 1. The Address Counter contents are output to the bus (DB0 to DB6) when RS = logic 0 and  $R/\overline{W}$  = logic 1.

**8.8 Display data RAM (DDRAM)**

The DDRAM stores up to 80 characters of display data, represented by 8-bit character codes. DDRAM locations not used for storing display data can be used as general purpose RAM. The basic DDRAM-to-display mapping scheme is shown in Fig.2. With no display shift, the characters represented by the codes in the first 12 or 24 RAM locations, starting at address 00 in line 1, are displayed. Subsequent lines display data starting at addresses 20, 40, or 60 Hex. Figures 3 and 4 show the DDRAM-to-display mapping scheme when the display is shifted.

The address range for a 1-line display is 00 to 4F; for a 2-line display from 00 to 27 (line 1) and 40 to 67 (line 2); for a 4-line display from 00 to 13, 20 to 33, 40 to 53 and 60 to 73 for lines 1, 2, 3 and 4 respectively. For 2 and 4-line displays the end address of one line and the start address of the next line are not consecutive. When the display is shifted each line wraps around independently of the others (see Figs 3 and 4).

When data is written to the DDRAM wrap-around occurs from 4F to 00 in 1-line mode and from 27 to 40 and 67 to 00 in 2-line mode; from 13 to 20, 33 to 40, 53 to 60 and 73 to 00 in 4-line mode.

**8.9 Character generator ROM (CGROM)**

The character generator ROM generates 240 character patterns in  $5 \times 8$  dot format from 8-bit character codes. Figures 5 and 6 show the character sets currently available.

**8.10 Character generator RAM (CGRAM)**

Up to 16 user-defined characters may be stored in the character generator RAM. The CGROM and CGRAM use a common address space, of which the first column is reserved for the CGRAM (see Fig.5). Figure 8 shows the addressing principle for the CGRAM.

**8.11 Cursor control circuit**

The cursor control circuit generates the cursor (underline and/or character blink as shown in Fig.9) at the DDRAM address contained in the Address Counter. When the Address Counter contains the CGRAM address the cursor will be inhibited.

**8.12 Timing generator**

The timing generator produces the various signals required to drive the internal circuitry. Internal chip operation is not disturbed by operations on the data buses.

**8.13 LCD row and column drivers**

The PCF2104x contains 32 row and 60 column drivers, which connect the appropriate LCD bias voltages in sequence to the display, in accordance with the data to be displayed. The bias voltages and the timing are selected automatically when the number of lines in the display is selected. Figures 10 and 11 show typical waveforms.

In the 1-line mode (1 : 16) the row outputs are driven in pairs: R1/R17, R2/R18 for example. This allows the output pairs to be connected in parallel, thereby providing greater drive capability.

Unused outputs should be left unconnected.

LCD controller/driver

PCF2104x

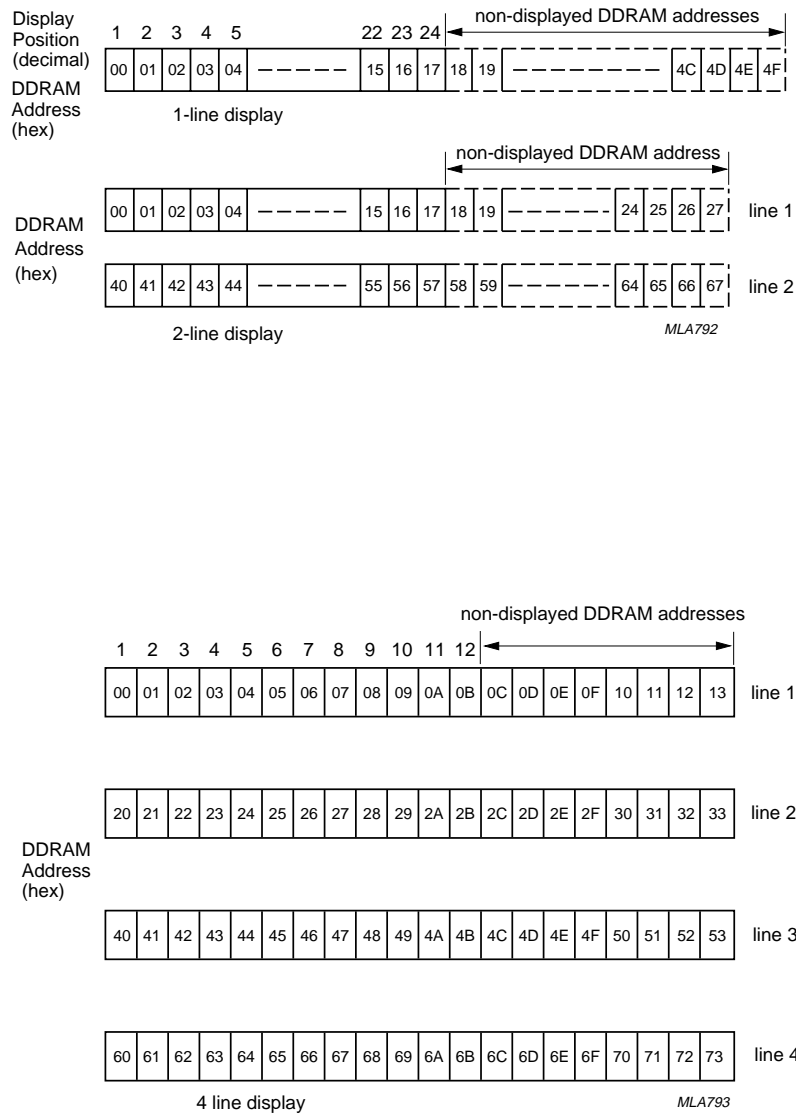

Fig.2 DDRAM-to-display mapping; no shift (PCF2104x).



LCD controller/driver

PCF2104x

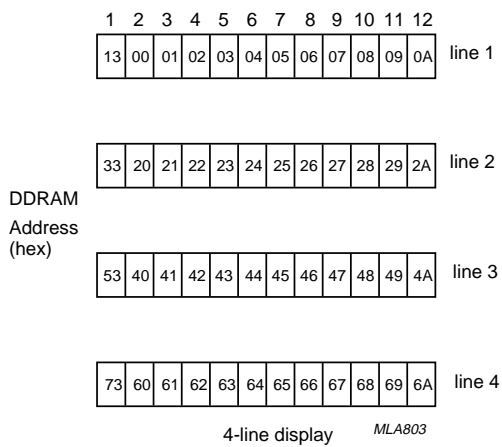
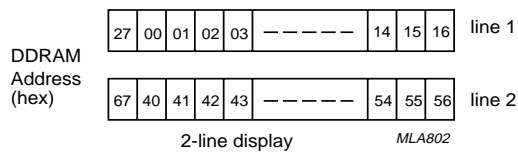
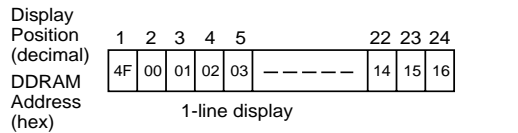

Fig.3 DDRAM-to-display mapping; right shift (PCF2104x).

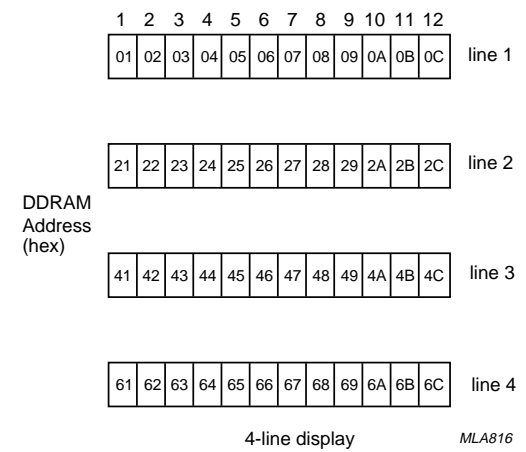
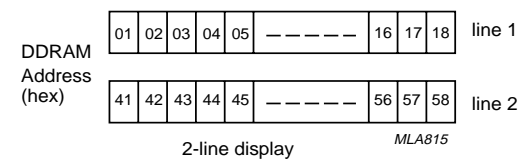
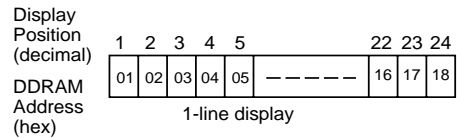

Fig.4 DDRAM-to-display mapping; left shift (PCF2104x).

LCD controller/driver

PCF2104x

















































































































































































































































upper lower 4 bits 4 bits	0000	0001	0010	0011	0100	0101	0110	0111	1000	1001	1010	1011	1100	1101	1110	1111
xxxx 0000	CG RAM 1															
xxxx 0001	2															
xxxx 0010	3															
xxxx 0011	4															
xxxx 0100	5															
xxxx 0101	6															
xxxx 0110	7															
xxxx 0111	8															
xxxx 1000	9															
xxxx 1001	10															
xxxx 1010	11															
xxxx 1011	12															
xxxx 1100	13															
xxxx 1101	14															
xxxx 1110	15															
xxxx 1111	16															

MLB895

Fig.5 Character set 'C' in CGROM; PCF2104C.

LCD controller/driver

PCF2104x

upper 4 bits lower 6 bits	0000	0001	0010	0011	0100	0101	0110	0111	1000	1001	1010	1011	1100	1101	1110	1111
xxxx 0000	CG RAM 1															
xxxx 0001	2															
xxxx 0010	3															
xxxx 0011	4															
xxxx 0100	5															
xxxx 0101	6															
xxxx 0110	7															
xxxx 0111	8															
xxxx 1000	9															
xxxx 1001	10															
xxxx 1010	11															
xxxx 1011	12															
xxxx 1100	13															
xxxx 1101	14															
xxxx 1110	15															
xxxx 1111	16															

MGC629

Fig.6 Character set 'L' in CGROM; PCF2104L.

LCD controller/driver

PCF2104x

upper 4 bits lower 4 bits	0000	0001	0010	0011	0100	0101	0110	0111	1000	1001	1010	1011	1100	1101	1110	1111
xxxx 0000	CG RAM 1															
xxxx 0001	2															
xxxx 0010	3															
xxxx 0011	4															
xxxx 0100	5															
xxxx 0101	6															
xxxx 0110	7															
xxxx 0111	8															
xxxx 1000	9															
xxxx 1001	10															
xxxx 1010	11															
xxxx 1011	12															
xxxx 1100	13															
xxxx 1101	14															
xxxx 1110	15															
xxxx 1111	16															

MGM134

Fig.7 Character set 'N' in CGROM; PCF2104N.

LCD controller/driver

PCF2104x

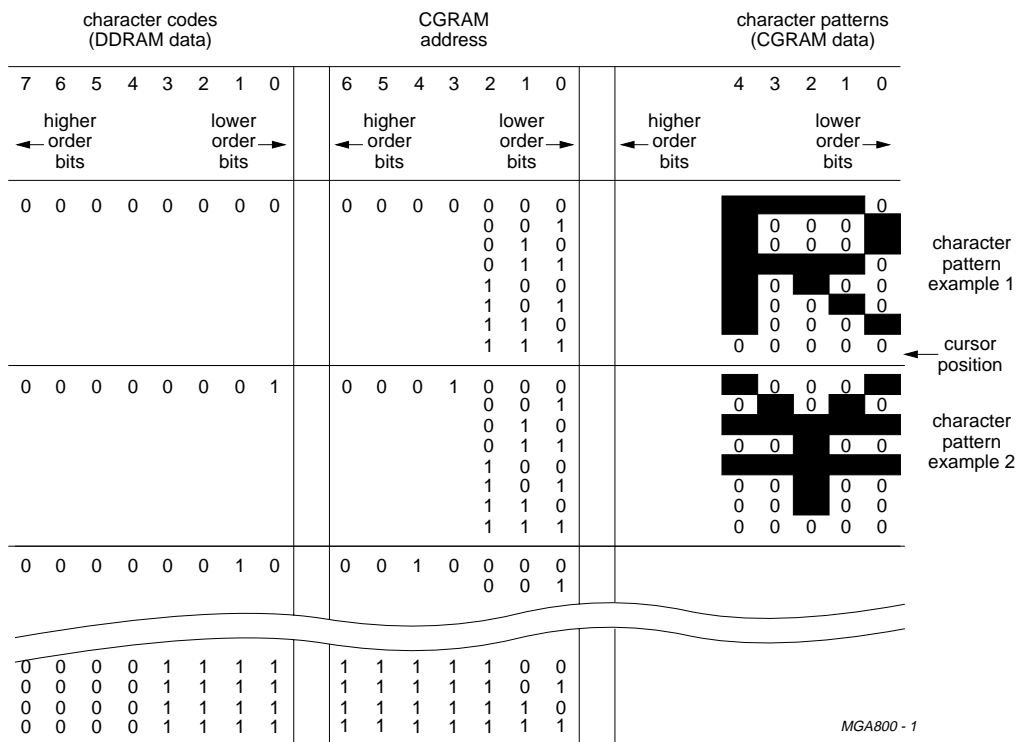

Character code bits 0 to 3 correspond to CGRAM address bits 3 to 6.

CGRAM address bits 0 to 2 designate character pattern line position. The 8<sup>th</sup> line is the cursor position and display is performed by logical OR with the cursor. Data in the 8<sup>th</sup> line will appear in the cursor position.

Character pattern column positions correspond to CGRAM data bits 0 to 4; bit 4 being at the left end, as shown in the figure.

CGRAM character patterns are selected when character code bits 4 to 7 are all logic 0. CGRAM data = logic 1 corresponds to selection for display.

Only bits 0 to 5 of the CGRAM address are set by the 'Set CGRAM address' instruction. Bit 6 can be set using the 'Set DDRAM address' instruction or by using the auto-increment feature during CGRAM write. All bits 0 to 6 can be read using the 'Read Busy Flag and address' instruction.

Fig.8 Relationship between CGRAM addresses, data and display patterns.

LCD controller/driver

PCF2104x

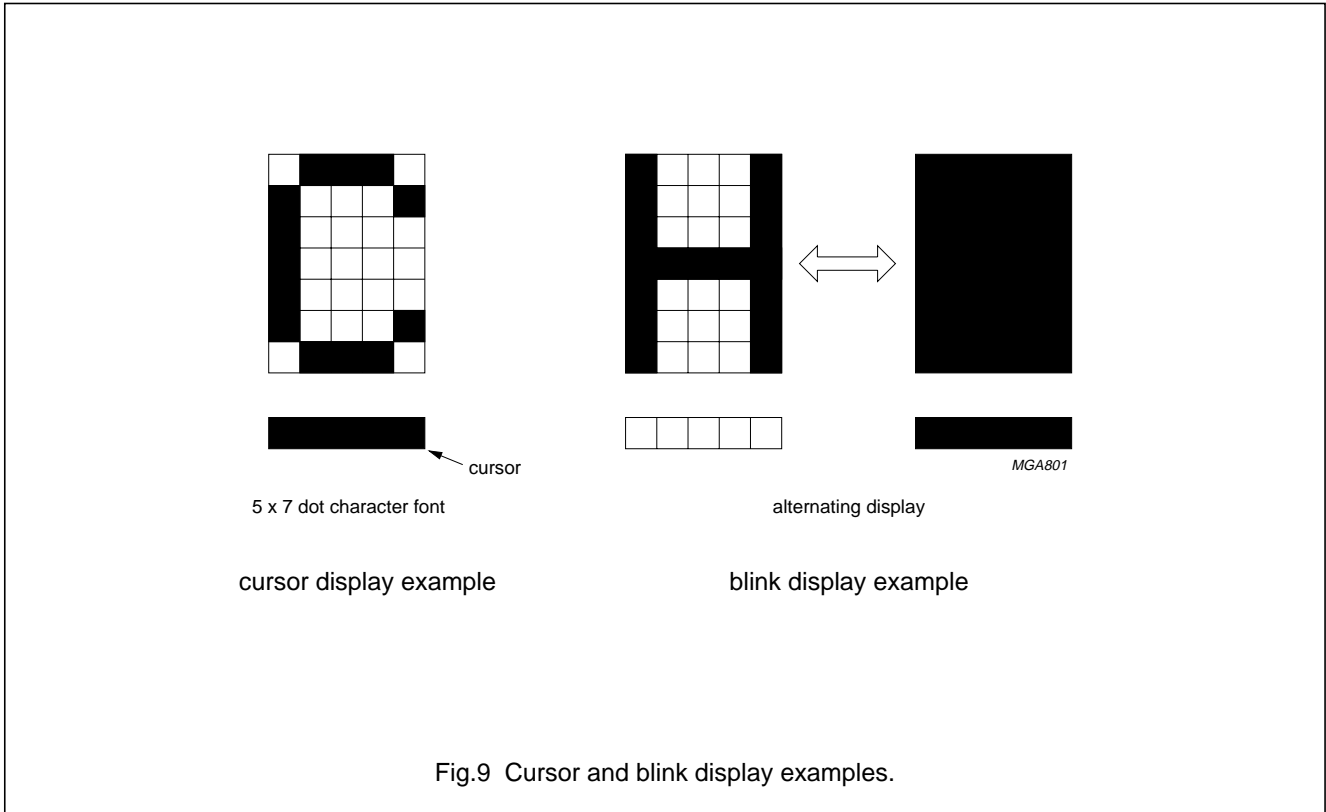

Fig.9 Cursor and blink display examples.

LCD controller/driver

PCF2104x

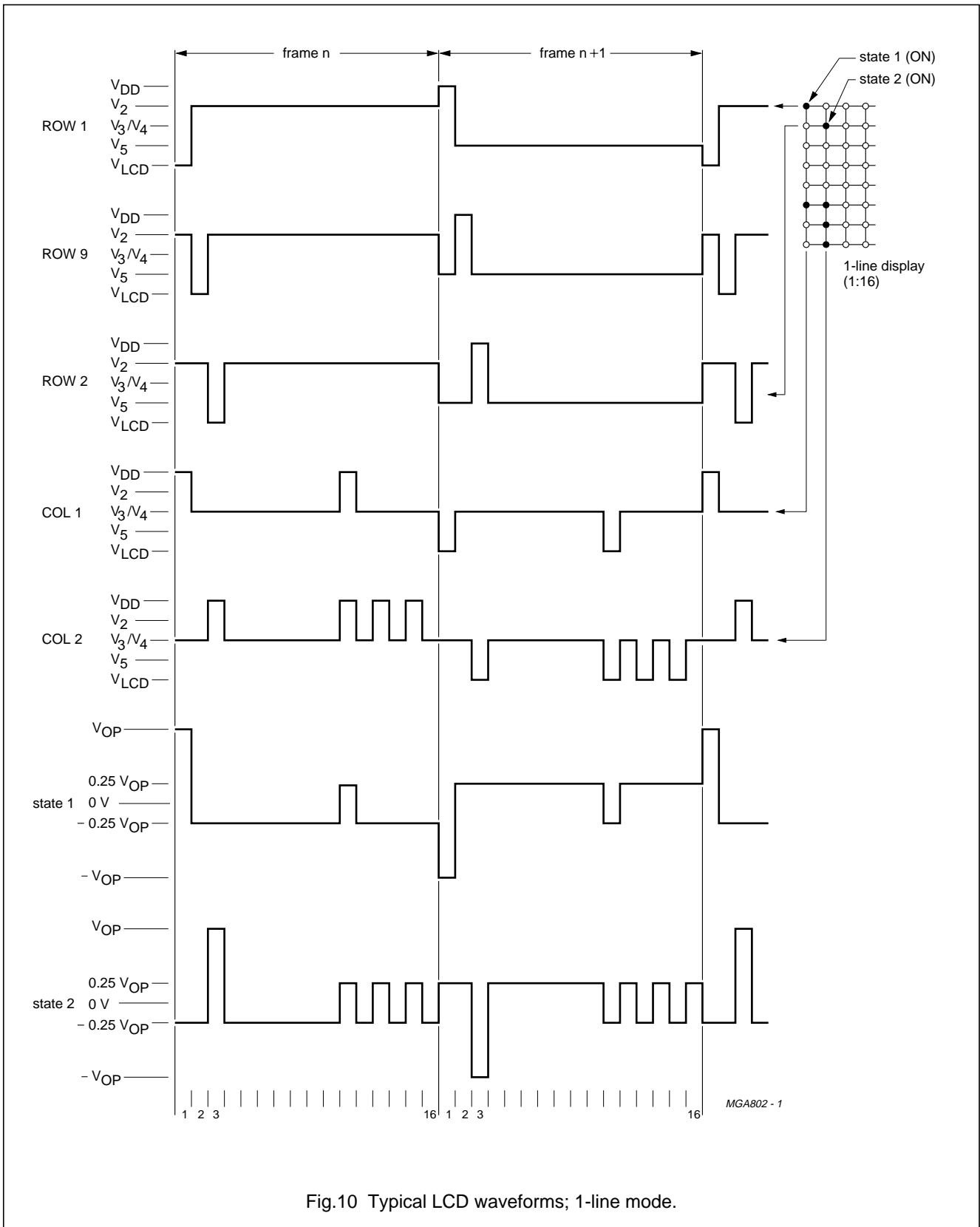

Fig.10 Typical LCD waveforms; 1-line mode.

LCD controller/driver

PCF2104x

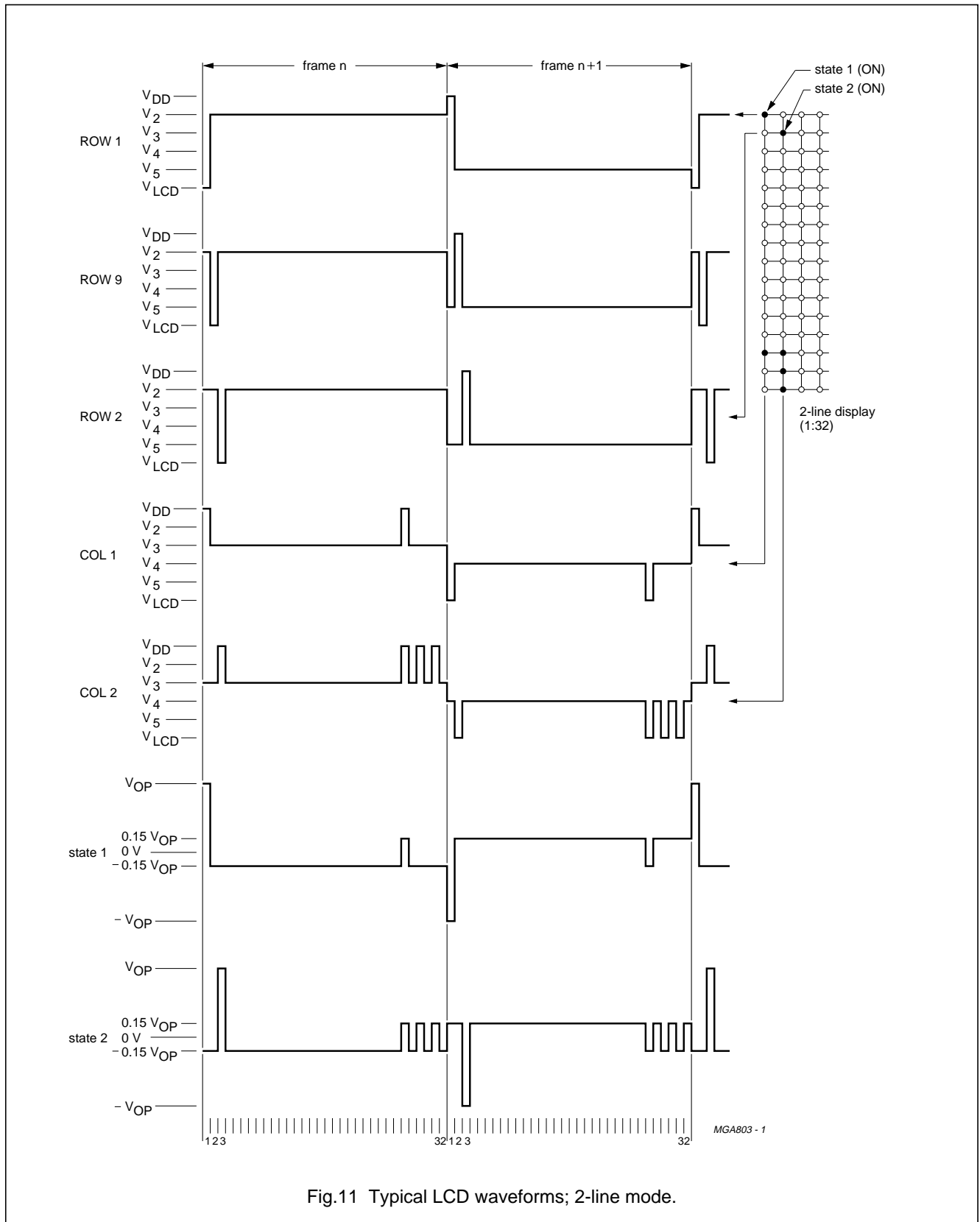

Fig.11 Typical LCD waveforms; 2-line mode.



LCD controller/driver

PCF2104x

**8.14 Programming of MUX 1 : 16 displays with PCF2104x**

The PCF2104x can be used in the following ways:

- 1-line mode to drive a 2-line display
- 2 × 12 characters with MUX rate 1 : 16, resulting in better contrast. The internal data flow of the chip is optimized for this purpose.

Using the 'Function set' instruction, M and N are set to 0, 0 (respectively). Figures 12, 13 and 14 show the DDRAM addresses of the display characters. The second row of each table corresponds to either the right half of a 1-line display or to the second line of a 2-line display. Wrap around of data during display shift or when writing data is non-standard.

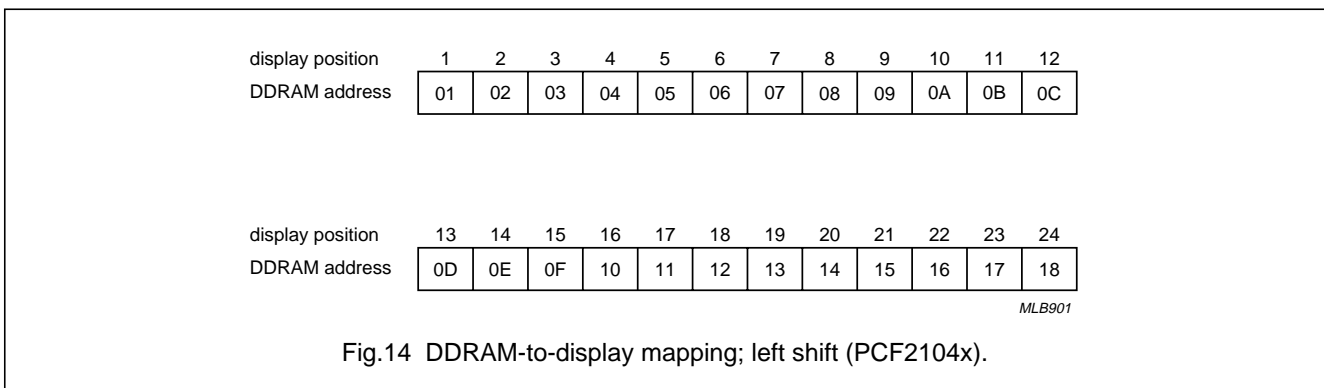
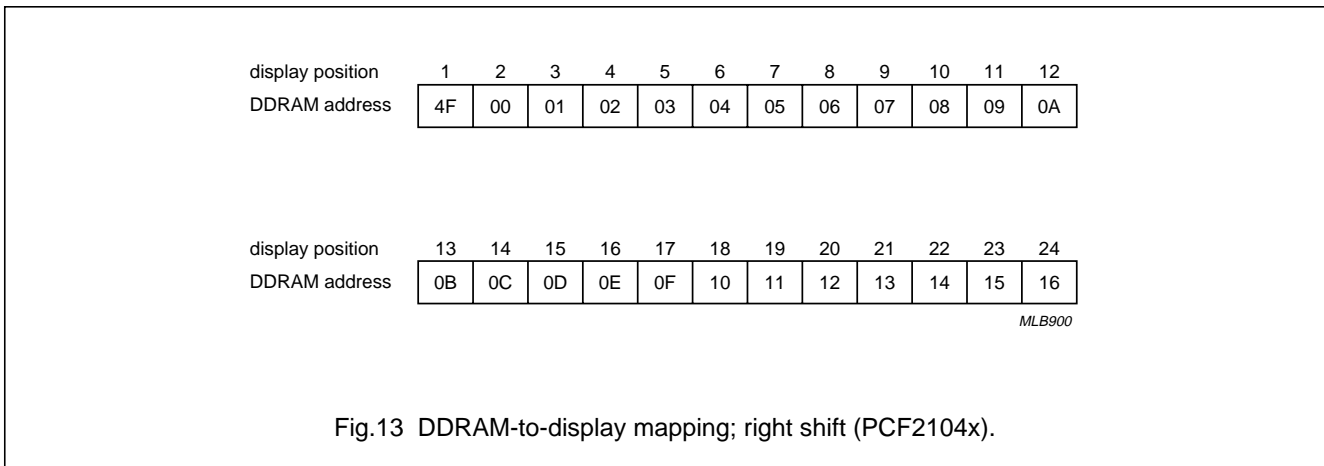
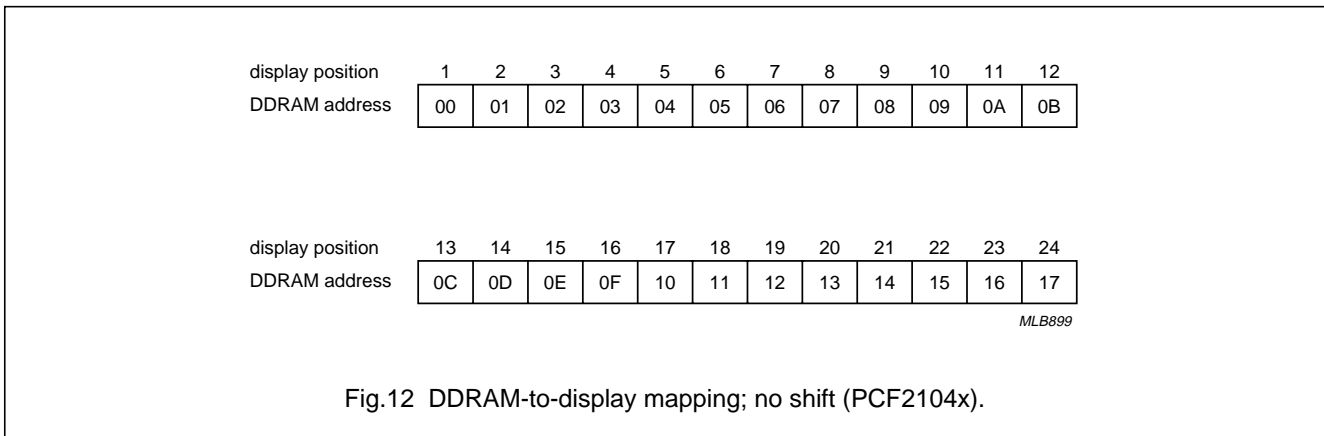

## LCD controller/driver

## PCF2104x

**8.15 Programming of MUX 1 : 32 displays with PCF2104x**

To drive a 2-line by 24 characters MUX 1 : 32 display, use instruction 'Function set' to set M, N to 0, 1 (respectively).

To drive a 4-line by 12 characters MUX 1:32 display, use instruction 'Function set' to set M, N to 1, 1 (respectively).

**8.16 Reset function**

The PCF2104 automatically initializes (resets) when power is turned on. The state after reset is given in Table 2.

**Table 2** State after reset

STEP	DESCRIPTION
1	Display clear.
2	Function set: DL = 1: 8-bit interface M, N = 0 1-line display G = 0: not used
3	Display on/off control: D = 0: display off C = 0: cursor off; B = 0: blink off;
4	Entry mode set: I/D = 1: +1 (increment) G = 0: not used
5	Default address pointer to DDRAM. The Busy Flag (BF) indicates the busy state (BF = logic 1) until initialization ends. The busy state lasts 2 ms. The chip may also be initialized by software. See Tables 10 and 11.
6	I <sup>2</sup> C-bus interface reset.

**9 INSTRUCTIONS**

Only two PCF2104x registers, the instruction register (IR) and the data register (DR) can be directly controlled by the microcontroller. Before internal operation, control information is stored temporarily in these registers to allow interface to various types of microcontrollers which operate at different speeds or to allow interfacing to peripheral control ICs.

The PCF2104x operation is controlled by the instructions shown in Table 3 together with their execution time. Details are explained in subsequent sections.

Instructions are of 4 categories, those that:

1. Designate PCF2104x functions such as display format, data length, etc.
2. Set internal RAM addresses
3. Perform data transfer with internal RAM
4. Others.

In normal use, category 3 instructions are used most frequently. However, automatic incrementing by 1 (or decrementing by 1) of internal RAM addresses after each data write lessens the microcontroller program load. The display shift in particular can be performed concurrently with display data write, thus enabling the designer to develop systems in minimum time with maximum programming efficiency.

During internal operation, no instruction other than the Busy Flag/address read instruction will be executed.

Because the Busy Flag is set to logic 1 while an instruction is being executed, it is advisable to ensure that the flag is at logic 0 before sending the next instruction or wait for the maximum instruction execution time, as given in Table 3. An instruction sent while the Busy Flag is HIGH will not be executed.

## LCD controller/driver

PCF2104X

**Table 3** Instructions (note 1)

INSTRUCTION	RS	R/W	DB7	DB6	DB5	DB4	DB3	DB2	DB1	DB0	DESCRIPTION	REQUIRED CLOCK CYCLES <sup>(2)</sup>
NOP	0	0	0	0	0	0	0	0	0	0	No operation.	0
Clear display	0	0	0	0	0	0	0	0	0	1	Clears entire display and sets DDRAM address 0 in Address Counter.	165
Return home	0	0	0	0	0	0	0	0	1	0	Sets DDRAM address 0 in Address Counter Also returns shifted display to original position DDRAM contents remain unchanged.	3
Entry mode set	0	0	0	0	0	0	0	1	I/D	S	Sets cursor move direction and specifies shift of display. These operations are performed during data write and read.	3
Display control	0	0	0	0	0	0	1	D	C	B	Sets entire display on/off (D), cursor on/off (C) and blink of cursor position character (B).	3
Cursor/display shift	0	0	0	0	0	1	S/C	R/L	0	0	Moves cursor and shifts display without changing DDRAM contents.	3
Function set	0	0	0	0	1	DL	N	M	G	0	Sets interface data length (DL), number of display lines (N, M) and voltage generator control (G).	3
Set CGRAM address	0	0	0	1	A <sub>CG</sub>						Sets CGRAM address.	3
Set DDRAM address	0	0	1	A <sub>DD</sub>						Sets DDRAM address.	3	
Read busy flag and address	0	1	BF	A <sub>C</sub>						Reads Busy Flag (BF) indicating internal operation is being performed and reads Address Counter contents.	0	
Read data	1	1	read data						Reads data from CGRAM or DDRAM.	3		
Write data	1	0	write data						Writes data to CGRAM or DDRAM.	3		

**Notes**

1. In the I<sup>2</sup>C-bus mode the DL bit is don't care. 8-bit mode is assumed.

In the I<sup>2</sup>C-bus mode a control byte is required when RS or R/W is changed; control byte: Co, RS, R/W, 0, 0, 0, 0, 0; command byte: DB7 to DB0.

2. Example:  $f_{\text{osc}} = 150 \text{ kHz}$ ,  $T_{\text{cy}} = \frac{1}{f_{\text{osc}}} = 6.67 \text{ } \mu\text{s}$ ; 3 cycles = 20  $\mu\text{s}$ , 165 cycles = 1.1 ms.

LCD controller/driver

PCF2104x

**Table 4** Command bit identities

BIT	LOGIC 0	LOGIC 1
I/D	decrement	increment
S	display freeze	display shift
D	display off	display on
C	cursor off	cursor on
B	character at cursor position does not blink	character at cursor position blinks
S/C	cursor move	display shift
R/L	left shift	right shift
DL	4 bits	8 bits
N (M = 0)	2 line × 12 characters; MUX 1 : 16	2 lines × 24 characters; MUX 1 : 32
N (M = 1)	reserved	4 lines × 12 characters; MUX 1 : 32
BF	end of internal operation	internal operation in progress
Co	last control byte, only data bytes to follow	next two bytes are a data byte and another control byte

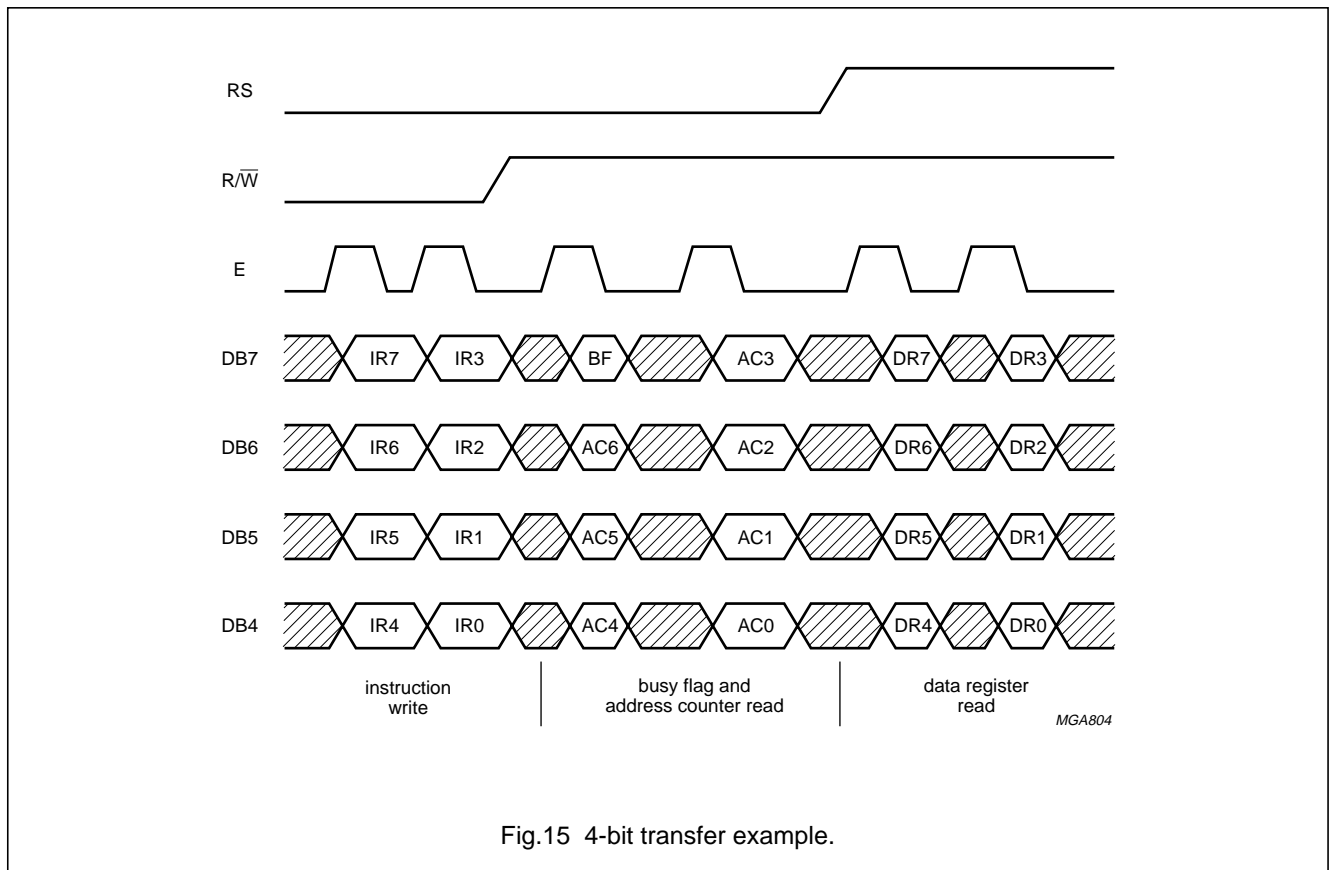
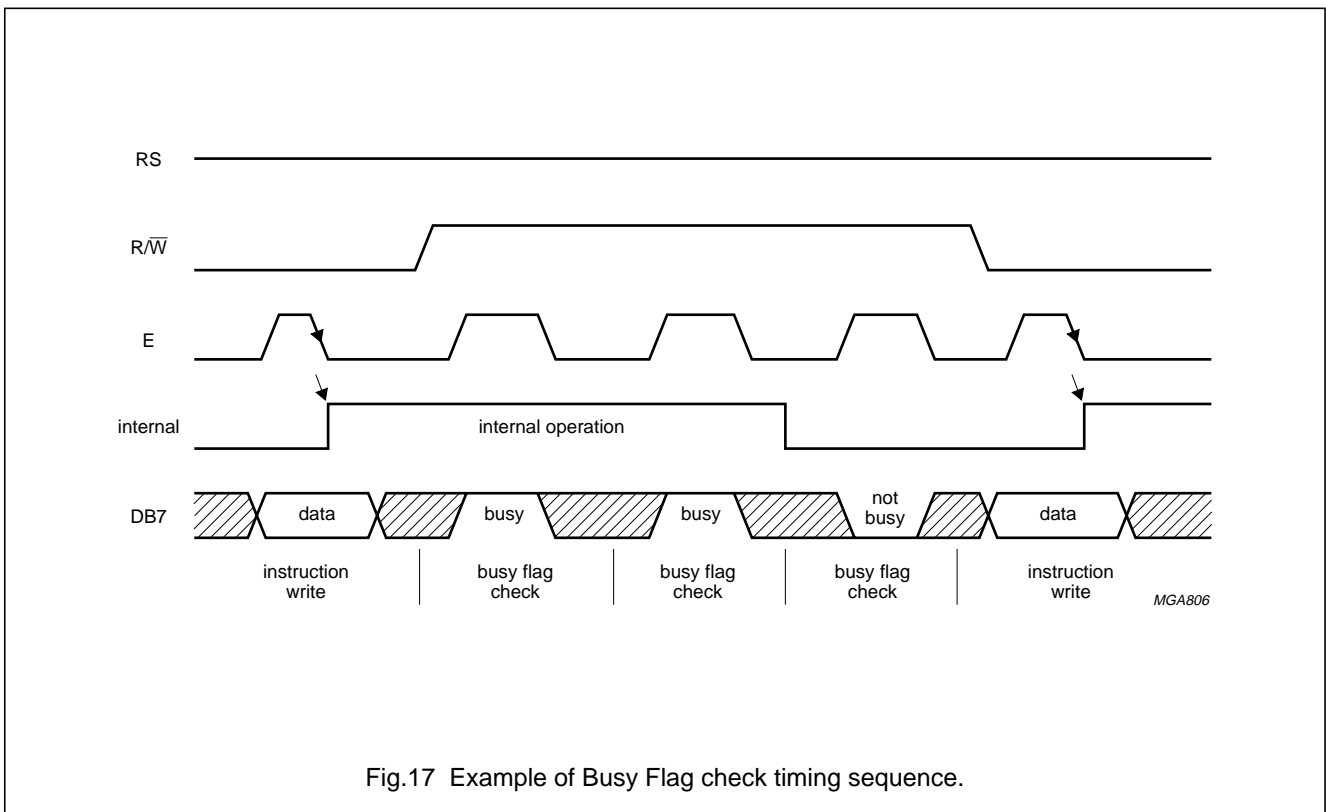
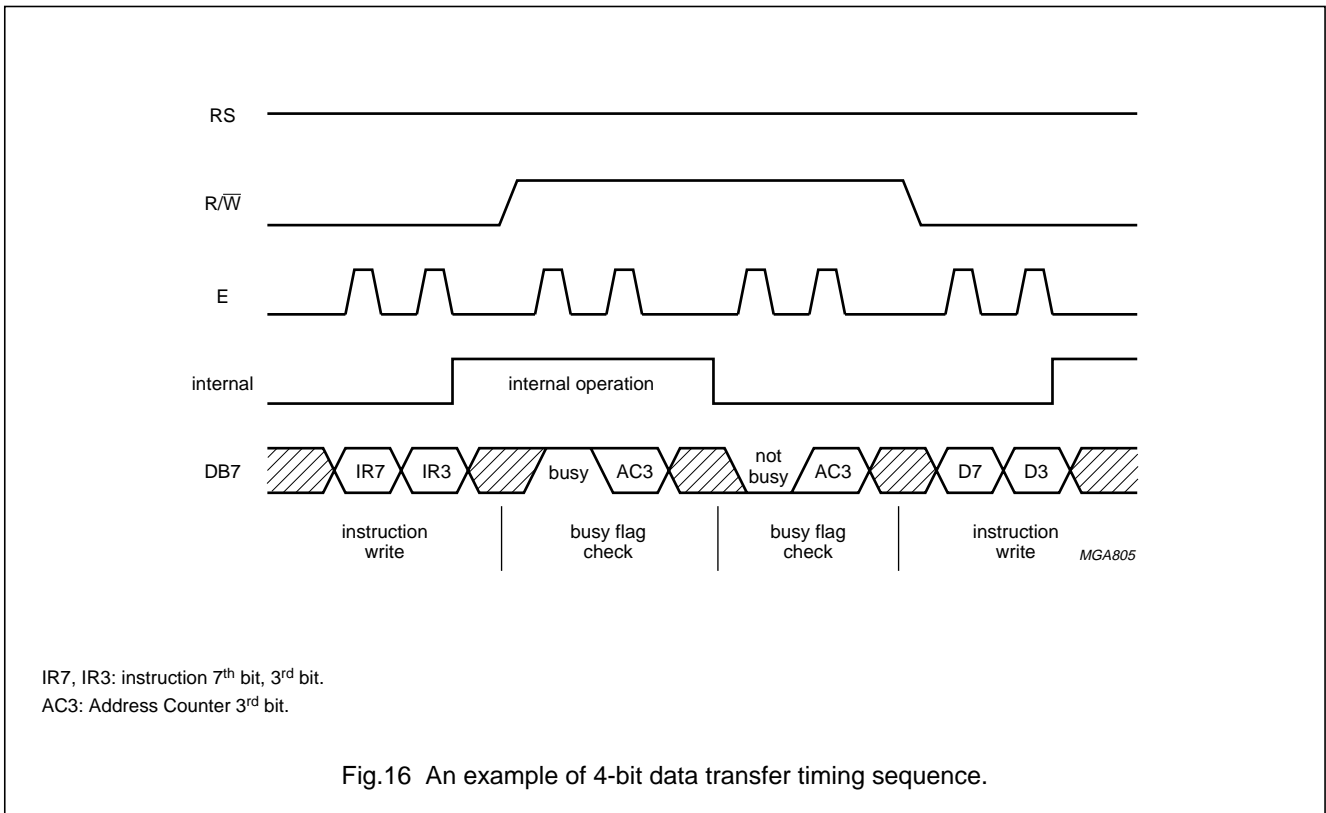

Fig.15 4-bit transfer example.

LCD controller/driver

PCF2104x



## LCD controller/driver

## PCF2104x

**9.1 Clear display**

'Clear display' writes space code 20 (hexadecimal) into all DDRAM addresses (the character pattern for character code 20 must be a blank pattern), sets the DDRAM Address Counter to logic 0 and returns the display to its original position if it was shifted. Consequently, the display disappears and the cursor or blink position goes to the left edge of the display (the first line if 2 or 4 lines are displayed) and sets the entry mode to I/D = logic 1 (increment mode). S of entry mode does not change.

The instruction 'Clear display' requires extra execution time. This may be allowed for by checking the Busy Flag (BF) or by waiting until 2 ms has elapsed. The latter must be applied where no read-back options are foreseen, as in some chip-on-glass (COG) applications.

**9.2 Return home**

'Return home' sets the DDRAM Address Counter to logic 0 and returns the display to its original position if it was shifted. DDRAM contents do not change. The cursor or blink position goes to the left of the display (the first line if 2 or 4 lines are displayed). I/D and S of entry mode do not change.

**9.3 Entry mode set****9.3.1 I/D**

When I/D = logic 1 (0) the DDRAM or CGRAM address increments (decrements) by 1 when data is written to or read from the DDRAM or CGRAM. The cursor or blink position moves to the right when incremented and to the left when decremented. The cursor and blink are inhibited when the CGRAM is accessed.

**9.3.2 S**

When S = logic 1, the entire display shifts either to the right (I/D = logic 0) or to the left (I/D = logic 1) during a DDRAM write. Consequently, it looks as if the cursor stands still and the display moves. The display does not shift when reading from the DDRAM, or when writing to or reading from the CGRAM. When S = logic 0 the display does not shift.

**9.4 Display on/off control****9.4.1 D**

The display is on when D = logic 1 and off when D = logic 0. Display data in the DDRAM is not affected and can be displayed immediately by setting D to logic 1.

**9.4.2 C**

The cursor is displayed when C = logic 1 and inhibited when C = logic 0. Even if the cursor disappears, the display functions I/D, etc. remain in operation during display data write. The cursor is displayed using 5 dots in the 8th line (see Fig.9).

**9.4.3 B**

The character indicated by the cursor blinks when B = logic 1. The blink is displayed by switching between display characters and all dots on with a period of 1 second when  $f_{osc} = 150 \text{ kHz}$  (see Fig.9). At other clock frequencies the blink period is equal to  $150 \text{ kHz}/f_{osc}$ . The cursor and the blink can be set to display simultaneously.

**9.5 Cursor/display shift**

'Cursor/display shift' moves the cursor position or the display to the right or left without writing or reading display data. This function is used to correct a character or move the cursor through the display. In 2 or 4-line displays, the cursor moves to the next line when it passes the last position of the line (40 or 20 decimal). When the displayed data is shifted repeatedly all lines shift at the same time; displayed characters do not shift into the next line. The Address Counter (AC) content does not change if the only action performed is shift display, but increments or decrements with the cursor shift.

**9.6 Function set****9.6.1 DL (PARALLEL MODE ONLY)**

Sets interface data width. Data is sent or received in bytes (DB7 to DB0) when DL = logic 1 or in two nibbles (DB7 to DB4) when DL = logic 0. When 4-bit width is selected, data is transmitted in two cycles using the parallel bus<sup>(1)</sup>.

Function set from I<sup>2</sup>C-bus interface: DL bit can not be set to logic 0 from the I<sup>2</sup>C-bus interface. If bit DL has been set to logic 0 via the parallel bus, programming via the I<sup>2</sup>C-bus interface is complicated.

**9.6.2 N, M**

Sets number of display lines.

(1) In a 4-bit application DB3 to DB0 are left open (internal pull-ups). Hence in the first function set instruction after power-on G and H are set to 1. A second function set must then be sent (2 nibbles) to set G and H to their required values.

## LCD controller/driver

## PCF2104x

**9.7 Set CGRAM address**

'Set CGRAM address' sets bits 0 to 5 of the CGRAM address ( $A_{CG}$  in Table 3) into the Address Counter (binary  $A[5]$  to  $A[0]$ ). Data can then be written to or read from the CGRAM.

Only bits 0 to 5 of the CGRAM address are set by the 'Set CGRAM address' instruction. Bit 6 can be set using the 'Set DDRAM address' instruction or by using the auto-increment feature during CGRAM write. All bits 0 to 6 can be read using the 'Read busy flag and address' instruction.

**9.8 Set DDRAM address**

Set DDRAM address sets the DDRAM address ( $A_{DD}$  in Table 3) into the Address Counter (binary  $A[6]$  to  $A[0]$ ). Data can then be written to or read from the DDRAM.

**Table 5** Hexadecimal address ranges

ADDRESS	FUNCTION
00 to 4F	1-line by 24
00 to 0B and 0C to 4F	2-line by 12
00 to 27 and 40 to 67	2-line by 24
00 to 13, 20 to 33, 40 to 53 and 60 to 73	4-line by 12

**9.9 Read busy flag and address**

'Read busy flag and address' reads the Busy Flag (BF). When  $BF = \text{logic } 1$  it indicates that an internal operation is in progress. The next instruction will not be executed until  $BF = \text{logic } 0$ , so BF should be checked before sending another instruction.

At the same time, the value of the Address Counter expressed in binary  $A[6]$  to  $A[0]$  is read out. The Address Counter is used by both CGRAM and DDRAM and its value is determined by the previous instruction.

**9.10 Write data to CGRAM or DDRAM**

Writes binary 8-bit data  $D[7]$  to  $D[0]$  to the CGRAM or the DDRAM.

Whether the CGRAM or DDRAM is to be written to is determined by the previous specification of CGRAM or DDRAM address setting. After writing, the address automatically increments or decrements by 1, in accordance with the entry mode. Only bits  $D_0$  to  $D_4$  of CGRAM data are valid, bits  $D_5$  to  $D_7$  are 'don't care'.

**9.11 Read data from CGRAM or DDRAM**

Reads binary 8-bit data  $D[7]$  to  $D[0]$  from the CGRAM or DDRAM.

The most recent 'Set address' instruction determines whether the CGRAM or DDRAM is to be read.

The 'Read data' instruction gates the content of the data register (DR) to the bus while  $E = \text{HIGH}$ . After E goes LOW again, internal operation increments (or decrements) the AC and stores RAM data corresponding to the new AC into the DR.

Remark: the only three instructions that update the data register (DR) are:

- 'Set CGRAM address'
- 'Set DDRAM address'
- 'Read data' from CGRAM or DDRAM.

Other instructions (e.g. 'Write data', 'Cursor/display shift', 'Clear display', 'Return home') will not modify the data register content.

**10 INTERFACE TO MICROCONTROLLER (PARALLEL INTERFACE)**

The PCF2104x can send data in either two 4-bit operations or one 8-bit operation and can thus interface to 4-bit or 8-bit microcontrollers.

In the 8-bit mode data is transferred as 8-bit bytes using the 8 data lines  $DB_0$  to  $DB_7$ . Three further control lines E, RS, and  $R/\overline{W}$  are required.

In the 4-bit mode data is transferred in two cycles of 4-bits each. The higher order bits (corresponding to  $DB_4$  to  $DB_7$  in 8-bit mode) are sent in the first cycle and the lower order bits ( $DB_0$  to  $DB_3$  in 8-bit mode) in the second cycle.

Data transfer is complete after two 4-bit data transfers. It should be noted that two cycles are also required for the Busy Flag check. 4-bit operation is selected by instruction. See Figs 15, 16 and 17 for examples of bus protocol.

In the 4-bit mode pins  $DB_3$  to  $DB_0$  must be left open-circuit. They are pulled up to  $V_{DD}$  internally.

## LCD controller/driver

## PCF2104x

## 11 INTERFACE TO MICROCONTROLLER (I<sup>2</sup>C-BUS INTERFACE)

### 11.1 Characteristics of the I<sup>2</sup>C-bus

The I<sup>2</sup>C-bus is for bidirectional, two-line communication between different ICs or modules. The two lines are a serial data line (SDA) and a serial clock line (SCL). Both lines must be connected to a positive supply via a pull-up resistor. Data transfer may be initiated only when the bus is not busy.

### 11.2 Bit transfer

One data bit is transferred during each clock pulse. The data on the SDA line must remain stable during the HIGH period of the clock pulse as changes in the data line at this time will be interpreted as a control signal.

### 11.3 Start and stop conditions

Both data and clock lines remain HIGH when the bus is not busy. A HIGH-to-LOW transition of the data line, while the clock is HIGH is defined as the START condition (S). A LOW-to-HIGH transition of the data line while the clock is HIGH is defined as the STOP condition (P).

### 11.4 System configuration

A device generating a message is a 'transmitter', a device receiving a message is the 'receiver'. The device that controls the message is the 'master' and the devices which are controlled by the master are the 'slaves'.

### 11.5 Acknowledge

The number of data bytes transferred between the start and stop conditions from transmitter to receiver is unlimited. Each byte of eight bits is followed by an acknowledge bit. The acknowledge bit is a HIGH level signal put on the bus by the transmitter during which time the master generates an extra acknowledge related clock pulse. A slave receiver which is addressed must generate an acknowledge after the reception of each byte. Also a master receiver must generate an acknowledge after the reception of each byte that has been clocked out of the slave transmitter. The device that acknowledges must pull-down the SDA line during the acknowledge clock pulse, so that the SDA line is stable LOW during the HIGH period of the acknowledge related clock pulse (set-up and hold times must be taken into consideration). A master receiver must signal an end of data to the transmitter by not generating an acknowledge on the last byte that has been clocked out of the slave. In this event the transmitter must leave the data line HIGH to enable the master to generate a stop condition.

### 11.6 I<sup>2</sup>C-bus protocol

Before any data is transmitted on the I<sup>2</sup>C-bus, the device which should respond is addressed first. The addressing is always carried out with the first byte transmitted after the start procedure. The I<sup>2</sup>C-bus configuration for the different PCF2104x READ and WRITE cycles is illustrated in Figs 22, 23 and 24.

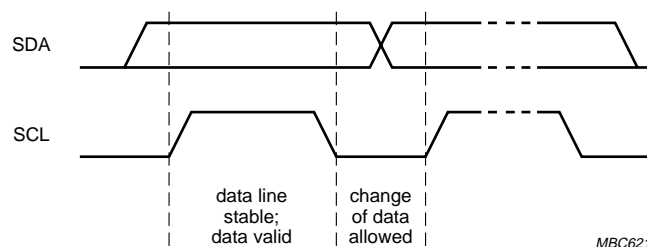

Fig.18 Bit transfer.



LCD controller/driver

PCF2104x

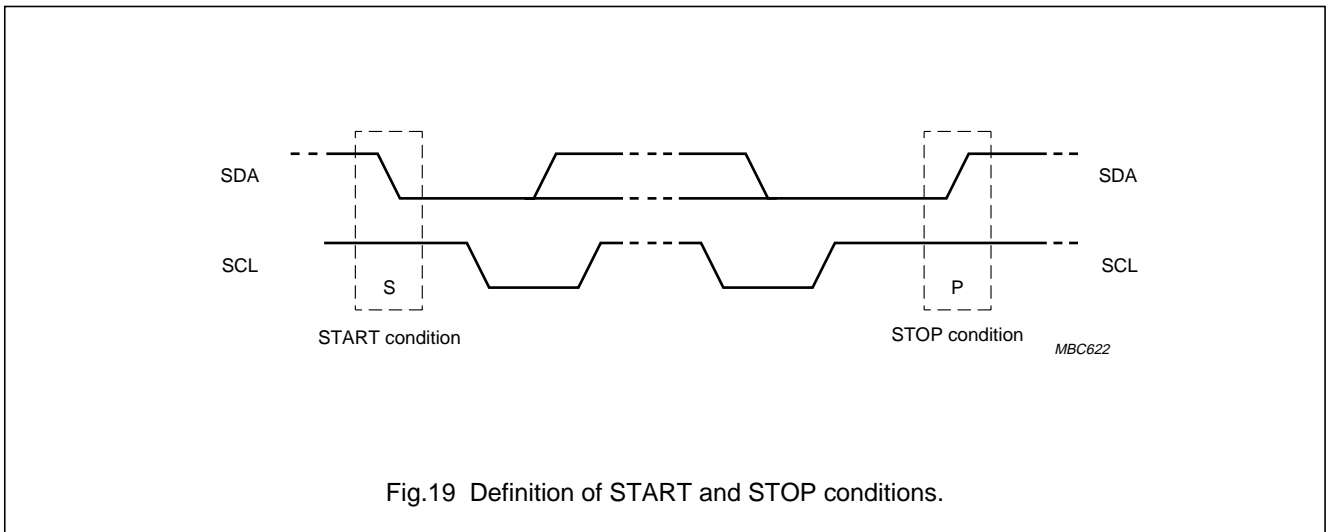

Fig.19 Definition of START and STOP conditions.

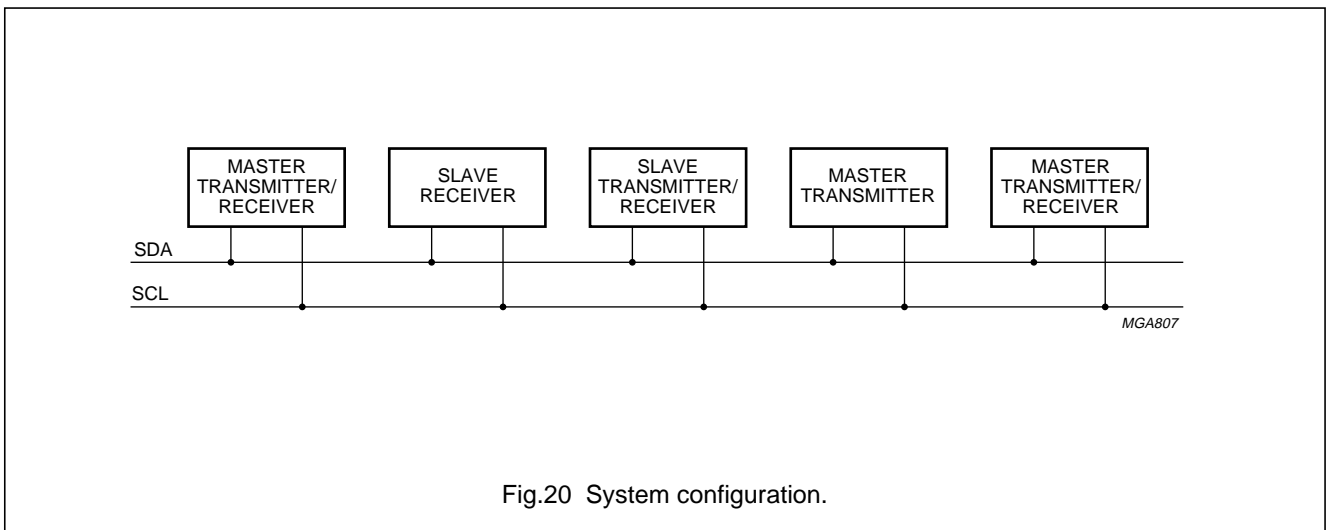

Fig.20 System configuration.

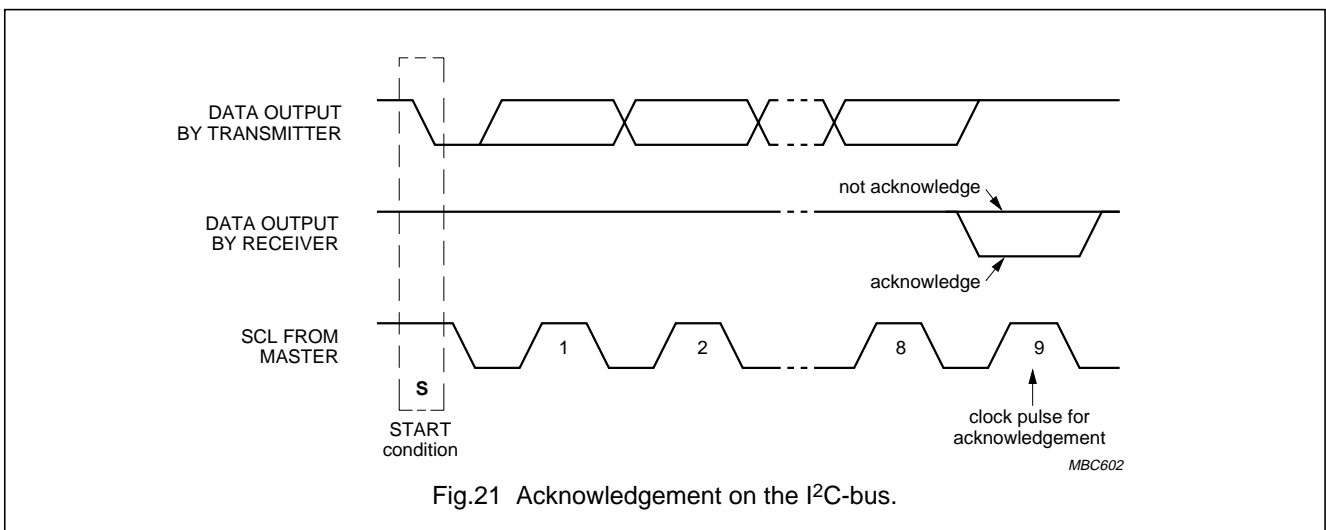

Fig.21 Acknowledgement on the I<sup>2</sup>C-bus.

LCD controller/driver

PCF2104X

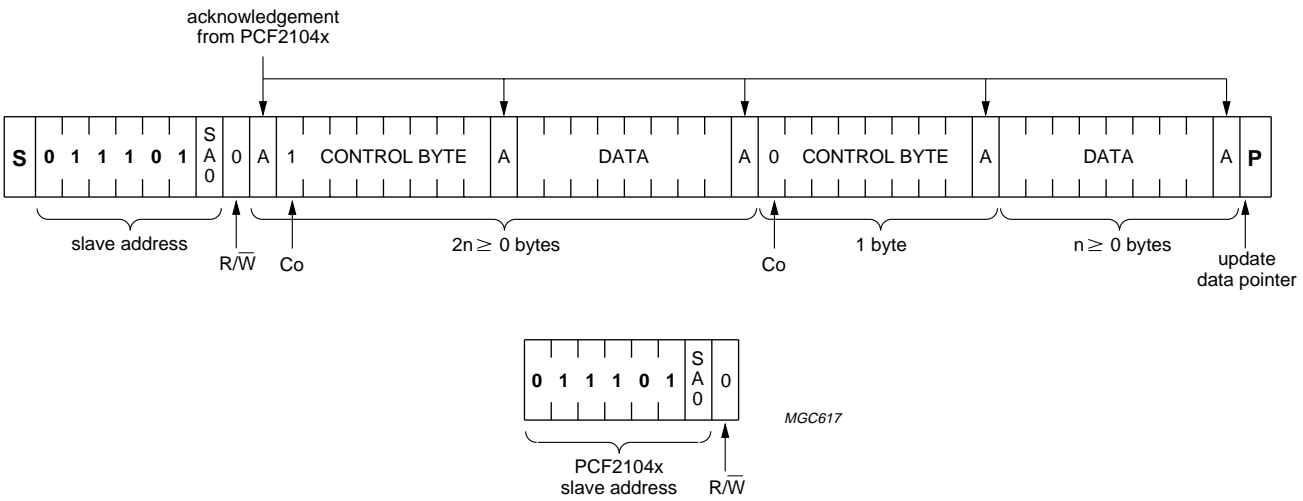
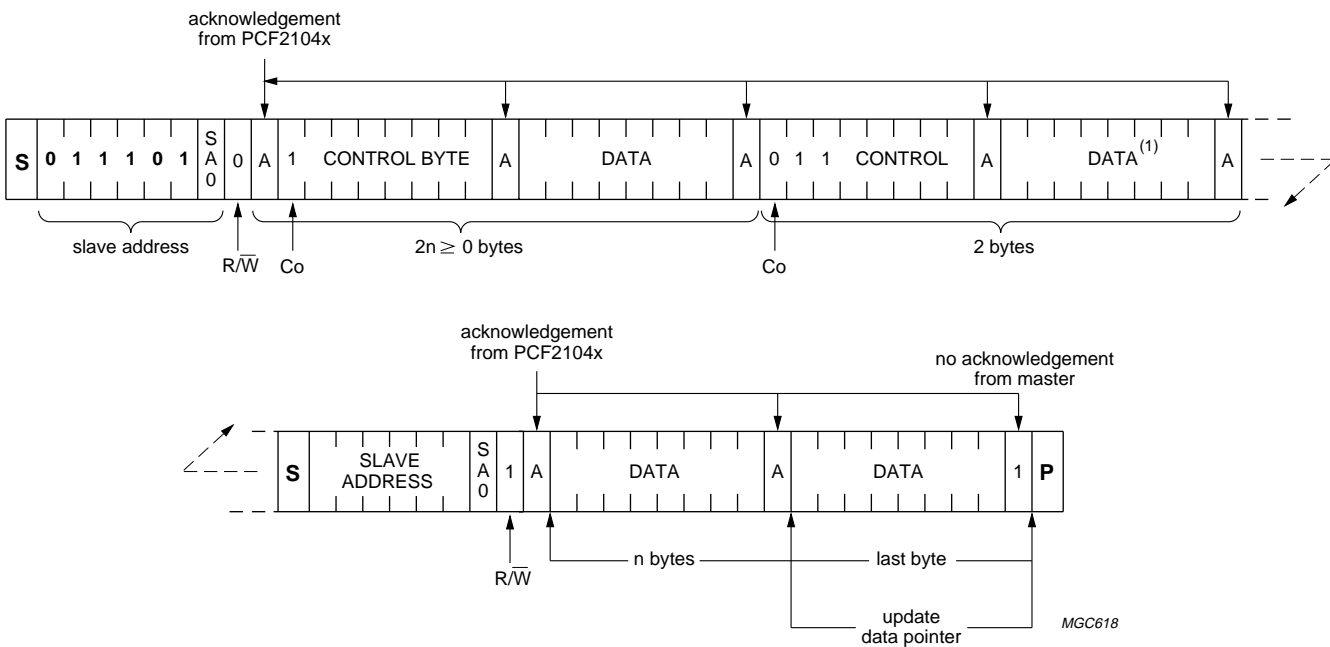

Fig.22 Master transmits to slave receiver; WRITE mode.

LCD controller/driver

PCF2104X



(1) Last data byte is a dummy byte (may be omitted).

Fig.23 Master reads after setting word address; write word address, set RS/RW; READ data.

LCD controller/driver

PCF2104x

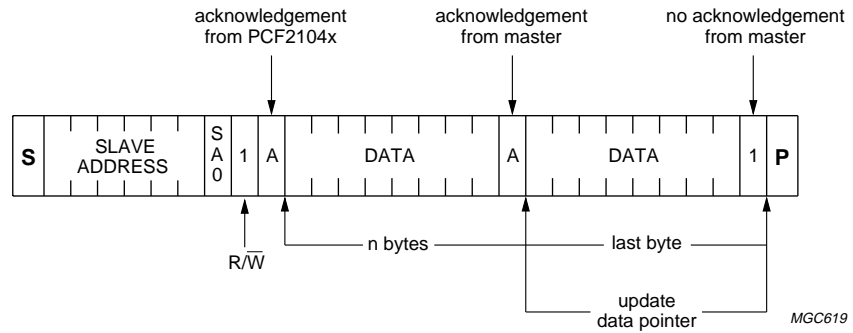

Fig.24 Master reads slave immediately after first byte; READ mode (RS previously defined).

LCD controller/driver

PCF2104X

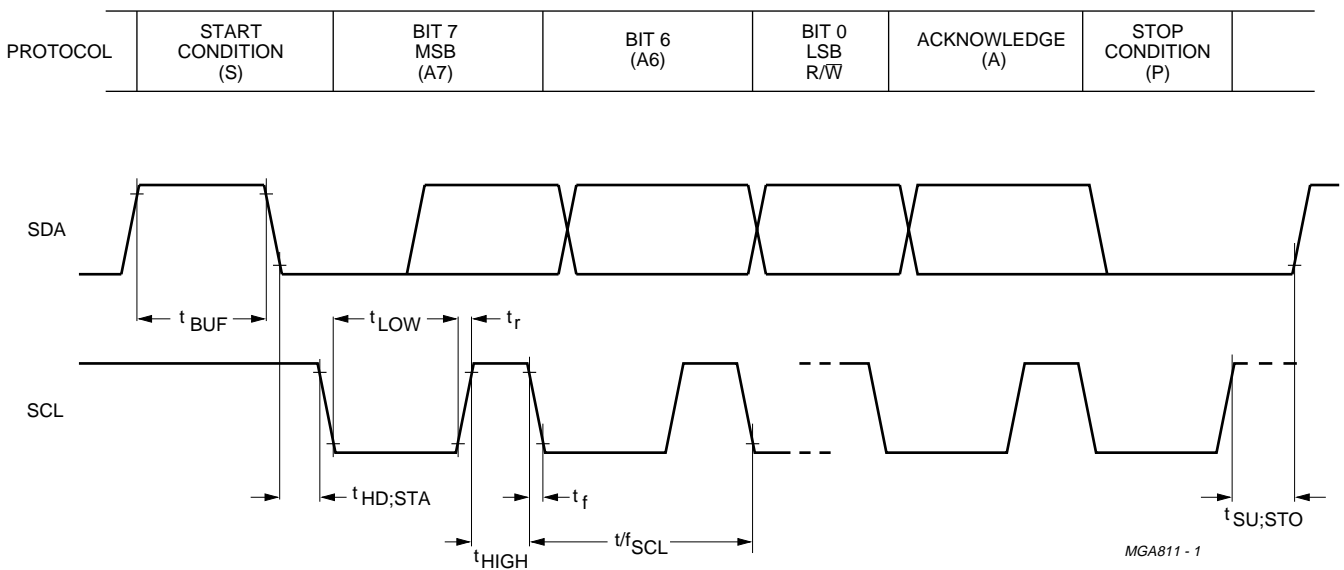

Fig.25 I<sup>2</sup>C-bus timing diagram; rise and fall times refer to  $V_{IL}$  and  $V_{IH}$ .

## LCD controller/driver

## PCF2104x

**12 LIMITING VALUES**

In accordance with the Absolute Maximum Rating System (IEC 134).

SYMBOL	PARAMETER	MIN.	MAX.	UNIT
$V_{DD}$	supply voltage	-0.5	+8.0	V
$V_{LCD}$	LCD supply voltage	$V_{DD} - 11$	$V_{DD}$	V
$V_I$	input voltage OSC, RS, $\overline{R/W}$ , E and DB0 to DB7	$V_{SS} - 0.5$	$V_{DD} + 0.5$	V
$V_O$	output voltage R1 to R32, C1 to C60 and $V_{LCD}$	$V_{LCD} - 0.5$	$V_{DD} + 0.5$	V
$I_I$	DC input current	-10	+10	mA
$I_O$	DC output current	-10	+10	mA
$I_{DD}, I_{SS}, I_{LCD}$	$V_{DD}, V_{SS}$ or $V_{LCD}$ current	-50	+50	mA
$P_{tot}$	total power dissipation	-	400	mW
$P_O$	power dissipation per output	-	100	mW
$T_{stg}$	storage temperature	-65	+150	°C

**13 HANDLING**

Inputs and outputs are protected against electrostatic discharge in normal handling. However, to be totally safe, it is desirable to take normal precautions appropriate to handling MOS devices (see "Handling MOS Devices").

**14 DC CHARACTERISTICS**

$V_{DD} = 2.5$  to  $6$  V;  $V_{SS} = 0$  V;  $V_{LCD} = V_{DD} - 3.5$  to  $V_{DD} - 9$  V;  $T_{amb} = -40$  to  $+85$  °C; unless otherwise specified.

SYMBOL	PARAMETER	CONDITIONS	MIN.	TYP.	MAX.	UNIT
<b>Supplies</b>						
$V_{DD}$	supply voltage		2.5	-	6.0	V
$V_{LCD}$	LCD supply voltage		$V_{DD} - 9$	-	$V_{DD} - 3.5$	V
$I_{DD}$	supply current external $V_{LCD}$	note 1	-	-	-	
$I_{DD1}$	supply current 1		-	200	500	μA
$I_{DD2}$	supply current 2	$V_{DD} = 5$ V; $V_{OP} = 9$ V; $f_{osc} = 150$ kHz; $T_{amb} = 25$ °C	-	200	300	μA
$I_{DD3}$	supply current 3	$V_{DD} = 3$ V; $V_{OP} = 5$ V; $f_{osc} = 150$ kHz; $T_{amb} = 25$ °C	-	150	200	μA
$I_{LCD}$	$V_{LCD}$ input current	notes 1 and 6	-	50	100	μA
$V_{POR}$	Power-on reset voltage level	note 2	-	1.3	1.8	V

## LCD controller/driver

## PCF2104x

SYMBOL	PARAMETER	CONDITIONS	MIN.	TYP.	MAX.	UNIT
<b>Logic</b>						
$V_{IL1}$	LOW level input voltage pins E, RS, R/W, DB0 to DB7 and SA0		$V_{SS}$	–	$0.3V_{DD}$	V
$V_{IH1}$	HIGH level input voltage pins E, RS, R/W, DB0 to DB7 and SA0		$0.7V_{DD}$	–	$V_{DD}$	V
$V_{IL(osc)}$	LOW level input voltage pin OSC		$V_{SS}$	–	$V_{DD} - 1.5$	V
$V_{IH(osc)}$	HIGH level input voltage pin OSC		$V_{DD} - 0.1$	–	$V_{DD}$	V
$I_{pu}$	pull-up current at pins DB0 to DB7, RS and R/W	$V_I = V_{SS}$	0.04	0.15	1.00	$\mu A$
$I_{OL(DB)}$	LOW level output current pins DB0 to DB7	$V_{OL} = 0.4 V$ ; $V_{DD} = 5 V$	1.6	–	–	mA
$I_{OH(DB)}$	HIGH level output current pins DB0 to DB7	$V_{OH} = 4 V$ ; $V_{DD} = 5 V$	–1.0	–	–	mA
$I_{L1}$	leakage current pins OSC, E, RS, R/W, DB0 to DB7 and SA0	$V_I = V_{DD}$ or $V_{SS}$	–1	–	+1	$\mu A$
<b>I<sup>2</sup>C-bus</b>						
SDA, SCL						
$V_{IL2}$	LOW level input voltage	note 3	$V_{SS}$	–	$0.3V_{DD}$	V
$V_{IH2}$	HIGH level input voltage	note 3	$0.7V_{DD}$	–	$V_{DD}$	V
$I_{L2}$	leakage current	$V_I = V_{DD}$ or $V_{SS}$	–1	–	+1	$\mu A$
$C_i$	input capacitance	note 4	–	–	7	pF
$I_{OL(SDA)}$	LOW level output current (SDA)	$V_{OL} = 0.4 V$ ; $V_{DD} = 5 V$	3	–	–	mA
<b>LCD outputs</b>						
$R_{ROW}$	row output resistance pins R1 to R32	note 5	–	1.5	3	k $\Omega$
$R_{COL}$	column output resistance pins C1 to C60	note 5	–	3	6	k $\Omega$
$V_{tol1}$	bias voltage tolerance pins R1 to R32 and C1 to C60	note 6	–	$\pm 20$	$\pm 130$	mV

**Notes**

- LCD outputs are open-circuit; inputs at  $V_{DD}$  or  $V_{SS}$ ;  $V_0 = V_{DD}$ ; bus inactive; internal or external clock with duty cycle 50% ( $I_{DD1}$  only).
- Resets all logic when  $V_{DD} < V_{POR}$ .
- When the voltages are above or below the supply voltages  $V_{DD}$  or  $V_{SS}$ , an input current may flow; this current must not exceed  $\pm 0.5$  mA.
- Tested on sample basis.
- Resistance of output terminals (R1 to R32 and C1 to C60) with load current  $I_{load} = 150 \mu A$ ;  $V_{OP} = V_{DD} - V_{LCD} = 9 V$ ; outputs measured one at a time.
- LCD outputs open-circuit.

## LCD controller/driver

## PCF2104x

**15 AC CHARACTERISTICS**

$V_{DD} = 2.5$  to  $6.0$  V;  $V_{SS} = 0$  V;  $V_{LCD} = V_{DD} - 3.5$  V to  $V_{DD} - 9$  V;  $T_{amb} = -40$  °C to  $+85$  °C; unless otherwise specified.

SYMBOL	PARAMETER	CONDITIONS	MIN.	TYP.	MAX.	UNIT
$f_{FR}$	LCD frame frequency (internal clock)	note 1	40	65	100	Hz
$f_{osc}$	external clock frequency		90	150	225	kHz
<b>Bus timing characteristics: Parallel Interface; notes 1 and 2</b>						
WRITE OPERATION (WRITING DATA FROM MICROCONTROLLER TO PCF2104x)						
$T_{cy}$	enable cycle time		500	–	–	ns
$PW_{EH}$	enable pulse width		220	–	–	ns
$t_{ASU}$	address set-up time		50	–	–	ns
$t_{AH}$	address hold time		25	–	–	ns
$t_{DSW}$	data set-up time		60	–	–	ns
$t_{HD}$	data hold time		25	–	–	ns
READ OPERATION (READING DATA FROM PCF2104x TO MICROCONTROLLER)						
$T_{cy}$	enable cycle time		500	–	–	ns
$PW_{EH}$	enable pulse width		220	–	–	ns
$t_{ASU}$	address set-up time		50	–	–	ns
$t_{AH}$	address hold time		25	–	–	ns
$t_{DHD}$	data delay time		–	–	150	ns
$t_{HD}$	data hold time		20	–	100	ns
<b>Timing characteristics: I<sup>2</sup>C-bus interface; note 2</b>						
$f_{SCL}$	SCL clock frequency		–	–	100	kHz
$t_{SW}$	tolerable spike width on bus		–	–	100	ns
$t_{BUF}$	bus free time		4.7	–	–	µs
$t_{SU;STA}$	set-up time for a repeated START condition		4.7	–	–	µs
$t_{HD;STA}$	start condition hold time		4	–	–	µs
$t_{LOW}$	SCL LOW time		4.7	–	–	µs
$t_{HIGH}$	SCL HIGH time		4	–	–	µs
$t_r$	SCL and SDA rise time		–	–	1	µs
$t_f$	SCL and SDA fall time		–	–	0.3	µs
$t_{SU;DAT}$	data set-up time		250	–	–	ns
$t_{HD;DAT}$	data hold time		0	–	–	ns
$t_{SU;STO}$	set-up time for STOP condition		4	–	–	µs

**Notes**

- $V_{DD} = 5.0$  V.
- All timing values are valid within the operating supply voltage and ambient temperature range and are referenced to  $V_{IL}$  and  $V_{IH}$  with an input voltage swing of  $V_{SS}$  to  $V_{DD}$ .



LCD controller/driver

PCF2104x

16 TIMING DIAGRAMS

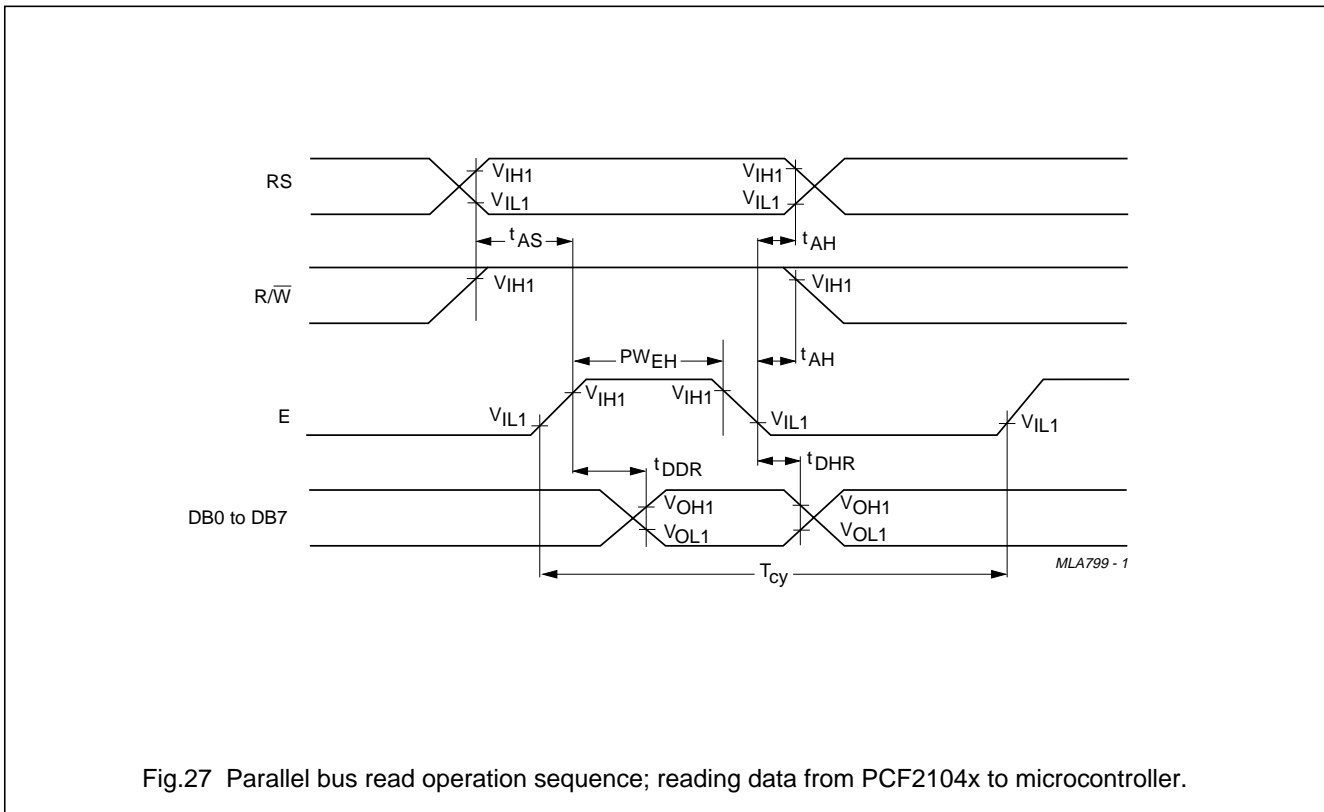
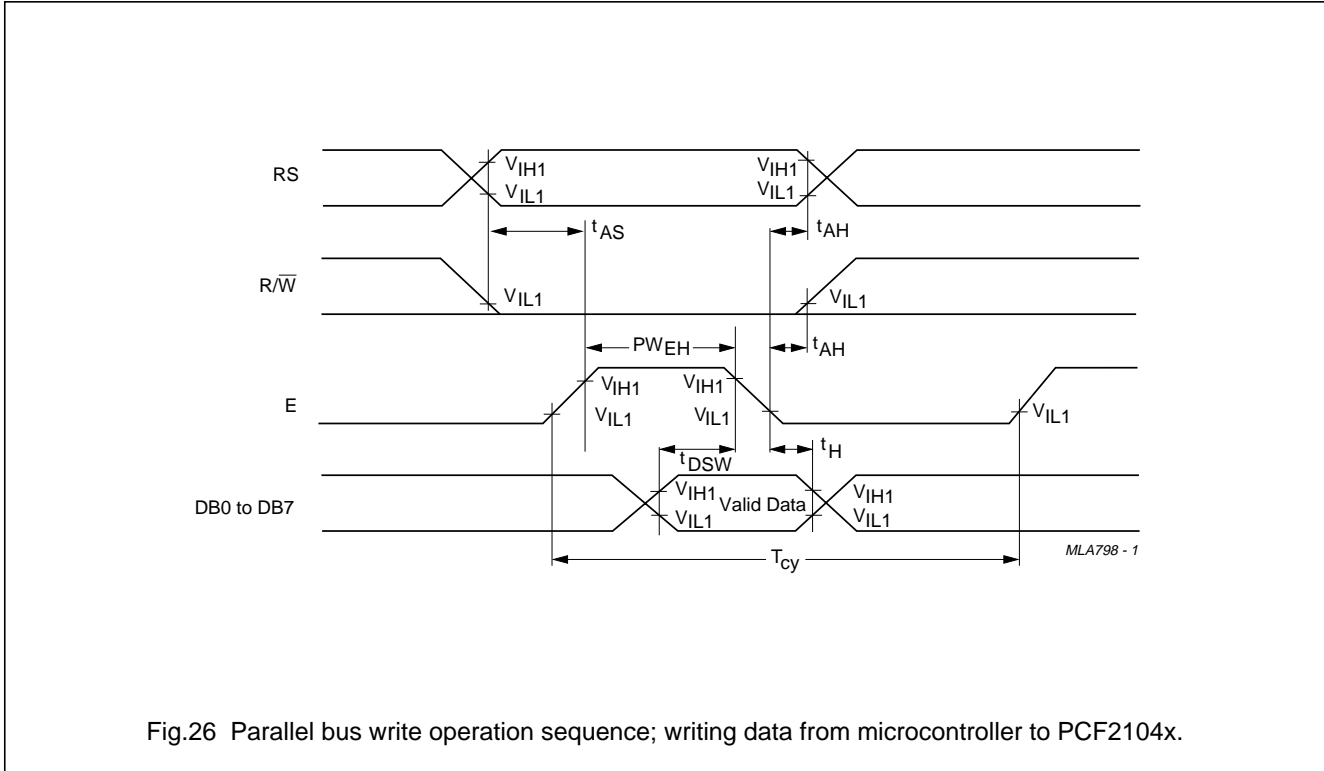

LCD controller/driver

PCF2104x

17 APPLICATION INFORMATION

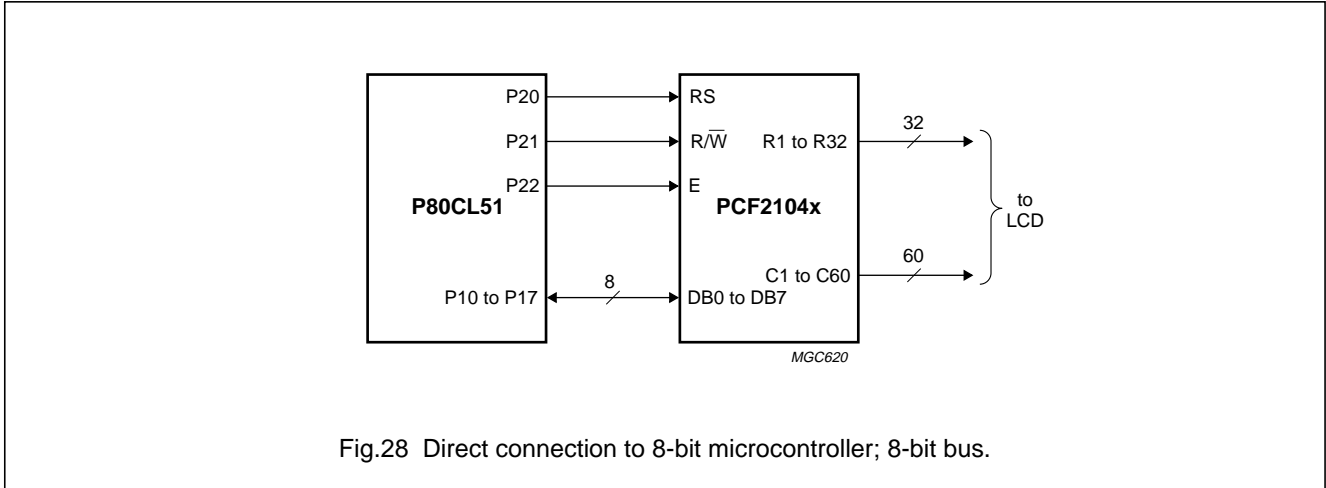

Fig.28 Direct connection to 8-bit microcontroller; 8-bit bus.

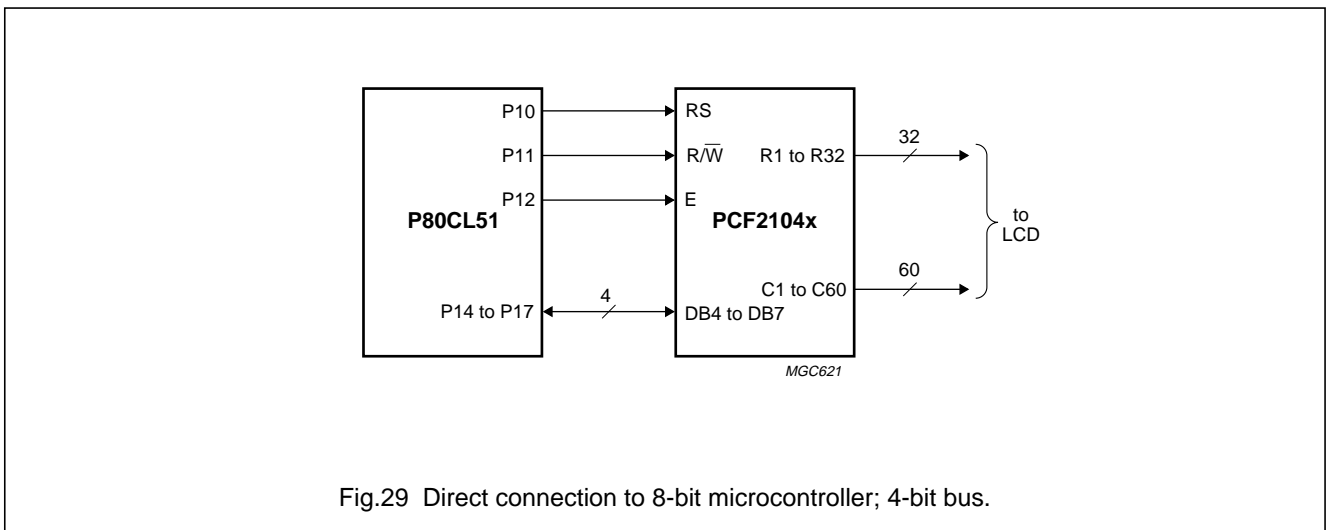

Fig.29 Direct connection to 8-bit microcontroller; 4-bit bus.

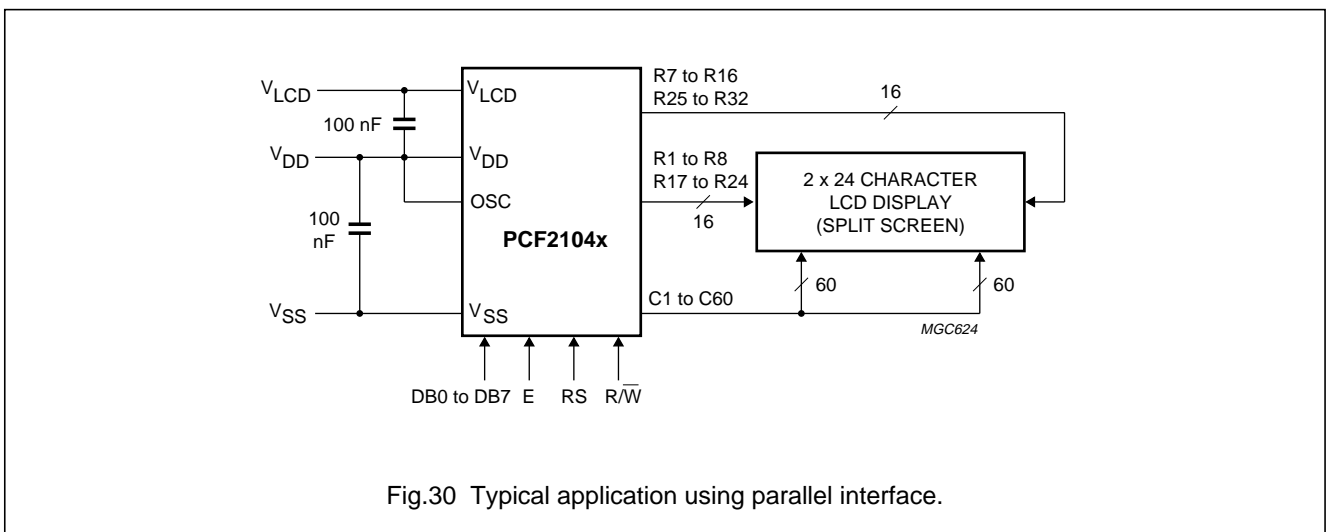

Fig.30 Typical application using parallel interface.

LCD controller/driver

PCF2104x

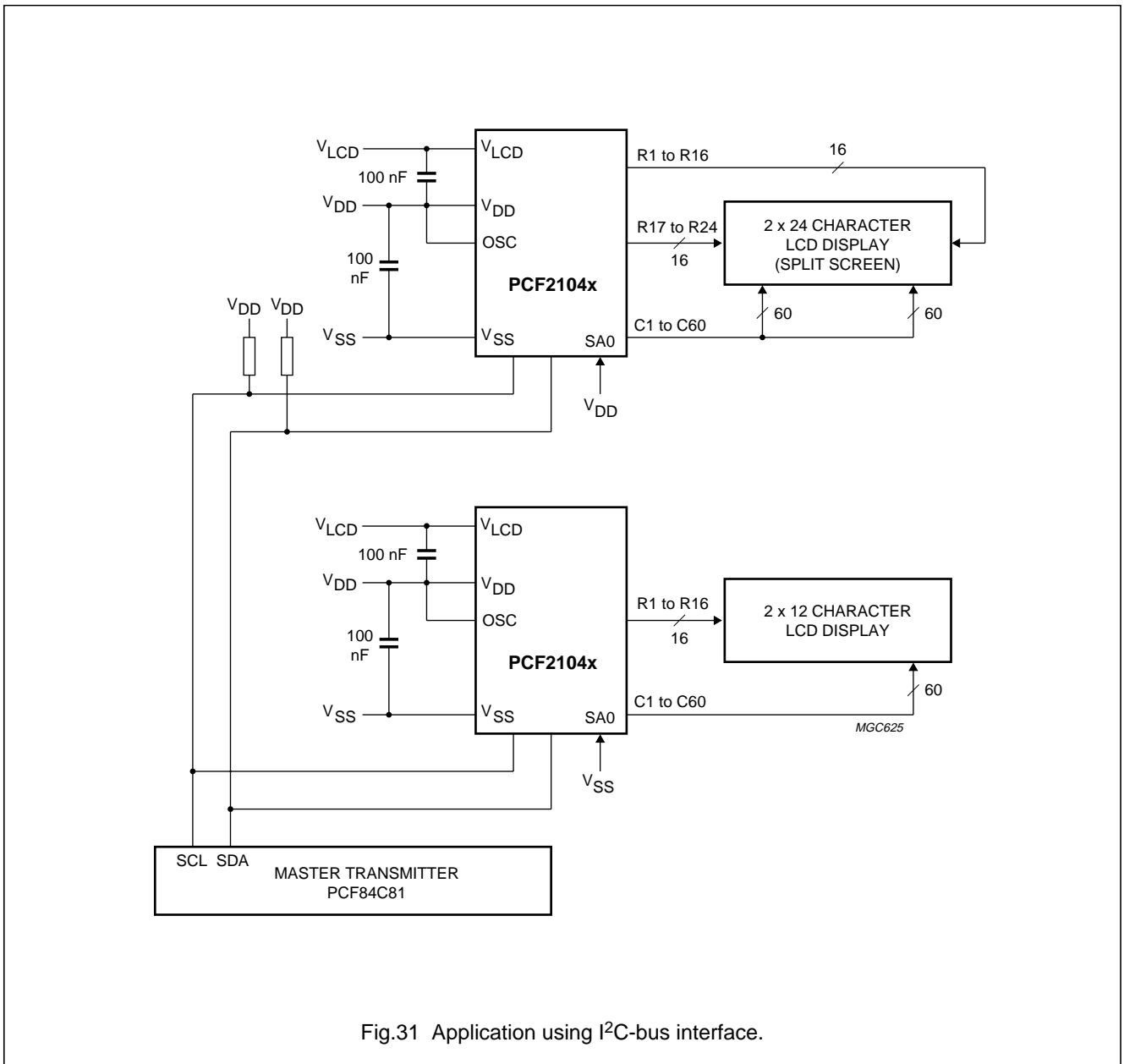

Fig.31 Application using I<sup>2</sup>C-bus interface.

## LCD controller/driver

## PCF2104x

**17.1 8-bit operation, 2 × 12 display using internal reset**

Table 7 shows an example of a 1-line display in 8-bit operation. The PCF2104x functions must be set by the function set instruction prior to display. Since the display data RAM can store data for 80 characters, the RAM can be used for advertising displays when combined with display shift operation. Since the display shift operation changes the display position only and DDRAM contents remain unchanged. Display data entered first can be displayed when the 'Return home' instruction is performed.

**17.2 4-bit operation, 2 × 12 display using internal reset**

The program must set functions prior to 4-bit operation. Table 6 shows an example. When power is turned on, 8-bit operation is automatically selected and the PCF2104x attempts to perform the first write as an 8-bit operation. Since nothing is connected to DB0 to DB3, a rewrite is then required. However, since one operation is completed in two accesses of 4-bit operation, a rewrite is required to set the functions (see Table 6 step 3).

Thus, DB4 to DB7 of the function set are written twice.

**17.3 8-bit operation, 2 × 24 display**

For a 2-line display, the cursor automatically moves from the first to the second line after the 40th digit of the first line has been written. Thus, if there are only 8 characters in the first line, the DDRAM address must be set after the eighth character is completed (see Table 8). It should be noted that both lines of the display are always shifted together, data does not shift from one line to the other.

**17.4 I<sup>2</sup>C operation, 2 × 12 display**

A control byte is required with most instructions (see Table 9).

**17.5 Initializing by instruction**

If the power supply conditions for correctly operating the internal reset circuit are not met, the PCF2104x must be initialized by instruction. Tables 10 and 11 show how this may be performed for 8-bit and 4-bit operation.

## LCD controller/driver

## PCF2104x

**Table 6** 4-bit operation, 1-line display example; using internal reset

STEP	INSTRUCTION	DISPLAY	OPERATION
1	Power supply on (PCF2104x is initialized by the internal reset circuit).		Initialized. No display appears.
2	Function set: RS = 0; R $\overline{W}$ = 0; DB7 = 0; DB6 = 0; DB5 = 1; DB4 = 0		Sets to 4-bit operation. In this instance operation is handled as 8-bits by initialization and only this instruction completes with one write.
3	Function set: RS = 0; R $\overline{W}$ = 0; DB7 = 0; DB6 = 0; DB5 = 1; DB4 = 0 RS = 0; R $\overline{W}$ = 0; DB7 = 0; DB6 = 0; DB5 = 0; DB4 = 0		Sets to 4-bit operation, selects 2 × 12 display.  4-bit operation starts from this point and resetting is needed.
4	Display on/off control: RS = 0; R $\overline{W}$ = 0; DB7 = 0; DB6 = 0; DB5 = 0; DB4 = 0 RS = 0; R $\overline{W}$ = 0; DB7 = 1; DB6 = 1; DB5 = 1; DB4 = 0		Turns on display and cursor.  Entire display is blank after initialization.
5	Entry mode set: RS = 0; R $\overline{W}$ = 0; DB7 = 0; DB6 = 0; DB5 = 0; DB4 = 0 RS = 0; R $\overline{W}$ = 0; DB7 = 0; DB6 = 1; DB5 = 1; DB4 = 0	_	Sets mode to increment the address by 1 and to shift the cursor to the right at the time of write to the DD/CGRAM. Display is not shifted.
6	Write data to CGRAM/DDRAM: RS = 1; R $\overline{W}$ = 0; DB7 = 0; DB6 = 1; DB5 = 0; DB4 = 1 RS = 1; R $\overline{W}$ = 0; DB7 = 0; DB6 = 1; DB5 = 1; DB4 = 0	P_	Writes 'P'. The DDRAM has already been selected by initialization at power-on.  The cursor is incremented by 1 and shifted to the right.

## LCD controller/driver

## PCF2104X

**Table 7** 8-bit operation, 1-line display example; using internal reset (character set 'A')

STEP	INSTRUCTION	DISPLAY	OPERATION
1	Power supply on (PCF2104x is initialized by the internal reset function).		Initialized. No display appears.
2	Function set: RS = 0; R/W = 0; DB7 = 0; DB6 = 0; DB5 = 1; DB4 = 1; DB3 = 0; DB2 = 0; DB1 = 0; DB0 = 0		Sets to 8-bit operation, selects 2 × 12 display.
3	Display mode on/off control: RS = 0; R/W = 0; DB7 = 0; DB6 = 0; DB5 = 0; DB4 = 0; DB3 = 1; DB2 = 1; DB1 = 1; DB0 = 0	–	Turns on display and cursor. Entire display is blank after initialization.
4	Entry mode set: RS = 0; R/W = 0; DB7 = 0; DB6 = 0; DB5 = 0; DB4 = 0; DB3 = 0; DB2 = 1; DB1 = 1; DB0 = 0	–	Sets mode to increment the address by 1 and to shift the cursor to the right at the time of the write to the DD/CGRAM. Display is not shifted.
5	Write data to CGRAM/DDRAM: RS = 1; R/W = 0; DB7 = 0; DB6 = 1; DB5 = 0; DB4 = 1; DB3 = 0; DB2 = 0; DB1 = 0; DB0 = 0	P_	Writes 'P'. The DDRAM has already been selected by initialization at power-on. The cursor is incremented by 1 and shifted to the right.
6	Write data to CGRAM/DDRAM: RS = 1; R/W = 0; DB7 = 0; DB6 = 1; DB5 = 1; DB4 = 1; DB3 = 1; DB2 = 0; DB1 = 0; DB0 = 0	PH_	Writes 'H'.
7			
8	Write data to CGRAM/DDRAM: RS = 1; R/W = 0; DB7 = 0; DB6 = 1; DB5 = 0; DB4 = 1; DB3 = 0; DB2 = 0; DB1 = 1; DB0 = 1	PHILIPS_	Writes 'S'.
9	Entry mode set: RS = 0; R/W = 0; DB7 = 0; DB6 = 0; DB5 = 0; DB4 = 0; DB3 = 0; DB2 = 1; DB1 = 1; DB0 = 1	PHILIPS_	Sets mode for display shift at the time of write.
10	Write data to CGRAM/DDRAM: RS = 1; R/W = 0; DB7 = 0; DB6 = 0; DB5 = 1; DB4 = 0; DB3 = 0; DB2 = 0; DB1 = 0; DB0 = 0	HILIPS_	Writes space.
11	Write data to CGRAM/DDRAM: RS = 1; R/W = 0; DB7 = 0; DB6 = 1; DB5 = 0; DB4 = 0; DB3 = 1; DB2 = 1; DB1 = 0; DB0 = 1	ILIPS M_	Writes 'M'.
12			

## LCD controller/driver

PCF2104X

STEP	INSTRUCTION	DISPLAY	OPERATION
13	Write data to CGRAM/DDRAM: RS = 1; R/W = 0; DB7 = 0; DB6 = 1; DB5 = 0; DB4 = 0; DB3 = 1; DB2 = 1; DB1 = 1; DB0 = 1	<b>MICROKO_</b>	Writes 'O'.
14	Cursor or display shift: RS = 0; R/W = 0; DB7 = 0; DB6 = 0; DB5 = 0; DB4 = 1; DB3 = 0; DB2 = 0; DB1 = 0; DB0 = 0	<b>MICROKO</b>	Shifts only the cursor position to the left.
15	Cursor or display shift: RS = 0; R/W = 0; DB7 = 0; DB6 = 0; DB5 = 0; DB4 = 1; DB3 = 0; DB2 = 0; DB1 = 0; DB0 = 0	<b>MICROKO</b>	Shifts only the cursor position to the left.
16	Write data to CGRAM/DDRAM: RS = 1; R/W = 0; DB7 = 0; DB6 = 1; DB5 = 0; DB4 = 0; DB3 = 0; DB2 = 0; DB1 = 1; DB0 = 1	<b>ICROCO</b>	Writes 'C' correction. The display moves to the left.
17	Cursor or display shift: RS = 0; R/W = 0; DB7 = 0; DB6 = 0; DB5 = 0; DB4 = 1; DB3 = 1; DB2 = 1; DB1 = 0; DB0 = 0	<b>MICROCO</b>	Shifts the display and cursor to the right.
18	Cursor or display shift: RS = 0; R/W = 0; DB7 = 0; DB6 = 0; DB5 = 0; DB4 = 1; DB3 = 0; DB2 = 1; DB1 = 0; DB0 = 0	<b>MICROCO_</b>	Shifts only the cursor to the right.
19	Write data to CGRAM/DDRAM: RS = 1; R/W = 0; DB7 = 0; DB6 = 1; DB5 = 0; DB4 = 0; DB3 = 1; DB2 = 1; DB1 = 0; DB0 = 1	<b>ICROCOM_</b>	Writes 'M'.
20			
21	Return home: RS = 0; R/W = 0; DB7 = 0; DB6 = 0; DB5 = 0; DB4 = 0; DB3 = 0; DB2 = 0; DB1 = 1; DB0 = 0	<b>PHILIPS M</b>	Returns both display and cursor to the original position (address 0).

## LCD controller/driver

## PCF2104X

**Table 8** 8-bit operation, 2-line display example; using internal reset

STEP	INSTRUCTION	DISPLAY	OPERATION
1	Power supply on (PCF2104x is initialized by the internal reset function).		Initialized. No display appears.
2	Function set: RS = 0; R/W = 0; DB7 = 0; DB6 = 0; DB5 = 1; DB4 = 1; DB3 = 1; DB2 = 0; DB1 = 0; DB0 = 0		Sets to 8-bit operation, selects 2 × 24 display
3	Display on/off control: RS = 0; R/W = 0; DB7 = 0; DB6 = 0; DB5 = 0; DB4 = 0; DB3 = 1; DB2 = 1; DB1 = 1; DB0 = 0	—	Turns on display and cursor. Entire display is blank after initialization.
4	Entry mode set: RS = 0; R/W = 0; DB7 = 0; DB6 = 0; DB5 = 0; DB4 = 0; DB3 = 0; DB2 = 1; DB1 = 1; DB0 = 0	—	Sets mode to increment the address by 1 and to shift the cursor to the right at the time of write to the CG/DDRAM. Display is not shifted.
5	Write data to CGRAM/DDRAM: RS = 1; R/W = 0; DB7 = 0; DB6 = 1; DB5 = 0; DB4 = 1; DB3 = 0; DB2 = 0; DB1 = 0; DB0 = 0	P_	Writes 'P'. The DDRAM has already been selected by initialization at power-on. The cursor is incremented by 1 and shifted to the right.
6			
7	Write data to CGRAM/DDRAM: RS = 1; R/W = 0; DB7 = 0; DB6 = 1; DB5 = 0; DB4 = 1; DB3 = 0; DB2 = 0; DB1 = 1; DB0 = 1	PHILIPS_	Writes 'S'.
8	Set DDRAM address: RS = 0; R/W = 0; DB7 = 1; DB6 = 1; DB5 = 0; DB4 = 0; DB3 = 0; DB2 = 0; DB1 = 0; DB0 = 0	PHILIPS —	Sets DDRAM address to position the cursor at the head of the 2nd line.
9	Write data to CGRAM/ DDRAM: RS = 1; R/W = 0; DB7 = 0; DB6 = 1; DB5 = 0; DB4 = 0; DB3 = 1; DB2 = 1; DB1 = 0; DB0 = 1	PHILIPS M_	Writes 'M'.
10			
11	Write data to CGRAM/ DDRAM: RS = 1; R/W = 0; DB7 = 0; DB6 = 1; DB5 = 0; DB4 = 0; DB3 = 1; DB2 = 1; DB1 = 1; DB0 = 1	PHILIPS MICROCO_	Writes 'O'.
12	Write data to CGRAM/ DDRAM: RS = 0; R/W = 0; DB7 = 0; DB6 = 0; DB5 = 0; DB4 = 0; DB3 = 0; DB2 = 1; DB1 = 1; DB0 = 1	PHILIPS MICROCO_	Sets mode for display shift at the time of write.



## LCD controller/driver

PCF2104X

STEP	INSTRUCTION	DISPLAY	OPERATION
13	Write data to CGRAM/ DDRAM: RS = 1; R/W = 0; DB7 = 0; DB6 = 1; DB5 = 0; DB4 = 0; DB3 = 1; DB2 = 1; DB1 = 0; DB0 = 1	HILIPS ICROCOM_	Writes 'M'. Display is shifted to the left. The first and second lines shift together.
14			
15	Return home: RS = 0; R/W = 0; DB7 = 0; DB6 = 0; DB5 = 0; DB4 = 0; DB3 = 0; DB2 = 0; DB1 = 1; DB0 = 0	PHILIPS MICROCOM	Returns both display and cursor to the original position (address 0).

## LCD controller/driver

## PCF2104X

**Table 9** Example of I<sup>2</sup>C-bus operation; 1-line display (using internal reset, assuming SA0 = V<sub>SS</sub>; note 1)

STEP	I <sup>2</sup> C-BUS BYTE	DISPLAY	OPERATION
1	I <sup>2</sup> C-bus start		Initialized. No display appears.
2	Slave address for write: SA6 = 0; SA5 = 1; SA4 = 1; SA3 = 1; SA2 = 0; SA1 = 1; SA0 = 0; R/W = 0; Ack = 1		During the acknowledge cycle SDA will be pulled-down by the PCF2104x.
3	Send a control byte for function set: Co = 0; RS = 0; R/W = 0; Ack = 1		Control byte sets RS and R/W for following data bytes.
4	Function set: DB7 = 0; DB6 = 0; DB5 = 1; DB4 = X; DB3 = 0; DB2 = 0; DB1 = 0; DB0 = 0; Ack = 1		Selects 1-line display; SCL pulse during acknowledge cycle starts execution of instruction.
5	Display on/off control: DB7 = 0; DB6 = 0; DB5 = 0; DB4 = 0; DB3 = 1; DB2 = 1; DB1 = 1; DB0 = 0; Ack = 1	–	Turns on display and cursor. Entire display shows character Hex 20 (blank in ASCII-like character sets).
6	Entry mode set: DB7 = 0; DB6 = 0; DB5 = 0; DB4 = 0; DB3 = 0; DB2 = 1; DB1 = 1; DB0 = 0; Ack = 1	–	Sets mode to increment the address by 1 and to shift the cursor to the right at the time of write to the DDRAM or CGRAM. Display is not shifted.
7	I <sup>2</sup> C-bus start	–	For writing data to DDRAM, RS must be set to 1. Therefore a control byte is needed.
8	Slave address for write: SA6 = 0; SA5 = 1; SA4 = 1; SA3 = 1; SA2 = 0; SA1 = 1; SA0 = 0; R/W = 0; Ack = 1	–	
9	Send a control byte for write data: Co = 0; RS = 1; R/W = 0; Ack = 1	–	
10	Write data to DDRAM: DB7 = 0; DB6 = 1; DB5 = 0; DB4 = 1; DB3 = 0; DB2 = 0; DB1 = 0; DB0 = 0; Ack = 1	P_	Writes 'P'. The DDRAM has been selected at power-up. The cursor is incremented by 1 and shifted to the right.
11	Write data to DDRAM: DB7 = 0; DB6 = 1; DB5 = 0; DB4 = 0; DB3 = 1; DB2 = 0; DB1 = 0; DB0 = 0; Ack = 1	PH_	Writes 'H'.
12 to 15		—	
16	Write data to DDRAM: DB7 = 0; DB6 = 1; DB5 = 0; DB4 = 1; DB3 = 0; DB2 = 0; DB1 = 1; DB0 = 1; Ack = 1	PHILIPS_	Writes 'S'.

## LCD controller/driver

PCF2104X

STEP	I <sup>2</sup> C-BUS BYTE	DISPLAY	OPERATION
17	(optional I <sup>2</sup> C-bus stop) I <sup>2</sup> C-bus start + slave address for write (as step 8)	PHILIPS_	
18	Control byte: Co = 1; RS = 0; R/W = 0; Ack = 1	PHILIPS_	
19	Return home: DB7 = 0; DB6 = 0; DB5 = 0; DB4 = 0; DB3 = 0; DB2 = 0; DB1 = 1; DB0 = 0; Ack = 1	PHILIPS	Sets DDRAM address 0 in Address Counter. (Also returns shifted display to original position. DDRAM contents unchanged). This instruction does not update the Data Register (DR).
20	Control byte for read: Co = 0; RS = 1; R/W = 1; Ack = 1	PHILIPS	DDRAM content will be read from following instructions. The R/W has to be set to 1 while still in I <sup>2</sup> C-bus write mode.
21	I <sup>2</sup> C-bus start	PHILIPS	
22	Slave address for read: SA6 = 0; SA5 = 1; SA4 = 1; SA3 = 1; SA2 = 0; SA1 = 1; SA0 = 0; R/W = 1; Ack = 1	PHILIPS	During the acknowledge cycle the content of the DR is loaded into the internal I <sup>2</sup> C-bus interface to be shifted out. In the previous instruction neither a 'Set address' nor a 'Read data' has been performed. Therefore the content of the DR was unknown.
23	Read data: 8 × SCL + master acknowledge; note 2: DB7 = X; DB6 = X; DB5 = X; DB4 = X; DB3 = X; DB2 = X; DB1 = X; DB0 = X; Ack = 1	PHILIPS	8 × SCL; content loaded into interface during previous acknowledge cycle is shifted out over SDA. MSB is DB7. During master acknowledge content of DDRAM address 01 is loaded into the I <sup>2</sup> C-bus interface.
24	Read data: 8 × SCL + master acknowledge; note 2: DB7 = 0; DB6 = 1; DB5 = 0; DB4 = 0; DB3 = 1; DB2 = 0; DB1 = 0; DB0 = 0; Ack = 0	PHILIPS	8 × SCL; code of letter 'H' is read first. During master acknowledge code of 'I' is loaded into the I <sup>2</sup> C-bus interface.
25	Read data: 8 × SCL + no master acknowledge; note 2: DB7 = 0; DB6 = 1; DB5 = 0; DB4 = 0; DB3 = 1; DB2 = 0; DB1 = 0; DB0 = 1; Ack = 1	PHILIPS	No master acknowledge; After the content of the I <sup>2</sup> C-bus interface register is shifted out no internal action is performed. No new data is loaded to the interface register, Data Register (DR) is not updated, Address Counter (AC) is not incremented and cursor is not shifted.
26	I <sup>2</sup> C stop	PHILIPS	

## Notes

1. X = don't care.
2. SDA is left at high-impedance by the microcontroller during the READ acknowledge.

## LCD controller/driver

## PCF2104X

**Table 10** Initialization by instruction, 8-bit interface (note 1)

STEP	DESCRIPTION
Power-on or unknown state	
Wait 2 ms after $V_{DD}$ rises above $V_{POR}$	
RS = 0; $R/\overline{W}$ = 0; DB7 = 0; DB6 = 0; DB5 = 1; DB4 = 1; DB3 = X; DB2 = X; DB1 = X; DB0 = X	BF cannot be checked before this instruction. 'Function set' (interface is 8-bits long).
Wait 2 ms	
RS = 0; $R/\overline{W}$ = 0; DB7 = 0; DB6 = 0; DB5 = 1; DB4 = 1; DB3 = X; DB2 = X; DB1 = X; DB0 = X	BF cannot be checked before this instruction. 'Function set' (interface is 8-bits long).
Wait more than 40 $\mu$ s	
RS = 0; $R/\overline{W}$ = 0; DB7 = 0; DB6 = 0; DB5 = 1; DB4 = 1; DB3 = X; DB2 = X; DB1 = X; DB0 = X	BF cannot be checked before this instruction. 'Function set' (interface is 8-bits long).
	BF can be checked after the following instructions. When BF is not checked, the waiting time between instructions is the specified instruction time (see Table 3).
RS = 0; $R/\overline{W}$ = 0; DB7 = 0; DB6 = 0; DB5 = 1; DB4 = 1; DB3 = N; DB2 = M; DB1 = X; DB0 = 0	'Function set' (interface is 8-bits long). Specify the number of display lines.
RS = 0; $R/\overline{W}$ = 0; DB7 = 0; DB6 = 0; DB5 = 0; DB4 = 0; DB3 = 1; DB2 = 0; DB1 = 0; DB0 = 0	'Display off'.
RS = 0; $R/\overline{W}$ = 0; DB7 = 0; DB6 = 0; DB5 = 0; DB4 = 0; DB3 = 0; DB2 = 0; DB1 = 0; DB0 = 1	'Clear display'.
RS = 0; $R/\overline{W}$ = 0; DB7 = 0; DB6 = 0; DB5 = 0; DB4 = 0; DB3 = 0; DB2 = 1; DB1 = I/D; DB0 = S	'Entry mode set'.
Initialization ends	

**Note**

1. X = don't care.

## LCD controller/driver

## PCF2104X

**Table 11** Initialization by instruction, 4-bit interface. Not applicable for I<sup>2</sup>C-bus operation

STEP	DESCRIPTION
Power-on or unknown state	
Wait 2 ms after V <sub>DD</sub> rises above V <sub>POR</sub>	
RS = 0; R $\overline{W}$ = 0; DB7 = 0; DB6 = 0; DB5 = 1; DB4 = 1	BF cannot be checked before this instruction. 'Function set' (interface is 8-bits long).
Wait 2 ms	
RS = 0; R $\overline{W}$ = 0; DB7 = 0; DB6 = 0; DB5 = 1; DB4 = 1	BF cannot be checked before this instruction. 'Function set' (interface is 8-bits long).
Wait 40 $\mu$ s	
RS = 0; R $\overline{W}$ = 0; DB7 = 0; DB6 = 0; DB5 = 1; DB4 = 1	BF cannot be checked before this instruction. 'Function set' (interface is 8-bits long).
	BF can be checked after the following instructions. When BF is not checked, the waiting time between instructions is the specified instruction time (see Table 3).
RS = 0; R $\overline{W}$ = 0; DB7 = 0; DB6 = 0; DB5 = 1; DB4 = 0	'Function set' (set interface to 4-bits long). Interface is 8-bits long.
RS = 0; R $\overline{W}$ = 0; DB7 = 0; DB6 = 0; DB5 = 1; DB4 = 0	'Function set' (interface is 4-bits long).
RS = 0; R $\overline{W}$ = 0; DB7 = N; DB6 = M; DB5 = 0; DB4 = 0	Specify number of display lines and voltage generator characteristic.
RS = 0; R $\overline{W}$ = 0; DB7 = 0; DB6 = 0; DB5 = 0; DB4 = 0	'Display off'.
RS = 0; R $\overline{W}$ = 0; DB7 = 1; DB6 = 0; DB5 = 0; DB4 = 0	
RS = 0; R $\overline{W}$ = 0; DB7 = 0; DB6 = 0; DB5 = 0; DB4 = 0	'Clear display'.
RS = 0; R $\overline{W}$ = 0; DB7 = 1; DB6 = 0; DB5 = 0; DB4 = 0	
RS = 0; R $\overline{W}$ = 0; DB7 = 0; DB6 = 0; DB5 = 0; DB4 = 0	'Entry mode set'.
RS = 0; R $\overline{W}$ = 0; DB7 = 0; DB6 = 1; DB5 = I/D; DB4 = S	
Initialization ends	

LCD controller/driver

PCF2104x

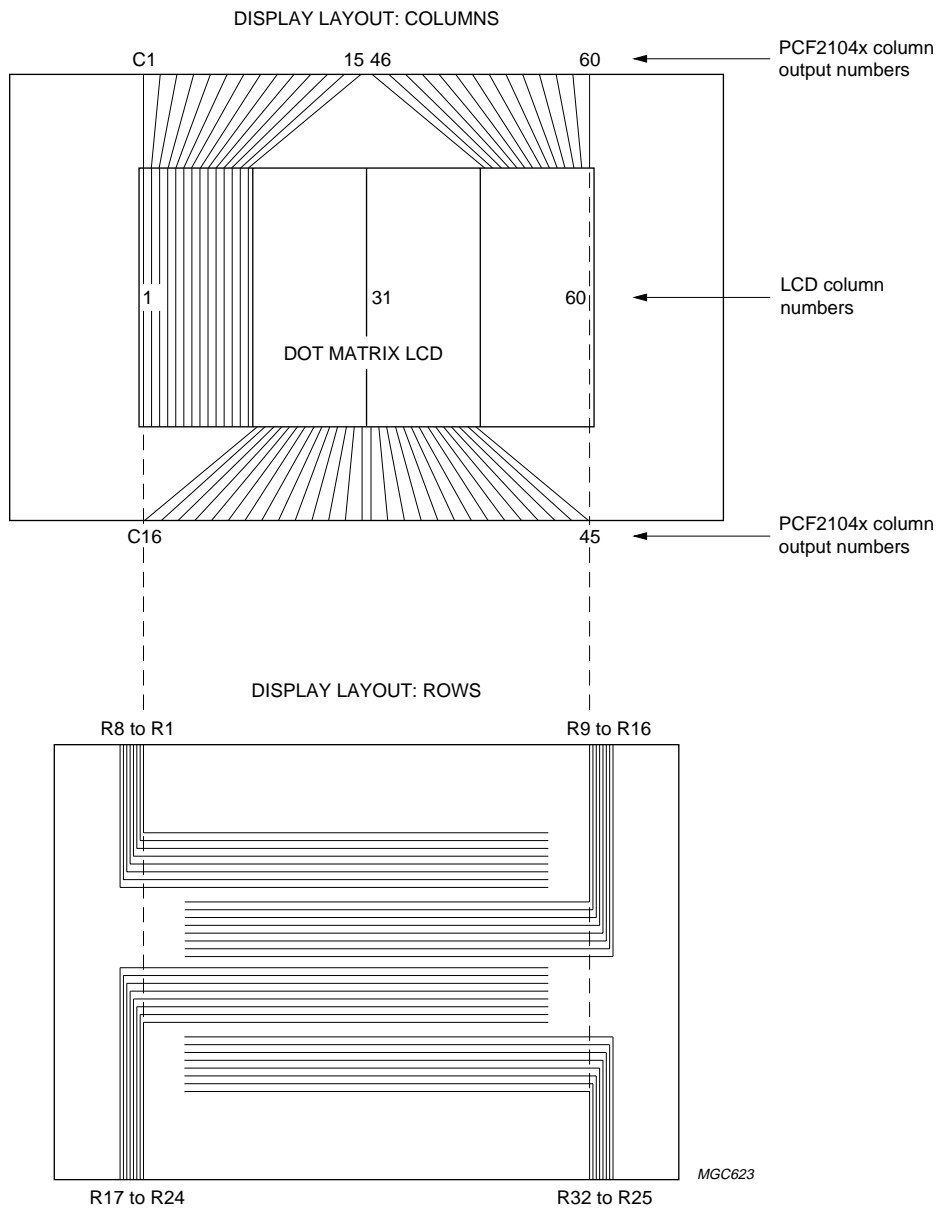
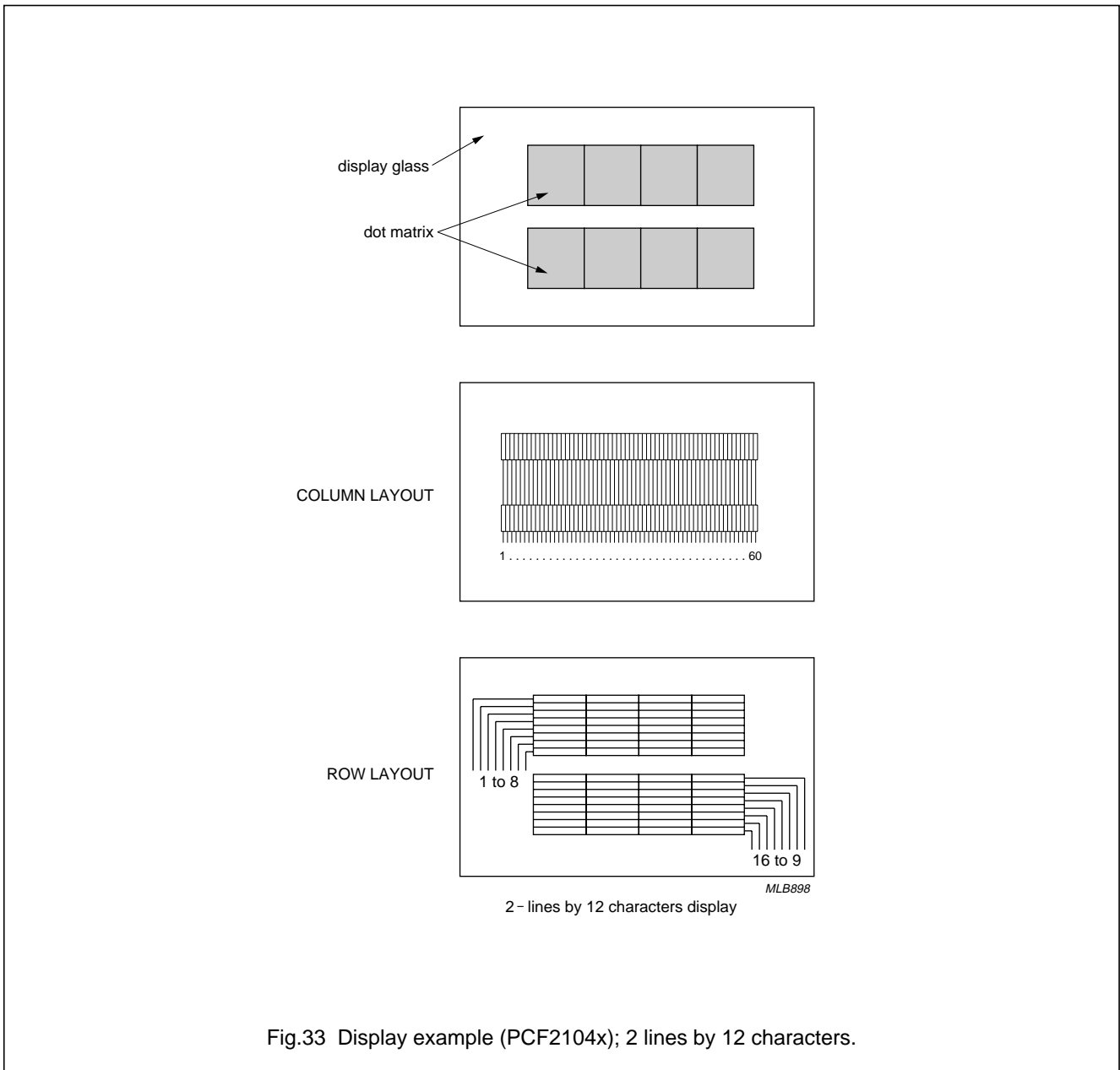

Fig.32 Example of 4 × 12 display layout (PCF2104x).

LCD controller/driver

PCF2104x



LCD controller/driver

PCF2104x

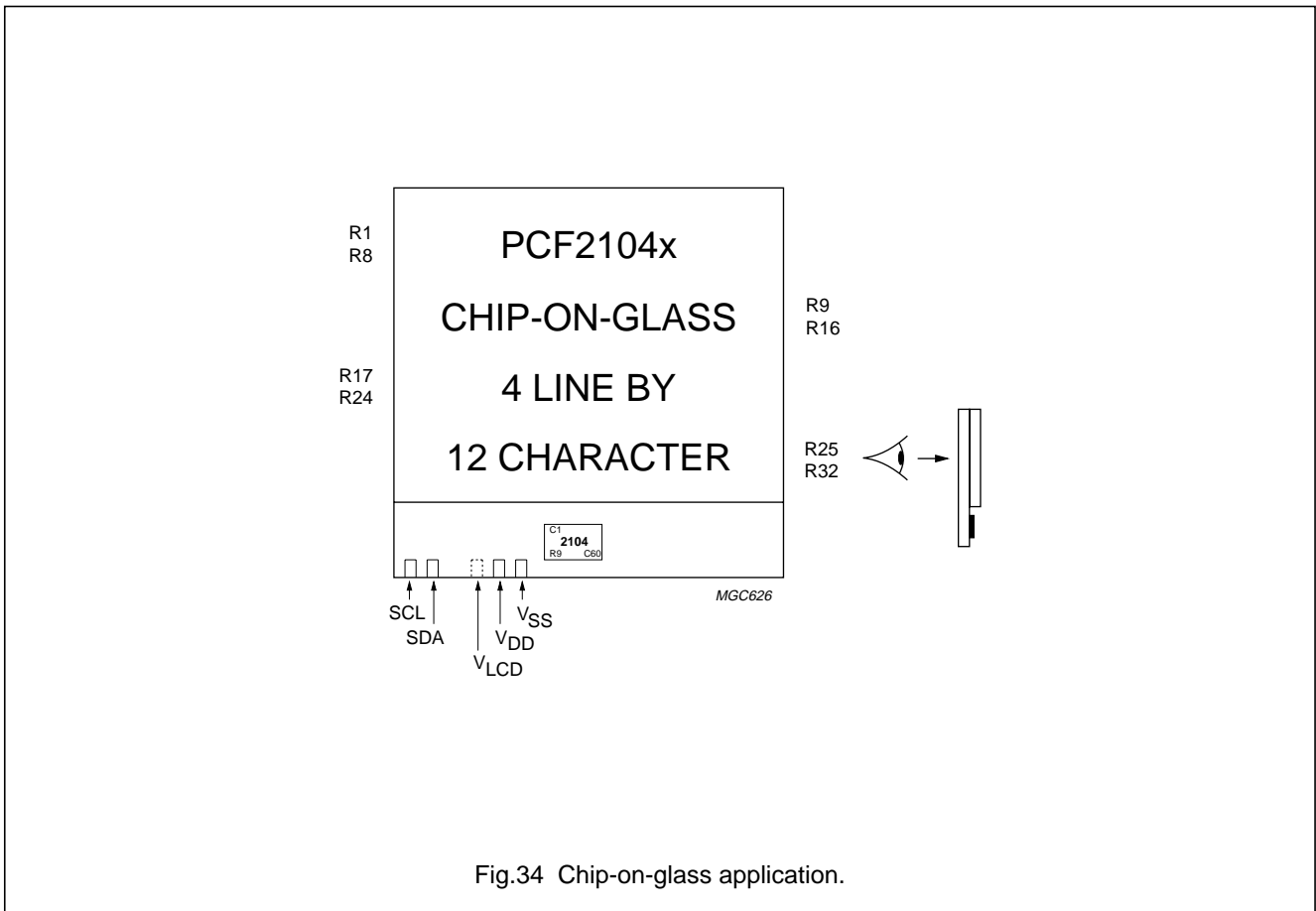

Fig.34 Chip-on-glass application.



LCD controller/driver

PCF2104x

18 BONDING PAD LOCATIONS

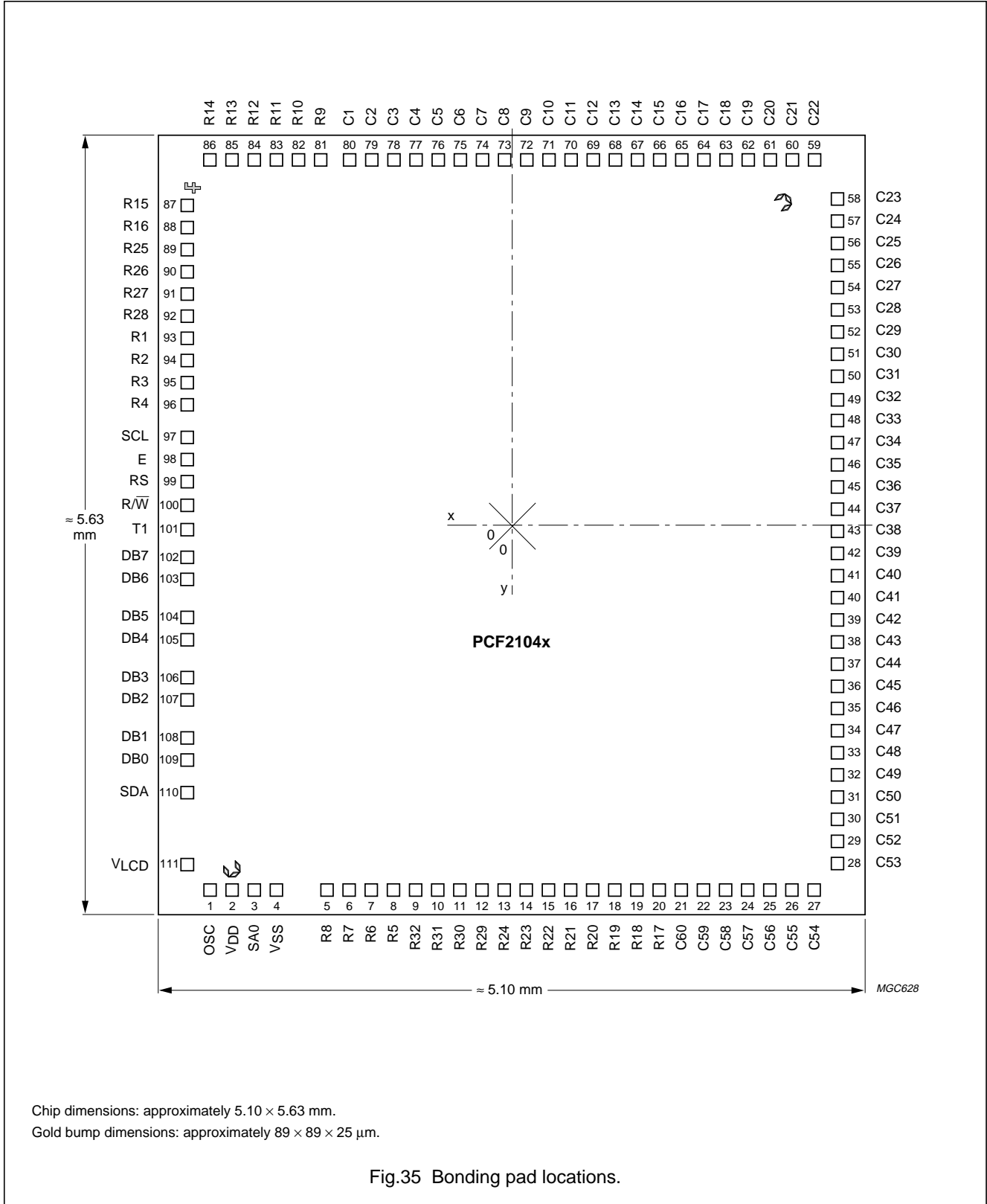

Fig.35 Bonding pad locations.

## LCD controller/driver

## PCF2104x

**Table 12** Bonding pad locations (dimensions in  $\mu\text{m}$ ).

All x/y coordinates are referenced to centre of chip,  
see Fig.35

SYMBOL	PAD	x	y
OSC	1	-2184.5	-2637
V <sub>DD</sub>	2	-2024.5	-2637
SA0	3	-1864.5	-2637
V <sub>SS</sub>	4	-1704.5	-2637
R8	5	-1339	-2637
R7	6	-1179	-2637
R6	7	-1019	-2637
R5	8	-859	-2637
R32	9	-699	-2637
R31	10	-539	-2637
R30	11	-379	-2637
R29	12	-219	-2637
R24	13	-59	-2637
R23	14	101	-2637
R22	15	261	-2637
R21	16	421	-2637
R20	17	581	-2637
R19	18	741	-2637
R18	19	901	-2637
R17	20	1061	-2637
C60	21	1221	-2637
C59	22	1381	-2637
C58	23	1541	-2637
C57	24	1701	-2637
C56	25	1861	-2637
C55	26	2021	-2637
C54	27	2181	-2637
C53	28	2350	-2445
C52	29	2350	-2285
C51	30	2350	-2125
C50	31	2350	-1965
C49	32	2350	-1805
C48	33	2350	-1645
C47	34	2350	-1485
C46	35	2350	-1325
C45	36	2350	-1165
C44	37	2350	-1005
C43	38	2350	-845

SYMBOL	PAD	x	y
C42	39	2350	-685
C41	40	2350	-525
C40	41	2350	-365
C39	42	2350	-205
C38	43	2350	-45
C37	44	2350	115
C36	45	2350	275
C35	46	2350	435
C34	47	2350	595
C33	48	2350	755
C32	49	2350	915
C31	50	2350	1075
C30	51	2350	1235
C29	52	2350	1395
C28	53	2350	1555
C27	54	2350	1715
C26	55	2350	1875
C25	56	2350	2035
C24	57	2350	2195
C23	58	2350	2355
C22	59	2185	2637.5
C21	60	2025	2637.5
C20	61	1865	2637.5
C19	62	1705	2637.5
C18	63	1545	2637.5
C17	64	1385	2637.5
C16	65	1225	2637.5
C15	66	1065	2637.5
C14	67	905	2637.5
C13	68	745	2637.5
C12	69	585	2637.5
C11	70	425	2637.5
C10	71	265	2637.5
C9	72	105	2637.5
C8	73	-55	2637.5
C7	74	-215	2637.5
C6	75	-375	2637.5
C5	76	-535	2637.5

## LCD controller/driver

## PCF2104x

SYMBOL	PAD	x	y
C4	77	-695	2637.5
C3	78	-855	2637.5
C2	79	-1015	2637.5
C1	80	-1175	2637.5
R9	81	-1385	2637.5
R10	82	-1545	2637.5
R11	83	-1705	2637.5
R12	84	-1865	2637.5
R13	85	-2025	2637.5
R14	86	-2185	2637.5
R15	87	-2349	2308
R16	88	-2349	2148
R25	89	-2349	1988
R26	90	-2349	1828
R27	91	-2349	1668
R28	92	-2349	1508
R1	93	-2349	1348
R2	94	-2349	1188
R3	95	-2349	1028
R4	96	-2349	868
SCL	97	-2349	632
E	98	-2349	472
RS	99	-2349	312
R $\bar{W}$	100	-2349	142
T1	101	-2349	-34
DB7	102	-2349	-233
DB6	103	-2349	-393
DB5	104	-2349	-668
DB4	105	-2349	-828
DB3	106	-2349	-1103
DB2	107	-2349	-1263
DB1	108	-2349	-1538
DB0	109	-2349	-1698
SDA	110	-2349	-1933
V <sub>LCD</sub>	111	-2349	-2453
RECPAT 'F'		-2327.5	2427.5
RECPAT 'C'		-2027.5	-2512.5
RECPAT 'C'		1982.5	2297.5

## LCD controller/driver

## PCF2104x

**19 DEFINITIONS**

<b>Data sheet status</b>	
Objective specification	This data sheet contains target or goal specifications for product development.
Preliminary specification	This data sheet contains preliminary data; supplementary data may be published later.
Product specification	This data sheet contains final product specifications.
<b>Limiting values</b>	
Limiting values given are in accordance with the Absolute Maximum Rating System (IEC 134). Stress above one or more of the limiting values may cause permanent damage to the device. These are stress ratings only and operation of the device at these or at any other conditions above those given in the Characteristics sections of the specification is not implied. Exposure to limiting values for extended periods may affect device reliability.	
<b>Application information</b>	
Where application information is given, it is advisory and does not form part of the specification.	

**20 LIFE SUPPORT APPLICATIONS**

These products are not designed for use in life support appliances, devices, or systems where malfunction of these products can reasonably be expected to result in personal injury. Philips customers using or selling these products for use in such applications do so at their own risk and agree to fully indemnify Philips for any damages resulting from such improper use or sale.

**21 PURCHASE OF PHILIPS I<sup>2</sup>C COMPONENTS**

Purchase of Philips I<sup>2</sup>C components conveys a license under the Philips' I<sup>2</sup>C patent to use the components in the I<sup>2</sup>C system provided the system conforms to the I<sup>2</sup>C specification defined by Philips. This specification can be ordered using the code 9398 393 40011.

LCD controller/driver

PCF2104x

---

**NOTES**

LCD controller/driver

PCF2104x

---

**NOTES**

LCD controller/driver

PCF2104x

---

**NOTES**

# Philips Semiconductors – a worldwide company

**Argentina:** see South America

**Australia:** 34 Waterloo Road, NORTH RYDE, NSW 2113,  
Tel. +61 2 9805 4455, Fax. +61 2 9805 4466

**Austria:** Computerstr. 6, A-1101 WIEN, P.O. Box 213,  
Tel. +43 1 60 101, Fax. +43 1 60 101 1210

**Belarus:** Hotel Minsk Business Center, Bld. 3, r. 1211, Volodarski Str. 6,  
220050 MINSK, Tel. +375 172 200 733, Fax. +375 172 200 773

**Belgium:** see The Netherlands

**Brazil:** see South America

**Bulgaria:** Philips Bulgaria Ltd., Energoproject, 15th floor,  
51 James Bourchier Blvd., 1407 SOFIA,  
Tel. +359 2 689 211, Fax. +359 2 689 102

**Canada:** PHILIPS SEMICONDUCTORS/COMPONENTS,  
Tel. +1 800 234 7381

**China/Hong Kong:** 501 Hong Kong Industrial Technology Centre,  
72 Tat Chee Avenue, Kowloon Tong, HONG KONG,  
Tel. +852 2319 7888, Fax. +852 2319 7700

**Colombia:** see South America

**Czech Republic:** see Austria

**Denmark:** Prags Boulevard 80, PB 1919, DK-2300 COPENHAGEN S,  
Tel. +45 32 88 2636, Fax. +45 31 57 1949

**Finland:** Sinikalliontie 3, FIN-02630 ESPOO,  
Tel. +358 9 615800, Fax. +358 9 61580/xxx

**France:** 4 Rue du Port-aux-Vins, BP317, 92156 SURESNES Cedex,  
Tel. +33 1 40 99 6161, Fax. +33 1 40 99 6427

**Germany:** Hammerbrookstraße 69, D-20097 HAMBURG,  
Tel. +49 40 23 53 60, Fax. +49 40 23 536 300

**Greece:** No. 15, 25th March Street, GR 17778 TAVROS/ATHENS,  
Tel. +30 1 4894 339/239, Fax. +30 1 4814 240

**Hungary:** see Austria

**India:** Philips INDIA Ltd, Shivsagar Estate, A Block, Dr. Annie Besant Rd.  
Worli, MUMBAI 400 018, Tel. +91 22 4938 541, Fax. +91 22 4938 722

**Indonesia:** see Singapore

**Ireland:** Newstead, Clonskeagh, DUBLIN 14,  
Tel. +353 1 7640 000, Fax. +353 1 7640 200

**Israel:** RAPAC Electronics, 7 Kehilat Saloniki St, TEL AVIV 61180,  
Tel. +972 3 645 0444, Fax. +972 3 649 1007

**Italy:** PHILIPS SEMICONDUCTORS, Piazza IV Novembre 3,  
20124 MILANO, Tel. +39 2 6752 2531, Fax. +39 2 6752 2557

**Japan:** Philips Bldg 13-37, Kohnan 2-chome, Minato-ku, TOKYO 108,  
Tel. +81 3 3740 5130, Fax. +81 3 3740 5077

**Korea:** Philips House, 260-199 Itaewon-dong, Yongsan-ku, SEOUL,  
Tel. +82 2 709 1412, Fax. +82 2 709 1415

**Malaysia:** No. 76 Jalan Universiti, 46200 PETALING JAYA, SELANGOR,  
Tel. +60 3 750 5214, Fax. +60 3 757 4880

**Mexico:** 5900 Gateway East, Suite 200, EL PASO, TEXAS 79905,  
Tel. +9-5 800 234 7381

**Middle East:** see Italy

**Netherlands:** Postbus 90050, 5600 PB EINDHOVEN, Bldg. VB,  
Tel. +31 40 27 82785, Fax. +31 40 27 88399

**New Zealand:** 2 Wagener Place, C.P.O. Box 1041, AUCKLAND,  
Tel. +64 9 849 4160, Fax. +64 9 849 7811

**Norway:** Box 1, Manglerud 0612, OSLO,  
Tel. +47 22 74 8000, Fax. +47 22 74 8341

**Philippines:** Philips Semiconductors Philippines Inc.,  
106 Valero St. Salcedo Village, P.O. Box 2108 MCC, MAKATI,  
Metro MANILA, Tel. +63 2 816 6380, Fax. +63 2 817 3474

**Poland:** Ul. Lukiska 10, PL 04-123 WARSZAWA,  
Tel. +48 22 612 2831, Fax. +48 22 612 2327

**Portugal:** see Spain

**Romania:** see Italy

**Russia:** Philips Russia, Ul. Usatcheva 35A, 119048 MOSCOW,  
Tel. +7 095 755 6918, Fax. +7 095 755 6919

**Singapore:** Lorong 1, Toa Payoh, SINGAPORE 1231,  
Tel. +65 350 2538, Fax. +65 251 6500

**Slovakia:** see Austria

**Slovenia:** see Italy

**South Africa:** S.A. PHILIPS Pty Ltd., 195-215 Main Road Martindale,  
2092 JOHANNESBURG, P.O. Box 7430 Johannesburg 2000,  
Tel. +27 11 470 5911, Fax. +27 11 470 5494

**South America:** Rua do Rocio 220, 5th floor, Suite 51,  
04552-903 São Paulo, SÃO PAULO - SP, Brazil,  
Tel. +55 11 821 2333, Fax. +55 11 829 1849

**Spain:** Balmes 22, 08007 BARCELONA,  
Tel. +34 3 301 6312, Fax. +34 3 301 4107

**Sweden:** Kottbygatan 7, Akalla, S-16485 STOCKHOLM,  
Tel. +46 8 632 2000, Fax. +46 8 632 2745

**Switzerland:** Allmendstrasse 140, CH-8027 ZÜRICH,  
Tel. +41 1 488 2686, Fax. +41 1 481 7730

**Taiwan:** Philips Semiconductors, 6F, No. 96, Chien Kuo N. Rd., Sec. 1,  
TAIPEI, Taiwan Tel. +886 2 2134 2870, Fax. +886 2 2134 2874

**Thailand:** PHILIPS ELECTRONICS (THAILAND) Ltd.,  
209/2 Sanpavuth-Bangna Road Prakanong, BANGKOK 10260,  
Tel. +66 2 745 4090, Fax. +66 2 398 0793

**Turkey:** Talatpasa Cad. No. 5, 80640 GÜLTEPE/ISTANBUL,  
Tel. +90 212 279 2770, Fax. +90 212 282 6707

**Ukraine:** PHILIPS UKRAINE, 4 Patrice Lumumba str., Building B, Floor 7,  
252042 KIEV, Tel. +380 44 264 2776, Fax. +380 44 268 0461

**United Kingdom:** Philips Semiconductors Ltd., 276 Bath Road, Hayes,  
MIDDLESEX UB3 5BX, Tel. +44 181 730 5000, Fax. +44 181 754 8421

**United States:** 811 East Arques Avenue, SUNNYVALE, CA 94088-3409,  
Tel. +1 800 234 7381

**Uruguay:** see South America

**Vietnam:** see Singapore

**Yugoslavia:** PHILIPS, Trg N. Pasica 5/v, 11000 BEOGRAD,  
Tel. +381 11 625 344, Fax. +381 11 635 777

**For all other countries apply to:** Philips Semiconductors, Marketing & Sales Communications,  
Building BE-p, P.O. Box 218, 5600 MD EINDHOVEN, The Netherlands, Fax. +31 40 27 24825

**Internet:** <http://www.semiconductors.philips.com>

© Philips Electronics N.V. 1997

SCA53

All rights are reserved. Reproduction in whole or in part is prohibited without the prior written consent of the copyright owner.

The information presented in this document does not form part of any quotation or contract, is believed to be accurate and reliable and may be changed without notice. No liability will be accepted by the publisher for any consequence of its use. Publication thereof does not convey nor imply any license under patent- or other industrial or intellectual property rights.

Printed in The Netherlands

417067/1200/04/pp56

Date of release: 1997 Dec 16

Document order number: 9397 750 02924

*Let's make things better.*

**Philips  
Semiconductors**



**PHILIPS**