

DATA SHEET

PCF8578

LCD row/column driver for dot
matrix graphic displays

Product specification
Supersedes data of 1996 Oct 28
File under Integrated Circuits, IC12

1997 Mar 28

LCD row/column driver for dot matrix graphic displays

PCF8578

CONTENTS	18	SOLDERING
1	FEATURES	18.1 Introduction
2	APPLICATIONS	18.2 Reflow soldering
3	GENERAL DESCRIPTION	18.3 Wave soldering
4	ORDERING INFORMATION	18.3.1 LQFP
5	BLOCK DIAGRAM	18.3.2 VSO
6	PINNING	18.3.3 Method (LQFP and VSO)
7	FUNCTIONAL DESCRIPTION	18.4 Repairing soldered joints
7.1	Mixed mode	19
7.2	Row mode	20
7.3	Multiplexed LCD bias generation	21
7.4	Power-on reset	
7.5	Internal clock	
7.6	External clock	
7.7	Timing generator	
7.8	Row/column drivers	
7.9	Display mode controller	
7.10	Display RAM	
7.11	Data pointer	
7.12	Subaddress counter	
7.13	I ² C-bus controller	
7.14	Input filters	
7.15	RAM access	
7.16	Display control	
7.17	TEST pin	
8	I ² C-BUS PROTOCOL	
8.1	Command decoder	
9	CHARACTERISTICS OF THE I ² C-BUS	
9.1	Bit transfer	
9.2	Start and stop conditions	
9.3	System configuration	
9.4	Acknowledge	
10	LIMITING VALUES	
11	HANDLING	
12	DC CHARACTERISTICS	
13	AC CHARACTERISTICS	
14	APPLICATION INFORMATION	
15	CHIP DIMENSIONS AND BONDING PAD LOCATIONS	
16	CHIP-ON GLASS INFORMATION	
17	PACKAGE OUTLINE	



LCD row/column driver for dot matrix graphic displays

PCF8578

1 FEATURES

- Single chip LCD controller/driver
- Stand-alone or may be used with up to 32 PCF8579s (40960 dots possible)
- 40 driver outputs, configurable as $32/8$, $24/16$, $16/24$ or $8/32$ rows/columns
- Selectable multiplex rates; 1 : 8, 1 : 16, 1 : 24 or 1 : 32
- Externally selectable bias configuration, 5 or 6 levels
- 1280-bit RAM for display data storage and scratch pad
- Display memory bank switching
- Auto-incremented data loading across hardware subaddress boundaries (with PCF8579)
- Provides display synchronization for PCF8579
- On-chip oscillator, requires only 1 external resistor
- Power-on reset blanks display
- Logic voltage supply range 2.5 to 6 V
- Maximum LCD supply voltage 9 V
- Low power consumption
- I²C-bus interface
- TTL/CMOS compatible
- Compatible with most microcontrollers
- Optimized pinning for single plane wiring in multiple device applications (with PCF8579)
- Space saving 56-lead plastic mini-pack and 64 pin quad flat pack
- Compatible with chip-on-glass technology.

2 APPLICATIONS

- Automotive information systems
- Telecommunication systems
- Point-of-sale terminals
- Computer terminals
- Instrumentation.

3 GENERAL DESCRIPTION

The PCF8578 is a low power CMOS LCD row/column driver, designed to drive dot matrix graphic displays at multiplex rates of 1 : 8, 1 : 16, 1 : 24 or 1 : 32. The device has 40 outputs, of which 24 are programmable, configurable as $32/8$, $24/16$, $16/24$ or $8/32$ rows/columns. The PCF8578 can function as a stand-alone LCD controller/driver for use in small systems, or for larger systems can be used in conjunction with up to 32 PCF8579s for which it has been optimized. Together these two devices form a general purpose LCD dot matrix driver chip set, capable of driving displays of up to 40960 dots. The PCF8578 is compatible with most microcontrollers and communicates via a two-line bidirectional bus (I²C-bus). Communication overheads are minimized by a display RAM with auto-incremented addressing and display bank switching.

4 ORDERING INFORMATION

TYPE NUMBER	PACKAGE		
	NAME	DESCRIPTION	VERSION
PCF8578T	VSO56	plastic very small outline package; 56 leads	SOT190-1
PCF8578U7	–	chip with bumps on tape	–
PCF8578H	LQFP64	plastic low profile quad flat package; 64 leads; body 10 × 10 × 1.4 mm	SOT314-2

LCD row/column driver for dot matrix graphic displays

PCF8578

5 BLOCK DIAGRAM

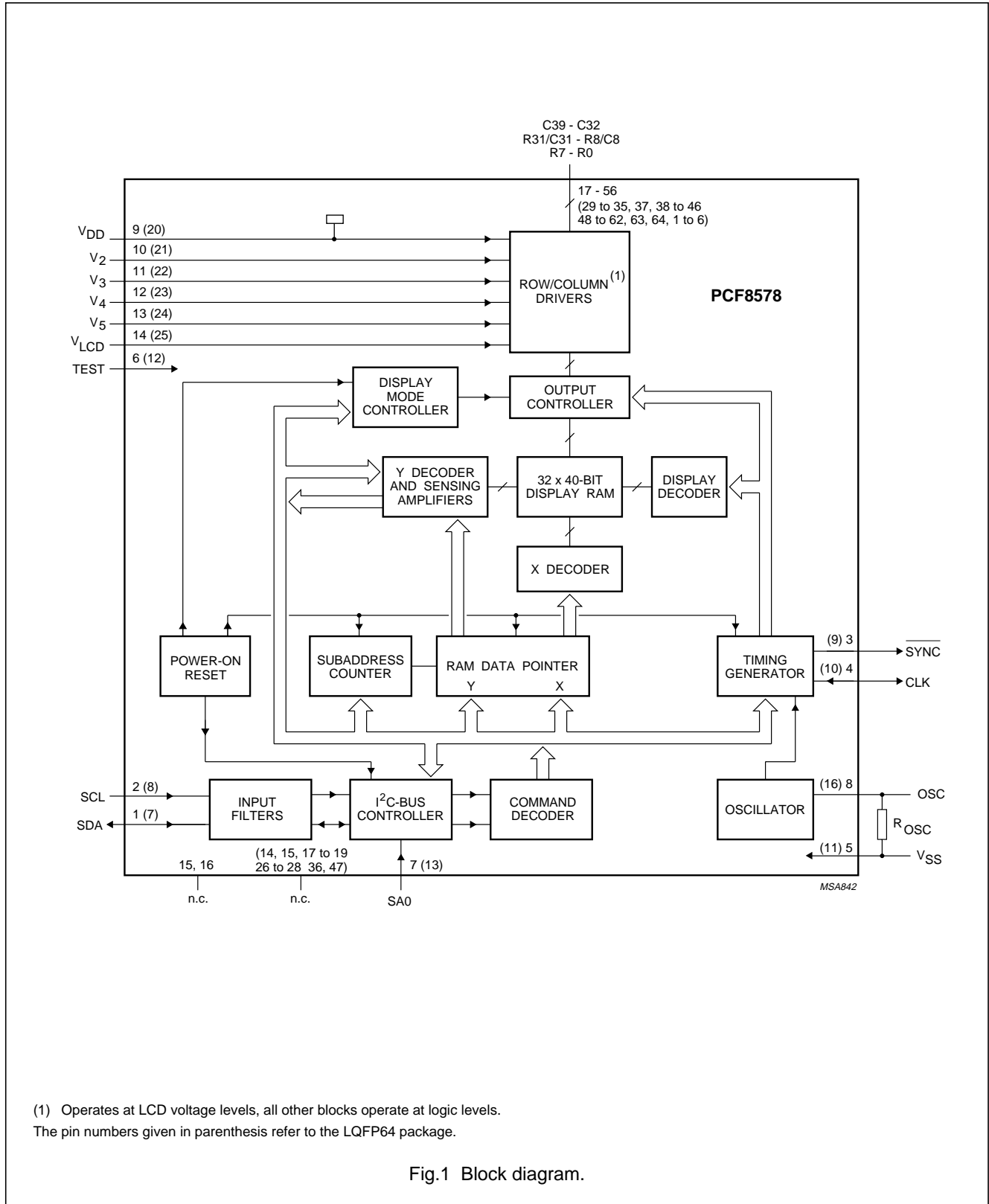

LCD row/column driver for dot matrix graphic displays

PCF8578

6 PINNING

SYMBOL	PIN		DESCRIPTION
	VSO56	LQFP64	
SDA	1	7	I ² C-bus serial data input/output
SCL	2	8	I ² C-bus serial clock input
$\overline{\text{SYNC}}$	3	9	cascade synchronization output
CLK	4	10	external clock input/output
V _{SS}	5	11	ground (logic)
TEST	6	12	test pin (connect to V _{SS})
SA0	7	13	I ² C-bus slave address input (bit 0)
OSC	8	16	oscillator input
V _{DD}	9	20	positive supply voltage
V ₂ to V ₅	10 to 13	21 to 24	LCD bias voltage inputs
V _{LCD}	14	25	LCD supply voltage
n.c.	15, 16	14, 15, 17 to 19, 26 to 28, 36, 47	not connected
C39 to C32	17 to 24	29 to 35, 37	LCD column driver outputs
R31/C31 to R8/C8	25 to 48	38 to 46, 48 to 62	LCD row/column driver outputs
R7 to R0	49 to 56	63, 64, 1 to 6	LCD row driver outputs

LCD row/column driver for dot matrix graphic displays

PCF8578

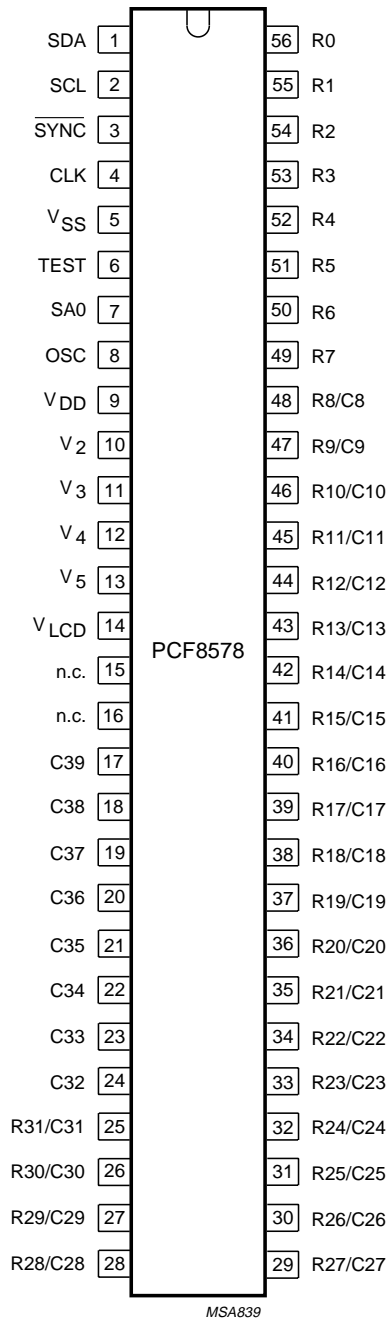

Fig.2 Pin configuration (VSO56).

LCD row/column driver for dot matrix graphic displays

PCF8578

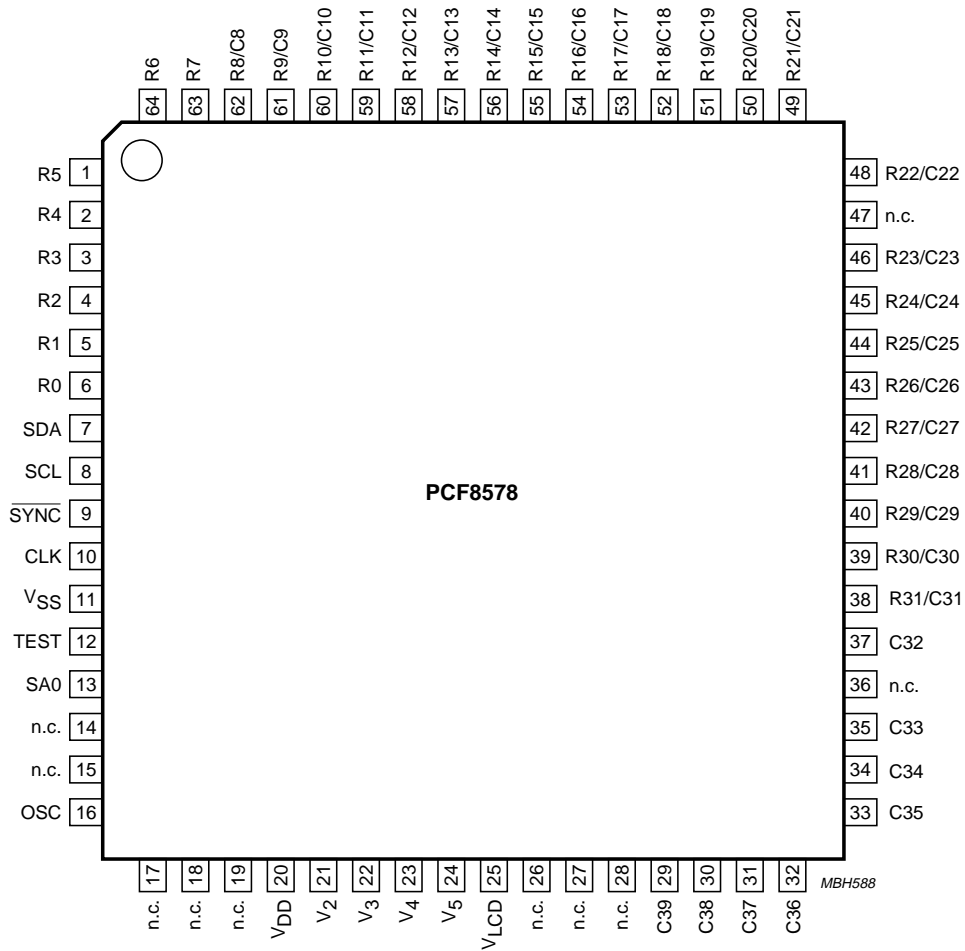

Fig.3 Pin configuration (LQFP64).

LCD row/column driver for dot matrix graphic displays

PCF8578

7 FUNCTIONAL DESCRIPTION

The PCF8578 row/column driver is designed for use in one of three ways:

- Stand-alone row/column driver for small displays (mixed mode)
- Row/column driver with cascaded PCF8579s (mixed mode)
- Row driver with cascaded PCF8579s (mixed mode).

7.1 Mixed mode

In mixed mode, the device functions as both a row and column driver. It can be used in small stand-alone applications, or for larger displays with up to 15 PCF8579s (31 PCF8579s when two slave addresses are used). See Table 1 for common display configurations.

7.2 Row mode

In row mode, the device functions as a row driver with up to 32 row outputs and provides the clock and synchronization signals for the PCF8579. Up to 16 PCF8579s can normally be cascaded (32 when two slave addresses are used).

Timing signals are derived from the on-chip oscillator, whose frequency is determined by the value of the resistor connected between OSC and V_{SS} .

Commands sent on the I²C-bus from the host microcontroller set the mode (row or mixed), configuration (multiplex rate and number of rows and columns) and control the operation of the device. The device may have one of two slave addresses. The only difference between these slave addresses is the least significant bit, which is set by the logic level applied to SA0. The PCF8578 and PCF8579 also have subaddresses. The subaddress of the PCF8578 is only defined in mixed mode and is fixed at 0. The RAM may only be accessed in mixed mode and data is loaded as described for the PCF8579.

Bias levels may be generated by an external potential divider with appropriate decoupling capacitors. For large displays, bias sources with high drive capability should be used. A typical mixed mode system operating with up to 15 PCF8579s is shown in Fig.5 (a stand-alone system would be identical but without the PCF8579s).

Table 1 Possible displays configurations

APPLICATION	MULTIPLEX RATE	MIXED MODE		ROW MODE		TYPICAL APPLICATIONS
		ROWS	COLUMNS	ROWS	COLUMNS	
Stand alone	1 : 8	8	32	–	–	small digital or alphanumerical displays
	1 : 16	16	24	–	–	
	1 : 24	24	16	–	–	
	1 : 32	32	8	–	–	
With PCF8579	1 : 8	8 ⁽¹⁾	632 ⁽¹⁾	8 × 4 4 ⁽²⁾	640 ⁽²⁾	alphanumeric displays and dot matrix graphic displays
	1 : 16	16 ⁽¹⁾	624 ⁽¹⁾	16 × 2 ⁽²⁾	640 ⁽²⁾	
	1 : 24	24 ⁽¹⁾	616 ⁽¹⁾	24 ⁽²⁾	640 ⁽²⁾	
	1 : 32	32 ⁽¹⁾	608 ⁽¹⁾	24 ⁽²⁾	640 ⁽²⁾	

Notes

1. Using 15 PCF8579s.
2. Using 16 PCF8579s.

LCD row/column driver for dot matrix graphic displays

PCF8578

7.3 Multiplexed LCD bias generation

The bias levels required to produce maximum contrast depend on the multiplex rate and the LCD threshold voltage (V_{th}). V_{th} is typically defined as the RMS voltage at which the LCD exhibits 10% contrast. Table 2 shows the optimum voltage bias levels for the PCF8578 as functions of V_{op} ($V_{op} = V_{DD} - V_{LCD}$), together with the discrimination ratios (D) for the different multiplex rates. A practical value for V_{op} is obtained by equating $V_{off(rms)}$ with V_{th} . Figure 4 shows the first 4 rows of Table 2 as graphs. Table 3 shows the relative values of the resistors required in the configuration of Fig.5 to produce the standard multiplex rates.

Table 2 Optimum LCD voltages

PARAMETER	MULTIPLEX RATE			
	1 : 8	1 : 16	1 : 24	1 : 32
$\frac{V_2}{V_{op}}$	0.739	0.800	0.830	0.850
$\frac{V_3}{V_{op}}$	0.522	0.600	0.661	0.700
$\frac{V_4}{V_{op}}$	0.478	0.400	0.339	0.300
$\frac{V_5}{V_{op}}$	0.261	0.200	0.170	0.150
$\frac{V_{off(rms)}}{V_{op}}$	0.297	0.245	0.214	0.193
$\frac{V_{on(rms)}}{V_{op}}$	0.430	0.316	0.263	0.230
$D = \frac{V_{on(rms)}}{V_{off(rms)}}$	1.447	1.291	1.230	1.196
$\frac{V_{op}}{V_{th}}$	3.370	4.080	4.680	5.190

Table 3 Multiplex rates and resistor values for Fig.5

RESISTORS	MULTIPLEX RATE (n)	
	n = 8	n = 16, 24, 32
R1	R	R
R2	$(\sqrt{n-2}) R$	R
R3	$(3 - \sqrt{n}) R$	$(\sqrt{n-3}) R$

7.4 Power-on reset

At power-on the PCF8578 resets to a defined starting condition as follows:

1. Display blank
2. 1 : 32 multiplex rate, row mode
3. Start bank, 0 selected
4. Data pointer is set to X, Y address 0, 0
5. Character mode
6. Subaddress counter is set to 0
7. I²C-bus interface is initialized.

Data transfers on the I²C-bus should be avoided for 1 ms following power-on, to allow completion of the reset action.

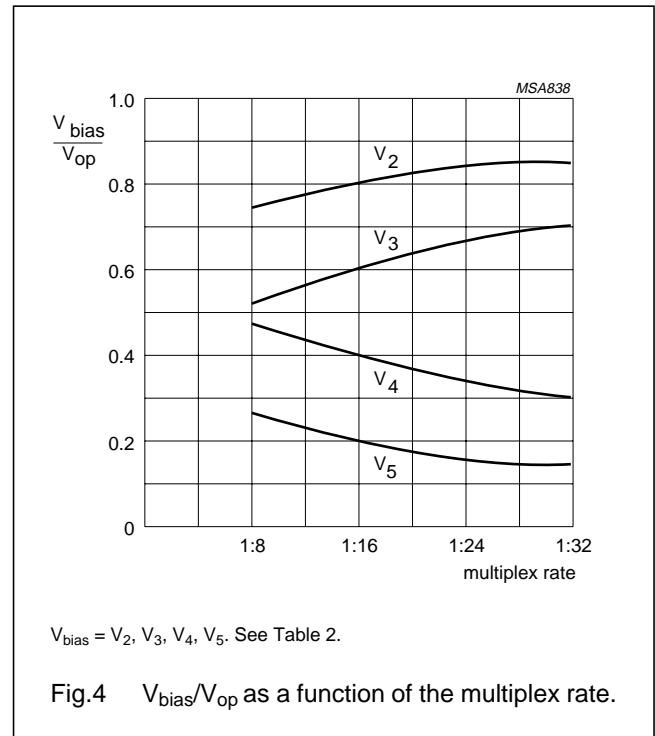

LCD row/column driver for dot matrix graphic displays

PCF8578

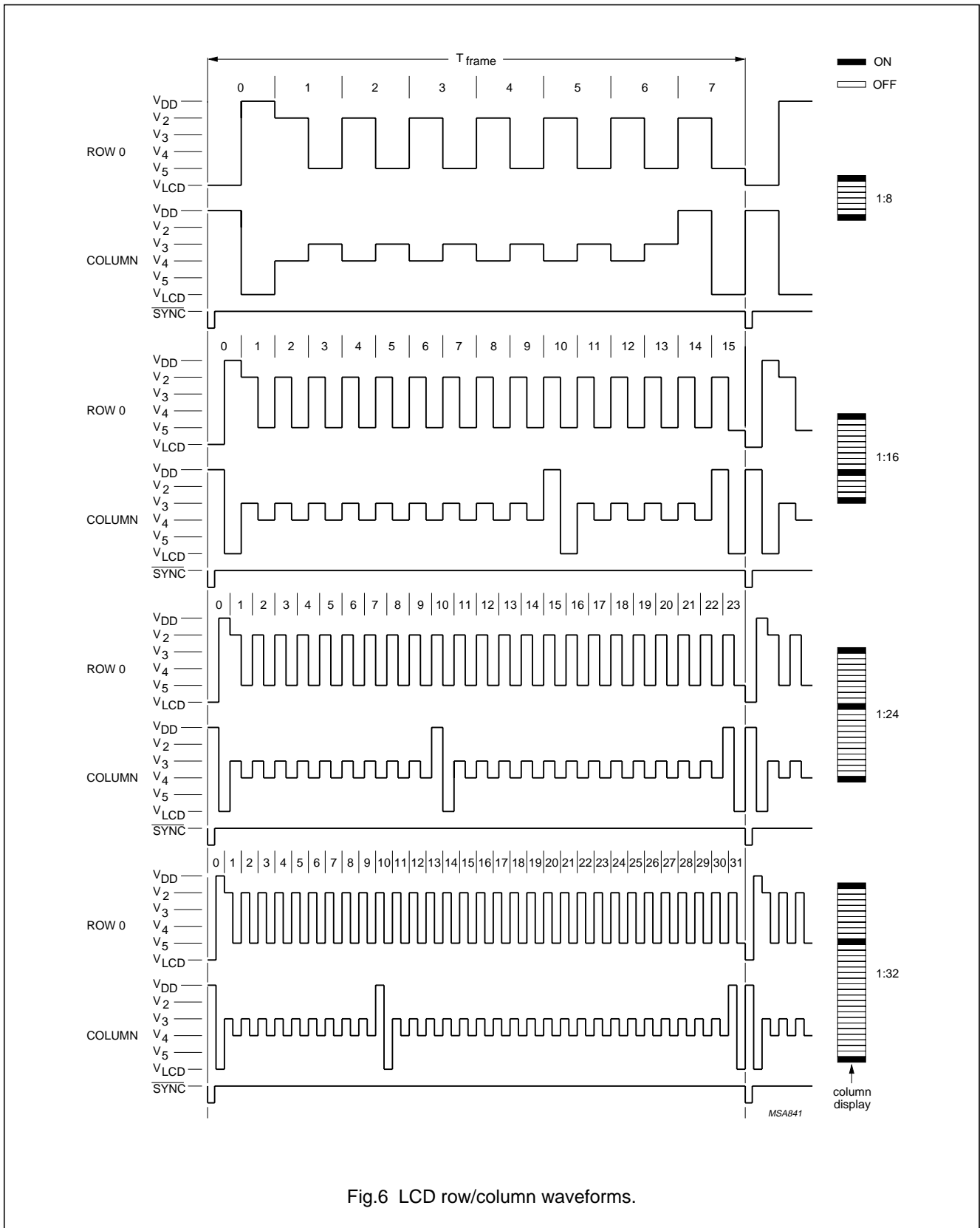
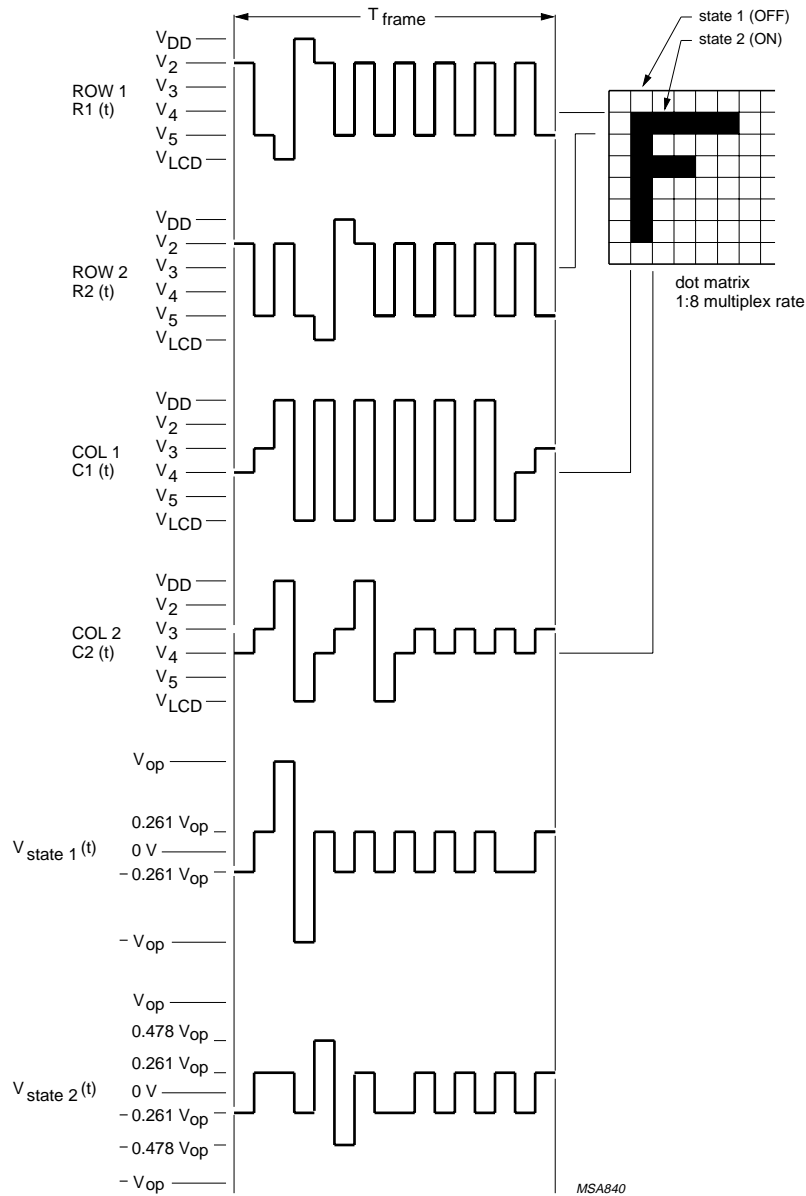

Fig.6 LCD row/column waveforms.

LCD row/column driver for dot matrix graphic displays

PCF8578



MSA840

$$V_{state 1}(t) = C1(t) - R1(t):$$

$$\frac{V_{on(rms)}}{V_{op}} = \sqrt{\frac{1}{8} + \frac{\sqrt{8}-1}{8(\sqrt{8}+1)}} = 0.430$$

$$V_{state 2}(t) = C2(t) - R2(t):$$

$$\frac{V_{off(rms)}}{V_{op}} = \sqrt{\frac{2(\sqrt{8}-1)}{\sqrt{8}(\sqrt{8}+1)^2}} = 0.297$$

general relationship (n = multiplex rate)

$$\frac{V_{on(rms)}}{V_{op}} = \sqrt{\frac{1}{n} + \frac{\sqrt{n}-1}{n(\sqrt{n}+1)}}$$

$$\frac{V_{off(rms)}}{V_{op}} = \sqrt{\frac{2(\sqrt{n}-1)}{\sqrt{n}(\sqrt{n}+1)^2}}$$

Fig.7 LCD drive mode waveforms for 1 : 8 multiplex rate.

LCD row/column driver for dot matrix graphic displays

PCF8578

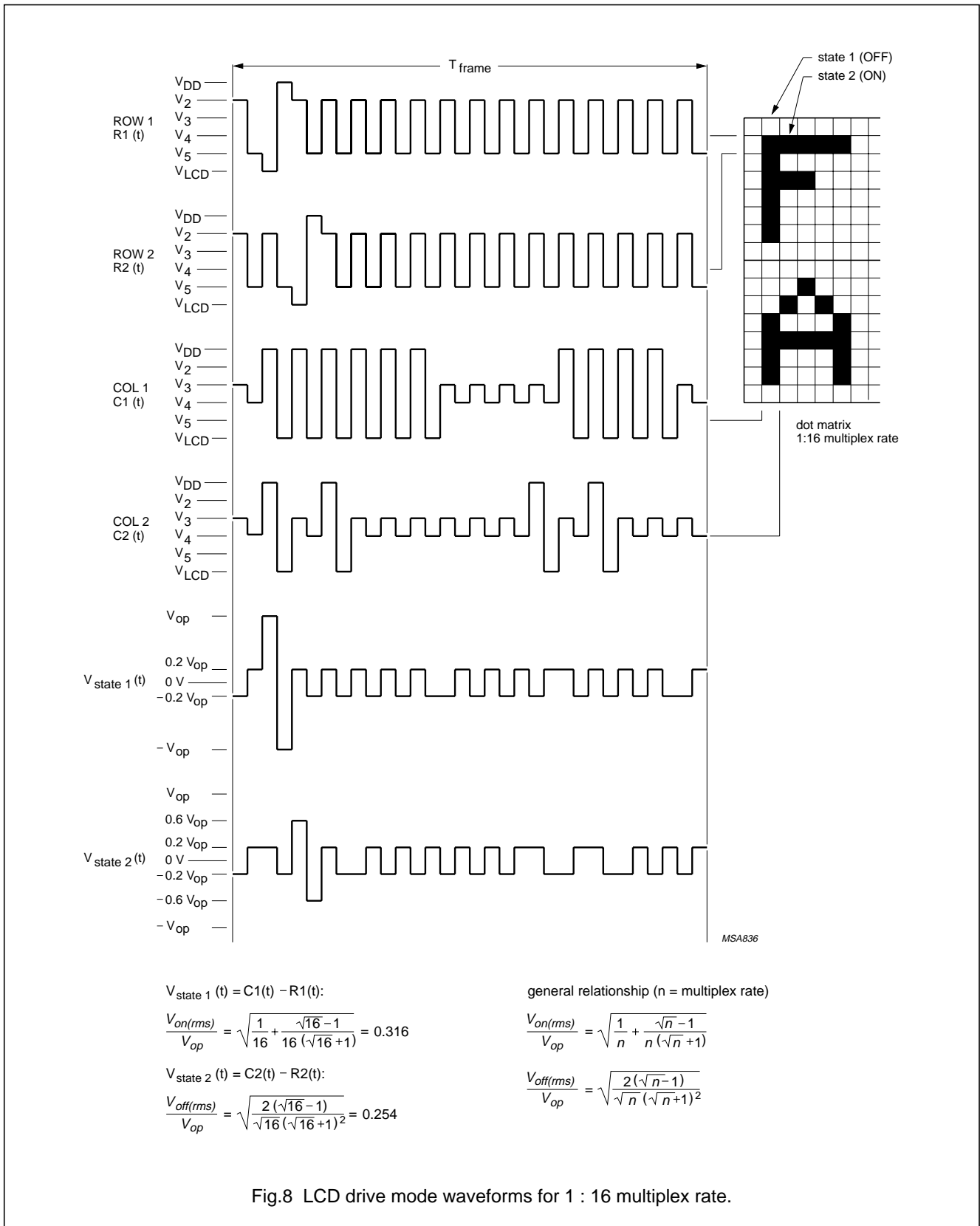

Fig.8 LCD drive mode waveforms for 1 : 16 multiplex rate.

LCD row/column driver for dot matrix graphic displays

PCF8578

7.5 Internal clock

The clock signal for the system may be generated by the internal oscillator and prescaler. The frequency is determined by the value of the resistor R_{OSC} , see Fig.9. For normal use a value of 330 k Ω is recommended. The clock signal, for cascaded PCF8579s, is output at CLK and has a frequency $\frac{1}{6}$ (multiplex rate 1 : 8, 1 : 16 and 1 : 32) or $\frac{1}{8}$ (multiplex rate 1 : 24) of the oscillator frequency.

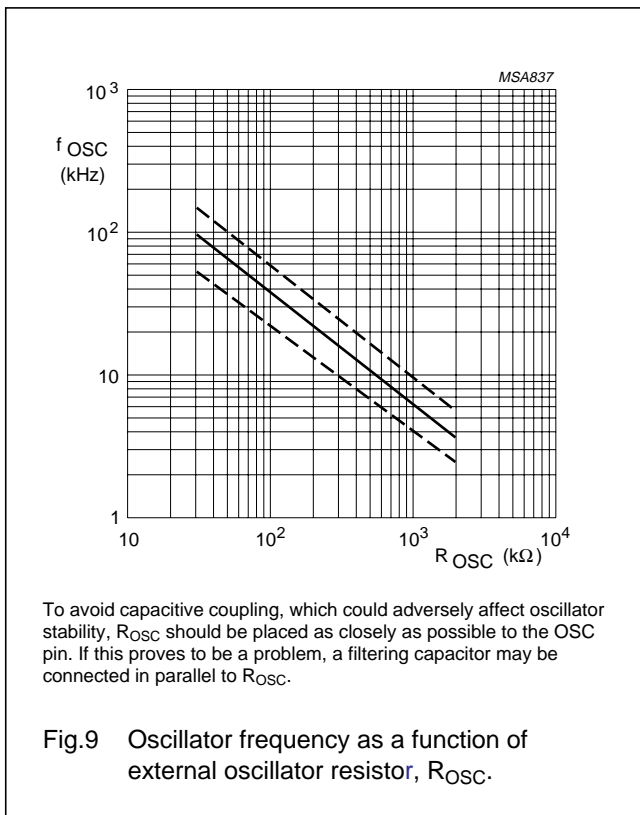

7.6 External clock

If an external clock is used, OSC must be connected to V_{DD} and the external clock signal to CLK. Table 4 summarizes the nominal CLK and \overline{SYNC} frequencies.

7.7 Timing generator

The timing generator of the PCF8578 organizes the internal data flow of the device and generates the LCD frame synchronization pulse \overline{SYNC} , whose period is an integer multiple of the clock period. In cascaded applications, this signal maintains the correct timing relationship between the PCF8578 and PCF8579s in the system.

7.8 Row/column drivers

Outputs R0 to R7 and C32 to C39 are fixed as row and column drivers respectively. The remaining 24 outputs R8/C8 to R31/C31 are programmable and may be configured (in blocks of 8) to be either row or column drivers. The row select signal is produced sequentially at each output from R0 up to the number defined by the multiplex rate (see Table 1). In mixed mode the remaining outputs are configured as columns. In row mode all programmable outputs (R8/C8 to R31/C31) are defined as row drivers and the outputs C32 to C39 should be left open-circuit.

Using a 1 : 16 multiplex rate, two sets of row outputs are driven, thus facilitating split-screen configurations, i.e. a row select pulse appears simultaneously at R0 and R16/C16, R1 and R17/C17 etc. Similarly, using a multiplex rate of 1 : 8, four sets of row outputs are driven simultaneously. Driver outputs must be connected directly to the LCD. Unused outputs should be left open-circuit. In 1 : 8 R0 to R7 are rows; in 1 : 16 R0 to R15/C15 are rows; in 1 : 24 R0 to R23/C23 are rows; in 1 : 32 R0 to R31/C31 are rows.

Table 4 Signal frequencies required for nominal 64 Hz frame frequency; note 1.

OSCILLATOR FREQUENCY $f_{OSC}^{(2)}$ (Hz)	FRAME FREQUENCY $f_{\overline{SYNC}}$ (Hz)	MULTIPLEX RATE (n)	DIVISION RATIO	CLOCK FREQUENCY f_{CLK} (Hz)
12288	64	1 : 8, 1 : 16, 1 : 32	6	2048
12288	64	1 : 24	8	1536

Notes

1. A clock signal must always be present, otherwise the LCD may be frozen in a DC state.
2. $R_{OSC} = 330$ k Ω .

LCD row/column driver for dot matrix graphic displays

PCF8578

7.9 Display mode controller

The configuration of the outputs (row or column) and the selection of the appropriate driver waveforms are controlled by the display mode controller.

7.10 Display RAM

The PCF8578 contains a 32 x 40-bit static RAM which stores the display data. The RAM is divided into 4 banks of 40 bytes (4 x 8 x 40 bits). During RAM access, data is transferred to/from the RAM via the I²C-bus. The first eight columns of data (0 to 7) cannot be displayed but are available for general data storage and provide compatibility with the PCF8579. There is a direct correspondence between X-address and column output number.

7.11 Data pointer

The addressing mechanism for the display RAM is realized using the data pointer. This allows an individual data byte or a series of data bytes to be written into, or read from, the display RAM, controlled by commands sent on the I²C-bus.

7.12 Subaddress counter

The storage and retrieval of display data is dependent on the content of the subaddress counter. Storage takes place only when the contents of the subaddress counter agree with the hardware subaddress. The hardware subaddress of the PCF8578, valid in mixed mode only, is fixed at 0000.

7.13 I²C-bus controller

The I²C-bus controller detects the I²C-bus protocol, slave address, commands and display data bytes. It performs the conversion of the data input (serial-to-parallel) and the data output (parallel-to-serial). The PCF8578 acts as an I²C-bus slave transmitter/receiver in mixed mode, and as a slave receiver in row mode. A slave device cannot control bus communication.

7.14 Input filters

To enhance noise immunity in electrically adverse environments, RC low-pass filters are provided on the SDA and SCL lines.

7.15 RAM access

RAM operations are only possible when the PCF8578 is in mixed mode.

In this event its hardware subaddress is internally fixed at 0000 and the hardware subaddresses of any PCF8579 used in conjunction with the PCF8578 must start at 0001.

There are three RAM ACCESS modes:

- Character
- Half-graphic
- Full-graphic.

These modes are specified by bits G1 to G0 of the RAM ACCESS command. The RAM ACCESS command controls the order in which data is written to or read from the RAM (see Fig.10).

To store RAM data, the user specifies the location into which the first byte will be loaded (see Fig.11):

- Device subaddress (specified by the DEVICE SELECT command)
- RAM X-address (specified by the LOAD X-ADDRESS command)
- RAM bank (specified by bits Y1 and Y0 of the RAM ACCESS command).

Subsequent data bytes will be written or read according to the chosen RAM ACCESS mode. Device subaddresses are automatically incremented between devices until the last device is reached. If the last device has subaddress 15, further display data transfers will lead to a wrap-around of the subaddress to 0.

7.16 Display control

The display is generated by continuously shifting rows of RAM data to the dot matrix LCD via the column outputs. The number of rows scanned depends on the multiplex rate set by bits M1 and M0 of the SET MODE command.

The display status (all dots on/off and normal/inverse video) is set by bits E1 and E0 of the SET MODE command. For bank switching, the RAM bank corresponding to the top of the display is set by bits B1 and B0 of the SET START BANK command. This is shown in Fig.12. This feature is useful when scrolling in alphanumeric applications.

7.17 TEST pin

The TEST pin must be connected to V_{SS}.

LCD row/column driver for dot matrix graphic displays

PCF8578

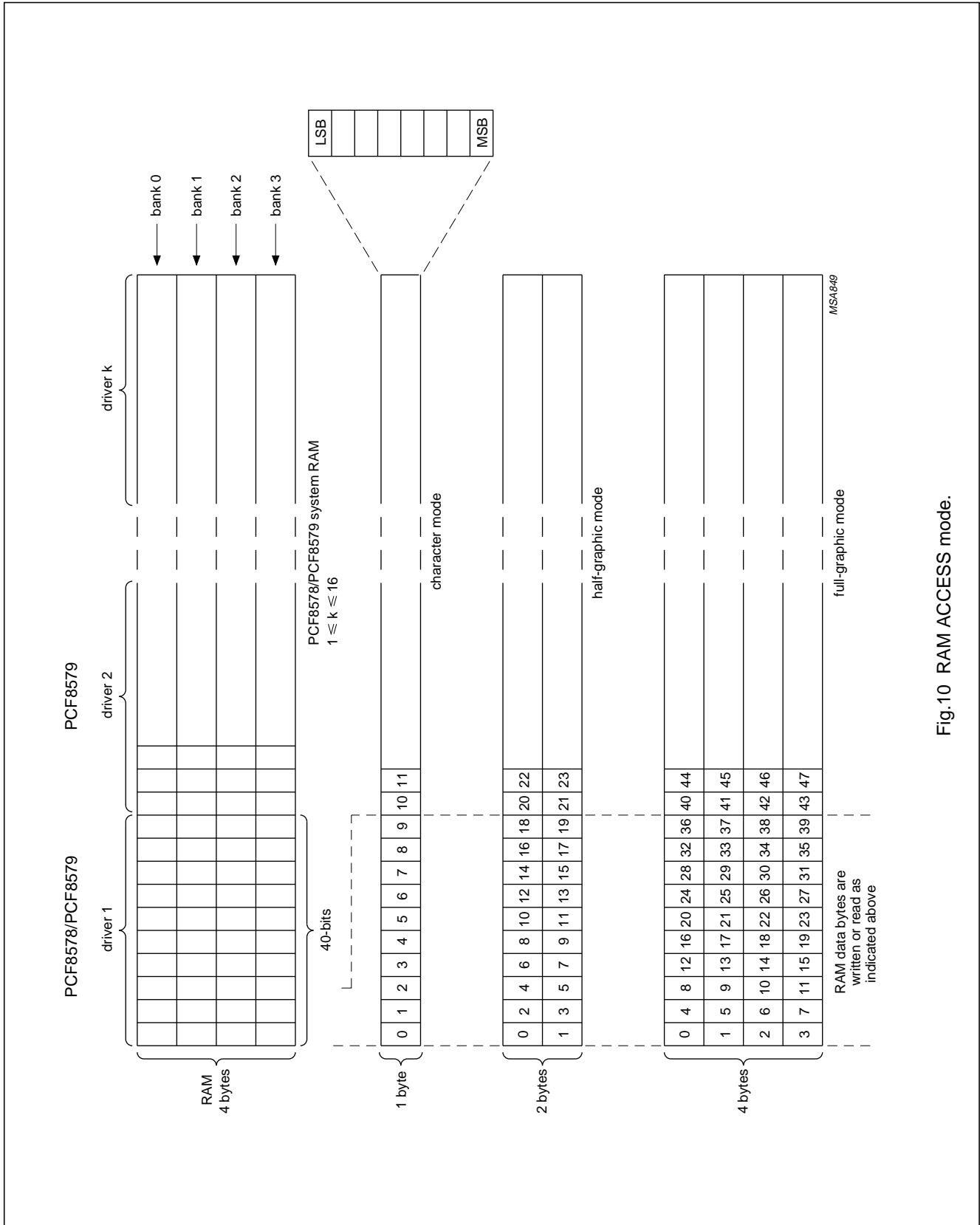

Fig.10 RAM ACCESS mode.

LCD row/column driver for dot matrix graphic displays

PCF8578

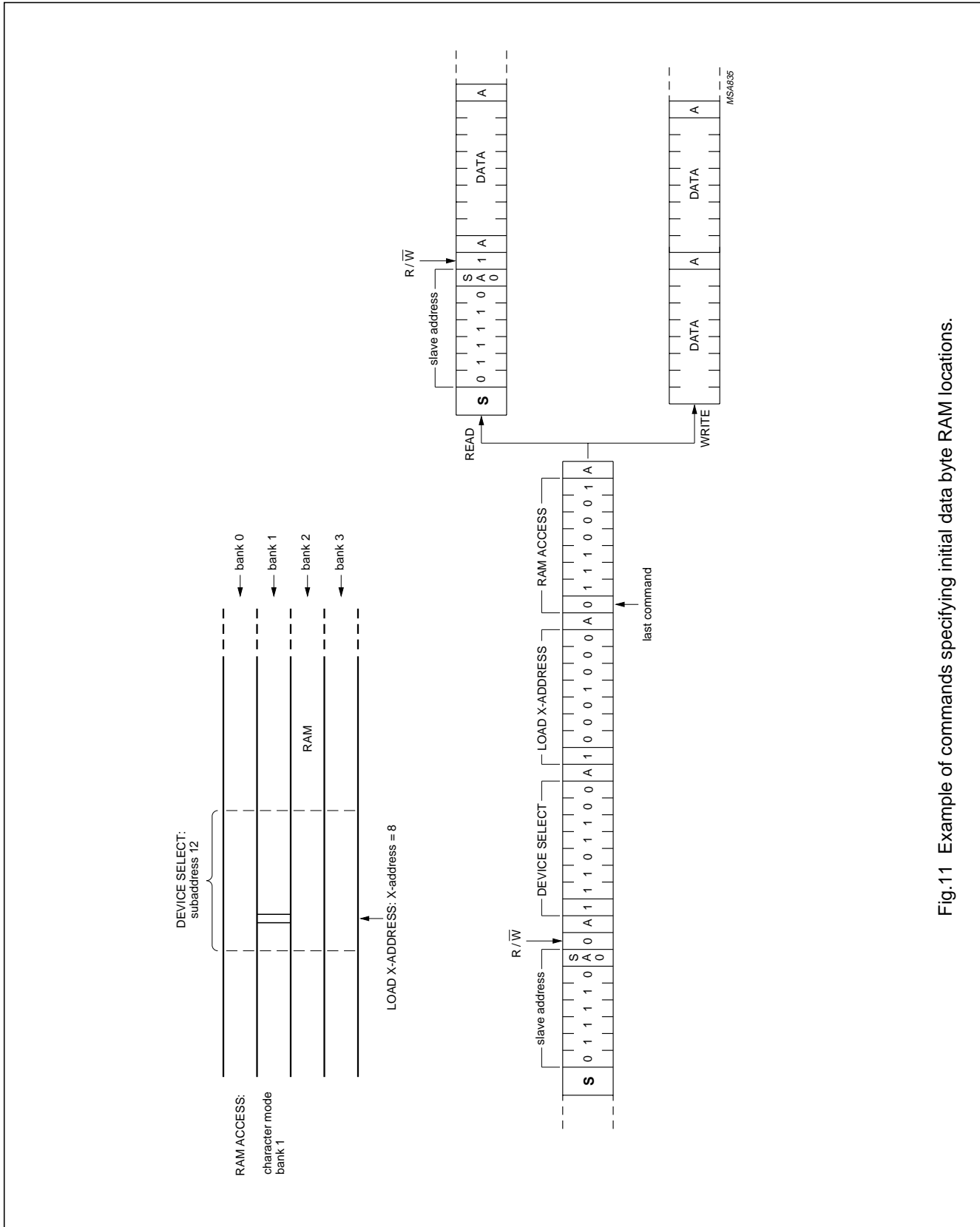

Fig.11 Example of commands specifying initial data byte RAM locations.

LCD row/column driver for dot matrix graphic displays

PCF8578

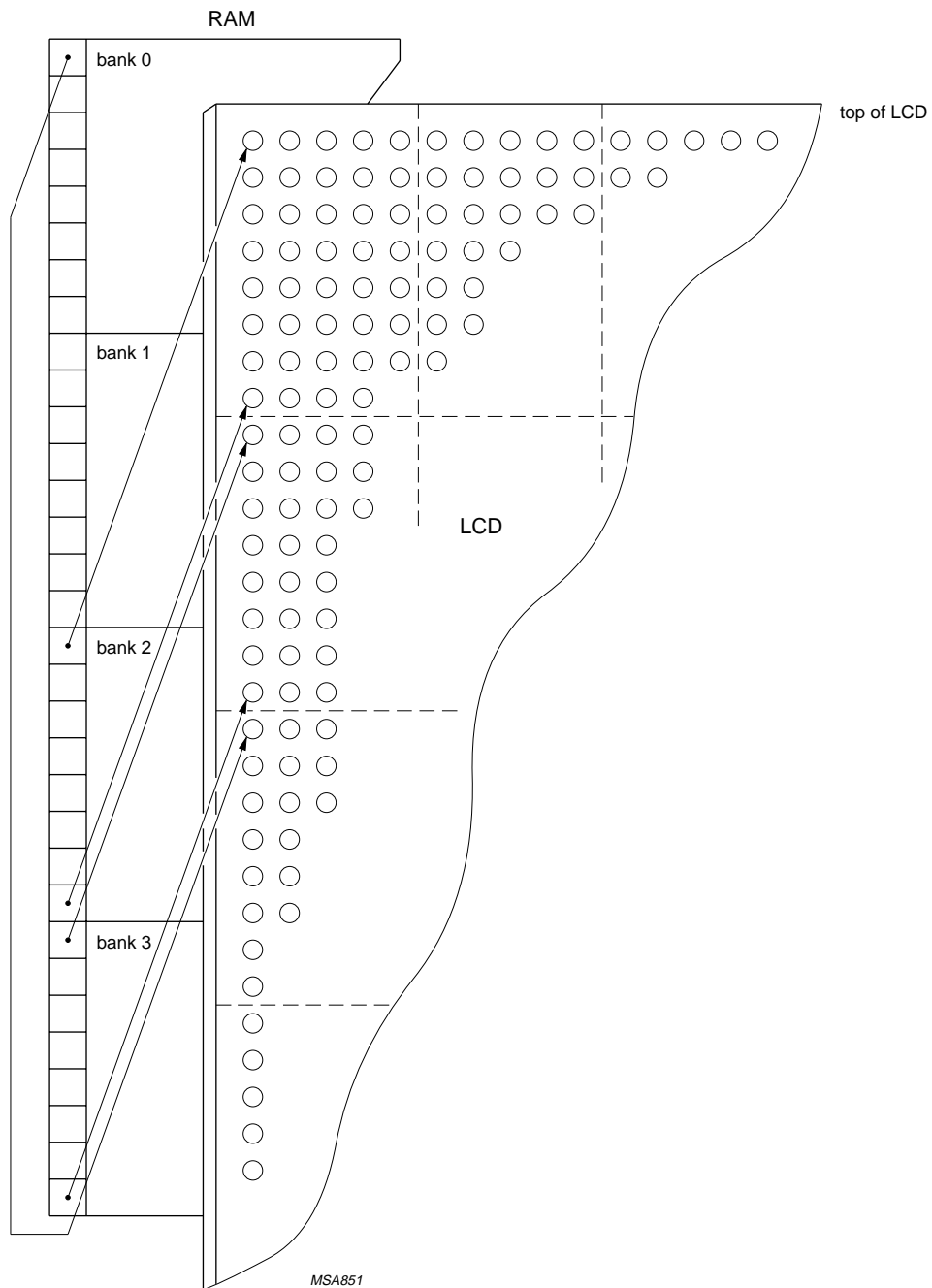

Fig.12 Relationship between display and SET START BANK; 1 : 32 multiplex rate and start bank = 2.

LCD row/column driver for dot matrix graphic displays

PCF8578

8 I²C-BUS PROTOCOL

Two 7-bit slave addresses (0111100 and 0111101) are reserved for both the PCF8578 and PCF8579. The least significant bit of the slave address is set by connecting input SA0 to either 0 (V_{SS}) or 1 (V_{DD}). Therefore, two types of PCF8578 or PCF8579 can be distinguished on the same I²C-bus which allows:

1. One PCF8578 to operate with up to 32 PCF8579s on the same I²C-bus for very large applications
2. The use of two types of LCD multiplex schemes on the same I²C-bus.

In most applications the PCF8578 will have the same slave address as the PCF8579.

The I²C-bus protocol is shown in Fig.13.

All communications are initiated with a start condition (S) from the I²C-bus master, which is followed by the desired slave address and read/write bit. All devices with this slave address acknowledge in parallel. All other devices ignore the bus transfer.

In WRITE mode (indicated by setting the read/write bit LOW) one or more commands follow the slave address acknowledgement. The commands are also acknowledged by all addressed devices on the bus. The last command must clear the continuation bit C. After the last command a series of data bytes may follow. The acknowledgement after each byte is made only by the (A0, A1, A2 and A3) addressed PCF8579 or PCF8578 with its implicit subaddress 0. After the last data byte has been acknowledged, the I²C-bus master issues a stop condition (P).

In READ mode, indicated by setting the read/write bit HIGH, data bytes may be read from the RAM following the slave address acknowledgement. After this acknowledgement the master transmitter becomes a master receiver and the PCF8578 becomes a slave transmitter. The master receiver must acknowledge the reception of each byte in turn. The master receiver must signal an end of data to the slave transmitter, by not generating an acknowledge on the last byte clocked out of the slave. The slave transmitter then leaves the data line HIGH, enabling the master to generate a stop condition (P).

Display bytes are written into, or read from, the RAM at the address specified by the data pointer and subaddress counter. Both the data pointer and subaddress counter are automatically incremented, enabling a stream of data to be transferred either to, or from, the intended devices.

In multiple device applications, the hardware subaddress pins of the PCF8579s (A0 to A3) are connected to V_{SS} or V_{DD} to represent the desired hardware subaddress code. If two or more devices share the same slave address, then each device **must** be allocated a unique hardware subaddress.

LCD row/column driver for dot matrix graphic displays

PCF8578

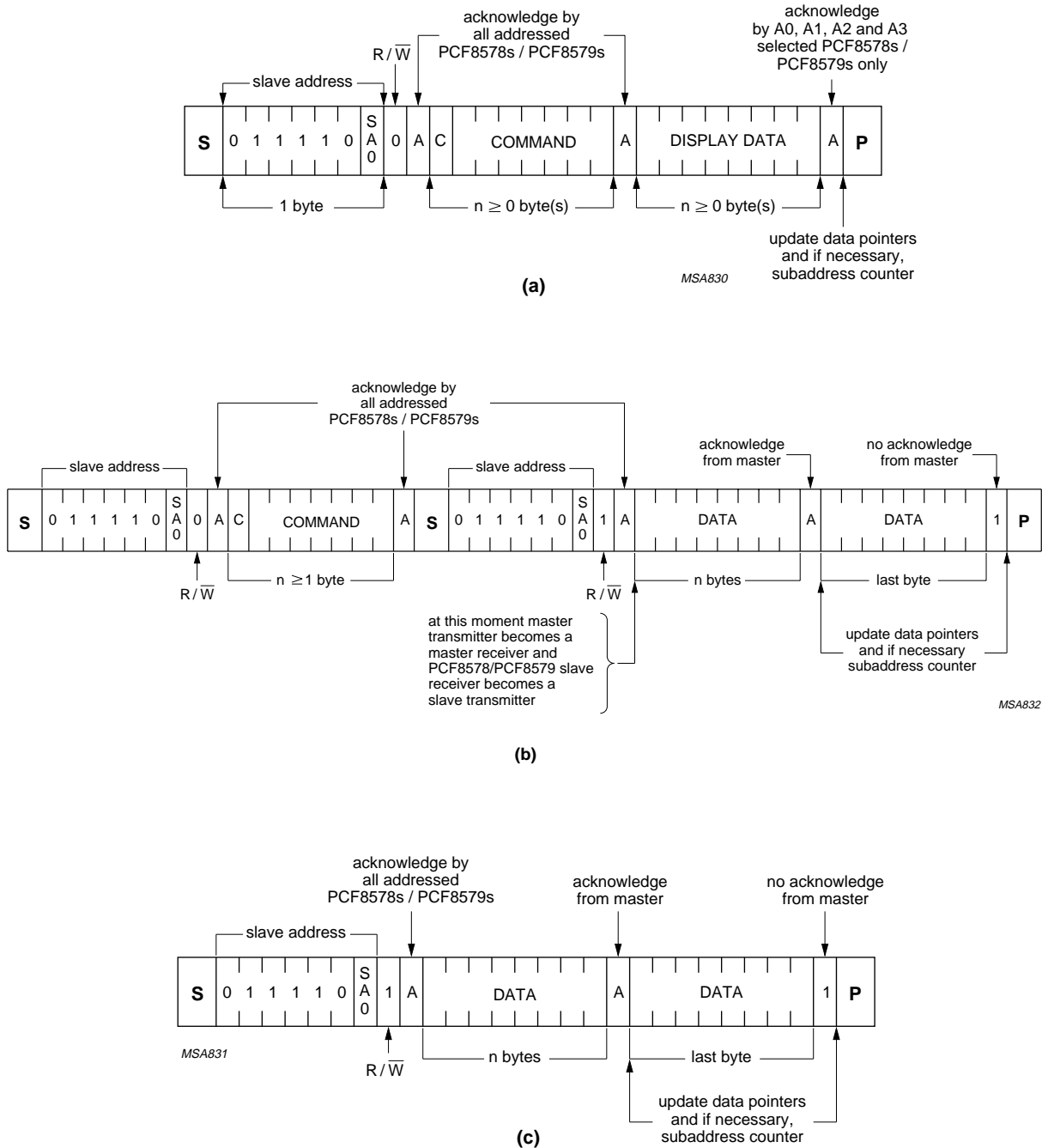

Fig.13 (a) Master transmits to slave receiver (WRITE mode); (b) Master reads after sending command string (WRITE commands; READ data); (c) Master reads slave immediately after sending slave address (READ mode).

LCD row/column driver for dot matrix graphic displays

PCF8578

8.1 Command decoder

The command decoder identifies command bytes that arrive on the I²C-bus. The most-significant bit of a command is the continuation bit C (see Fig.14). When this bit is set, it indicates that the next byte to be transferred will also be a command. If the bit is reset, it indicates the conclusion of the command transfer. Further bytes will be regarded as display data. Commands are transferred in WRITE mode only.

The five commands available to the PCF8578 are defined in Tables 5 and 6.

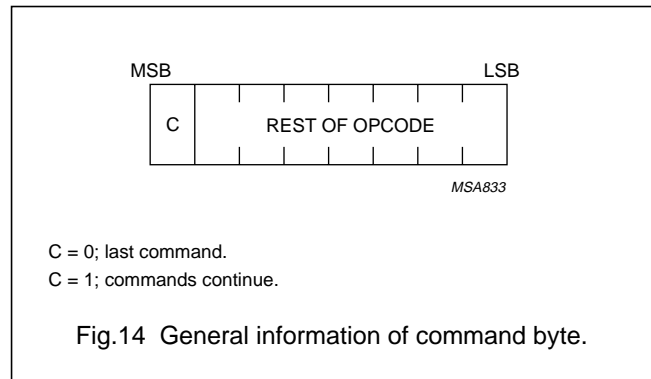

Table 5 Summary of commands

COMMAND	OPCODE ⁽¹⁾								DESCRIPTION
SET MODE	C	1	0	D	D	D	D	D	multiplex rate, display status, system type
SET START BANK	C	1	1	1	1	1	D	D	defines bank at top of LCD
DEVICE SELECT	C	1	1	0	D	D	D	D	defines device subaddress
RAM ACCESS	C	1	1	1	D	D	D	D	graphic mode, bank select (D D D D ≥ 12 is not allowed; see SET START BANK opcode)
LOAD X-ADDRESS	C	0	D	D	D	D	D	D	0 to 39

Note

1. C = command continuation bit. D = may be a logic 1 or 0.

LCD row/column driver for dot matrix graphic displays

PCF8578

Table 6 Definition of PCF8578/PCF8579 commands

COMMAND	OPCODE	OPTIONS	DESCRIPTION
SET MODE	C 1 0 T E1 E0 M1 M0	see Table 7	defines LCD drive mode
		see Table 8	defines display status
		see Table 9	defines system type
SET START BANK	C 1 1 1 1 1 B1 B0	see Table 10	defines pointer to RAM bank corresponding to the top of the LCD; useful for scrolling, pseudo-motion and background preparation of new display
DEVICE SELECT	C 1 1 0 A3 A2 A1 A0	see Table 11	four bits of immediate data, bits A0 to A3, are transferred to the subaddress counter to define one of sixteen hardware subaddresses
RAM ACCESS	C 1 1 1 G1 G0 Y1 Y0	see Table 12	defines the auto-increment behaviour of the address for RAM access
		see Table 13	two bits of immediate data, bits Y0 to Y1, are transferred to the X-address pointer to define one of forty display RAM columns
LOAD X-ADDRESS	C 0 X5 X4 X3 X2 X1 X0	see Table 14	six bits of immediate data, bits X0 to X5, are transferred to the X-address pointer to define one of forty display RAM columns

LCD row/column driver for dot matrix graphic displays

PCF8578

Table 7 Set mode option 1

LCD DRIVE MODE		BITS	
		M1	M0
1 : 8	MUX (8 rows)	0	1
1 : 16	MUX (16 rows)	1	0
1 : 24	MUX (24 rows)	1	1
1 : 32	MUX (32 rows)	0	0

Table 8 Set mode option 2

DISPLAY STATUS	BITS	
	E1	E0
Blank	0	0
Normal	0	1
All segments on	1	0
Inverse video	1	1

Table 9 Set mode option 3

SYSTEM TYPE	BIT T
PCF8578 row only	0
PCF8578 mixed mode	1

Table 10 Set start bank option 1

START BANK POINTER	BITS	
	B1	B0
Bank 0	0	0
Bank 1	0	1
Bank 2	1	0
Bank 3	1	1

Table 11 Device select option 1

DESCRIPTION	BITS			
Decimal value 0 to 15	A3	A2	A1	A0

Table 12 RAM access option 1

RAM ACCESS MODE	BITS	
	G1	G0
Character	0	0
Half-graphic	0	1
Full-graphic	1	0
Not allowed (note 1)	1	1

Note

1. See opcode for SET START BANK in Table 6.

Table 13 Device select option 1

DESCRIPTION	BITS	
Decimal value 0 to 3	Y1	Y0

Table 14 Device select option 1

DESCRIPTION	BITS					
Decimal value 0 to 39	X5	X4	X3	X2	X1	X0

LCD row/column driver for dot matrix graphic displays

PCF8578

9 CHARACTERISTICS OF THE I²C-BUS

The I²C-bus is for bidirectional, two-line communication between different ICs or modules. The two lines are a serial data line (SDA) and a serial clock line (SCL) which must be connected to a positive supply via a pull-up resistor. Data transfer may be initiated only when the bus is not busy.

9.1 Bit transfer

One data bit is transferred during each clock pulse. The data on the SDA line must remain stable during the HIGH period of the clock pulse as changes in the data line at this moment will be interpreted as control signals.

9.2 Start and stop conditions

Both data and clock lines remain HIGH when the bus is not busy. A HIGH-to-LOW transition of the data line, while the clock is HIGH, is defined as the START condition (S). A LOW-to-HIGH transition of the data line while the clock is HIGH, is defined as the STOP condition (P).

9.3 System configuration

A device transmitting a message is a 'transmitter', a device receiving a message is the 'receiver'. The device that controls the message flow is the 'master' and the devices which are controlled by the master are the 'slaves'.

9.4 Acknowledge

The number of data bytes transferred between the start and stop conditions from transmitter to receiver is unlimited. Each data byte of eight bits is followed by one acknowledge bit. The acknowledge bit is a HIGH level put on the bus by the transmitter, whereas the master generates an extra acknowledge related clock pulse. A slave receiver which is addressed must generate an acknowledge after the reception of each byte. Also a master must generate an acknowledge after the reception of each byte that has been clocked out of the slave transmitter. The device that acknowledges must pull down the SDA line during the acknowledge clock pulse, so that the SDA line is stable LOW during the HIGH period of the acknowledge related clock pulse (set-up and hold times must be taken into consideration). A master receiver must signal the end of a data transmission to the transmitter by **not** generating an acknowledge on the last byte that has been clocked out of the slave. In this event the transmitter must leave the data line HIGH to enable the master to generate a stop condition.

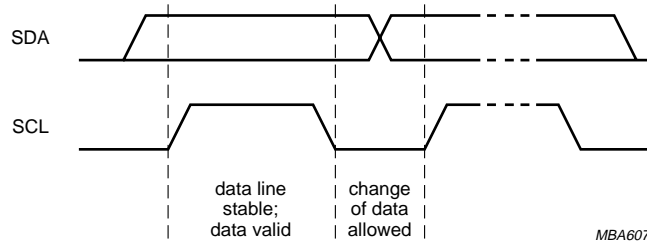

Fig.15 Bit transfer.

LCD row/column driver for dot matrix graphic displays

PCF8578

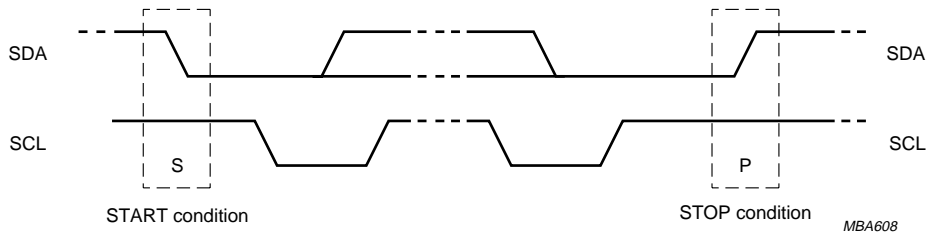

Fig.16 Definition of start and stop condition.

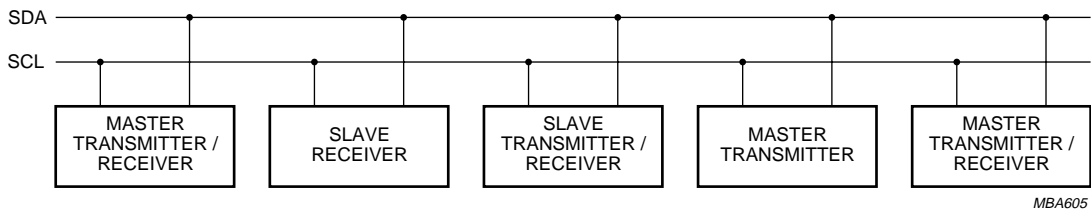
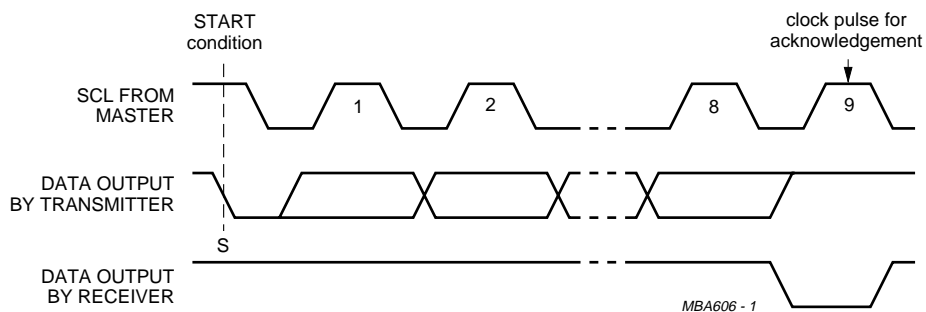

Fig.17 System configuration.



The general characteristics and detailed specification of the I²C-bus are available on request.

Fig.18 Acknowledgement on the I²C-bus.

LCD row/column driver for dot matrix graphic displays

PCF8578

10 LIMITING VALUES

In accordance with the Absolute Maximum Rating System (IEC 134).

SYMBOL	PARAMETER	MIN.	MAX.	UNIT
V_{DD}	supply voltage	-0.5	+8.0	V
V_{LCD}	LCD supply voltage	$V_{DD} - 11$	V_{DD}	V
V_{I1}	input voltage SDA, SCL, CLK, TEST, SA0 and OSC	$V_{SS} - 0.5$	$V_{DD} + 0.5$	V
V_{I2}	input voltage V_2 to V_5	$V_{LCD} - 0.5$	$V_{DD} + 0.5$	V
V_{O1}	output voltage \overline{SYNC} and CLK	$V_{SS} - 0.5$	$V_{DD} + 0.5$	V
V_{O2}	output voltage R0 to R7, R8/C8 to R31/C31 and C32 to C39	$V_{LCD} - 0.5$	$V_{DD} + 0.5$	V
I_I	DC input current	-10	+10	mA
I_O	DC output current	-10	+10	mA
I_{DD}, I_{SS}, I_{LCD}	V_{DD}, V_{SS} or V_{LCD} current	-50	+50	mA
P_{tot}	total power dissipation per package	-	400	mW
P_o	power dissipation per output	-	100	mW
T_{stg}	storage temperature	-65	+150	°C

11 HANDLING

Inputs and outputs are protected against electrostatic discharge in normal handling. However, to be totally safe it is desirable to take normal precautions appropriate to handling MOS devices. Advice can be found in Data Handbook IC12 under "Handling MOS Devices".

LCD row/column driver for dot matrix graphic displays

PCF8578

12 DC CHARACTERISTICS

$V_{DD} = 2.5$ to 6 V; $V_{SS} = 0$ V; $V_{LCD} = V_{DD} - 3.5$ V to $V_{DD} - 9$ V; $T_{amb} = -40$ to $+85$ °C; unless otherwise specified.

SYMBOL	PARAMETER	CONDITIONS	MIN.	TYP.	MAX.	UNIT
Supplies						
V_{DD}	supply voltage		2.5	–	6.0	V
V_{LCD}	LCD supply voltage		$V_{DD} - 9$	–	$V_{DD} - 3.5$	V
I_{DD1}	supply current external clock	$f_{CLK} = 2$ kHz; note 1	–	6	15	μ A
I_{DD2}	supply current internal clock	$R_{OSC} = 330$ k Ω	–	20	50	μ A
V_{POR}	power-on reset level	note 2	0.8	1.3	1.8	V
Logic						
V_{IL}	LOW level input voltage		V_{SS}	–	$0.3V_{DD}$	V
V_{IH}	HIGH level input voltage		$0.7V_{DD}$	–	V_{DD}	V
I_{OL1}	LOW level output current at \overline{SYNC} and CLK	$V_{OL} = 1$ V; $V_{DD} = 5$ V	1	–	–	mA
I_{OH1}	HIGH level output current at \overline{SYNC} and CLK	$V_{OH} = 4$ V; $V_{DD} = 5$ V	–	–	–1	mA
I_{OL2}	LOW level output current at SDA	$V_{OL} = 0.4$ V; $V_{DD} = 5$ V	3	–	–	mA
I_{L1}	leakage current at SDA, SCL, \overline{SYNC} , CLK, TEST and SA0	$V_i = V_{DD}$ or V_{SS}	–	–	+1	mA
I_{L2}	leakage current at OSC	$V_i = V_{DD}$	–	–	+1	μ A
C_i	input capacitance at SCL and SDA	note 3	–	–	5	pF
LCD outputs						
I_{L3}	leakage current at V_2 to V_5	$V_i = V_{DD}$ or V_{LCD}	–2	–	+2	μ A
V_{DC}	DC component of LCD drivers R0 to R7, R8/C8 to R31/C31 and C32 to C39		–	± 20	–	mV
R_{ROW}	output resistance R0 to R7 and R8/C8 to R31/C31	row mode; note 4	–	1.5	3	k Ω
R_{COL}	output resistance R8/C8 to R31/C31 and C32 to C39	column mode; note 4	–	3	6	k Ω

Notes

- Outputs are open; inputs at V_{DD} or V_{SS} ; I²C-bus inactive; external clock with 50% duty factor.
- Resets all logic when $V_{DD} < V_{POR}$.
- Periodically sampled; not 100% tested.
- Resistance measured between output terminal (R0 to R7, R8/C8 to R31/C31 and C32 to C39) and bias input (V_2 to V_5 , V_{DD} and V_{LCD}) when the specified current flows through one output under the following conditions (see Table 2):
 - $V_{op} = V_{DD} - V_{LCD} = 9$ V.
 - Row mode, R0 to R7 and R8/C8 to R31/C31: $V_2 - V_{LCD} \geq 6.65$ V; $V_5 - V_{LCD} \leq 2.35$ V; $I_{LOAD} = 150$ μ A.
 - Column mode, R8/C8 to R31/C31 and C32 to C39: $V_3 - V_{LCD} \geq 4.70$ V; $V_4 - V_{LCD} \leq 4.30$ V; $I_{LOAD} = 100$ μ A.

LCD row/column driver for dot matrix graphic displays

PCF8578

13 AC CHARACTERISTICS

All timing values are referenced to V_{IH} and V_{IL} levels with an input voltage swing of V_{SS} to V_{DD} .

$V_{DD} = 2.5$ to 6 V; $V_{SS} = 0$ V; $V_{LCD} = V_{DD} - 3.5$ V to $V_{DD} - 9$ V; $T_{amb} = -40$ to $+85$ °C; unless otherwise specified.

SYMBOL	PARAMETER	CONDITIONS	MIN.	TYP.	MAX.	UNIT
f_{CLK1}	clock frequency at multiplex rates of 1 : 8, 1 : 16 and 1 : 32	$R_{OSC} = 330$ k Ω ; $V_{DD} = 6$ V	1.2	2.1	3.3	kHz
f_{CLK2}	clock frequency at multiplex rates of 1 : 24	$R_{OSC} = 330$ k Ω ; $V_{DD} = 6$ V	0.9	1.6	2.5	kHz
t_{PSYNC}	SYNC propagation delay		–	–	500	ns
t_{PLCD}	driver delays	$V_{DD} - V_{LCD} = 9$ V; with test loads	–	–	100	μ s
I²C-bus						
f_{SCL}	SCL clock frequency		–	–	100	kHz
t_{SW}	tolerable spike width on bus		–	–	100	ns
t_{BUF}	bus free time		4.7	–	–	μ s
$t_{SU;STA}$	start condition set-up time	repeated start codes only	4.7	–	–	μ s
$t_{HD;STA}$	start condition hold time		4.0	4.0	–	μ s
t_{LOW}	SCL LOW time		4.7	–	–	μ s
t_{HIGH}	SCL HIGH time		4.0	–	–	μ s
t_r	SCL and SDA rise time		–	–	1	μ s
t_f	SCL and SDA fall time		–	–	0.3	μ s
$t_{SU;DAT}$	data set-up time		250	–	–	ns
$t_{HD;DAT}$	data hold time		0	–	–	ns
$t_{SU;STO}$	stop condition set-up time		4.0	–	–	μ s

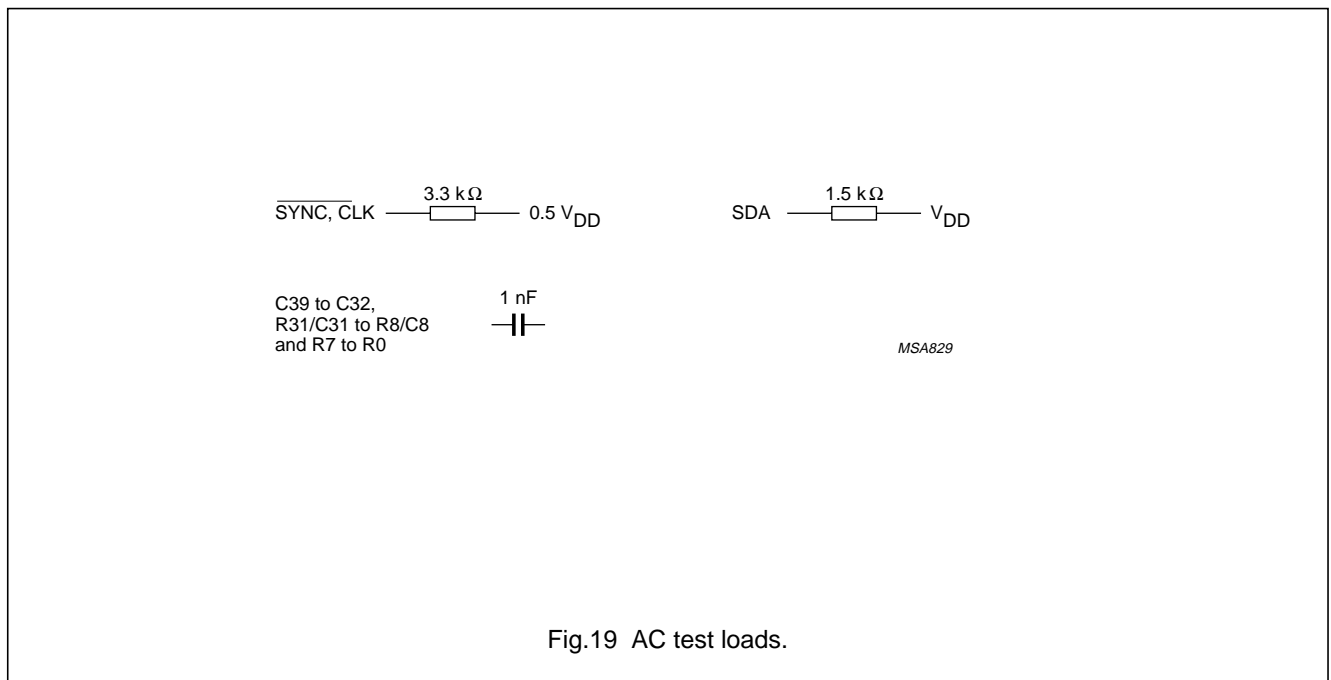

Fig.19 AC test loads.

LCD row/column driver for dot matrix graphic displays

PCF8578

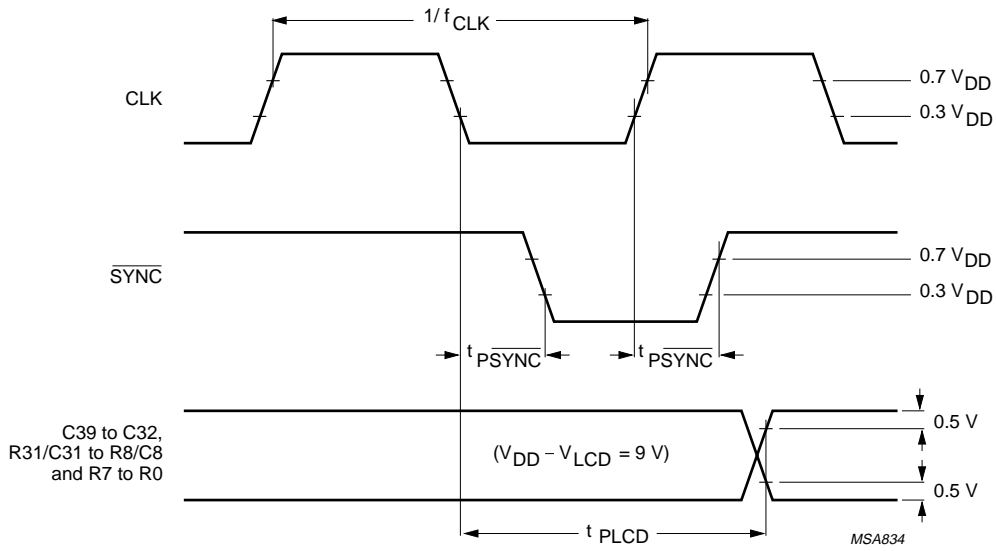

Fig.20 Driver timing waveforms.

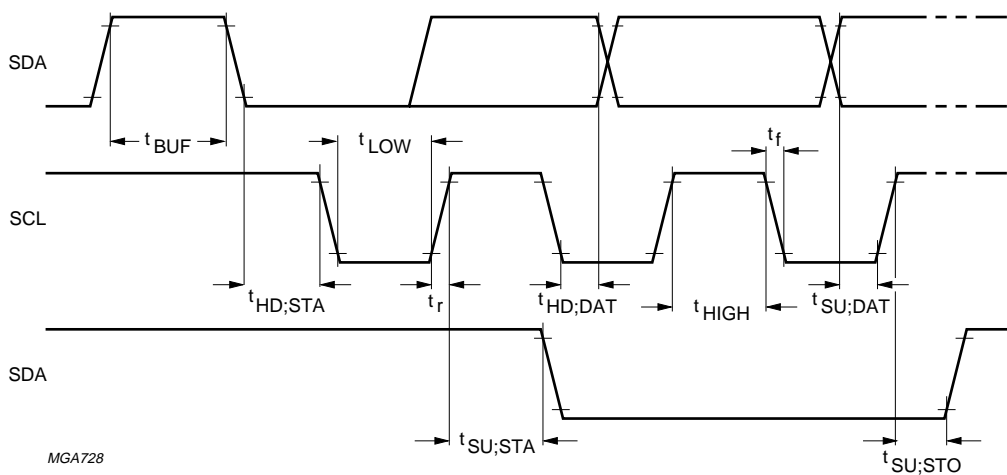
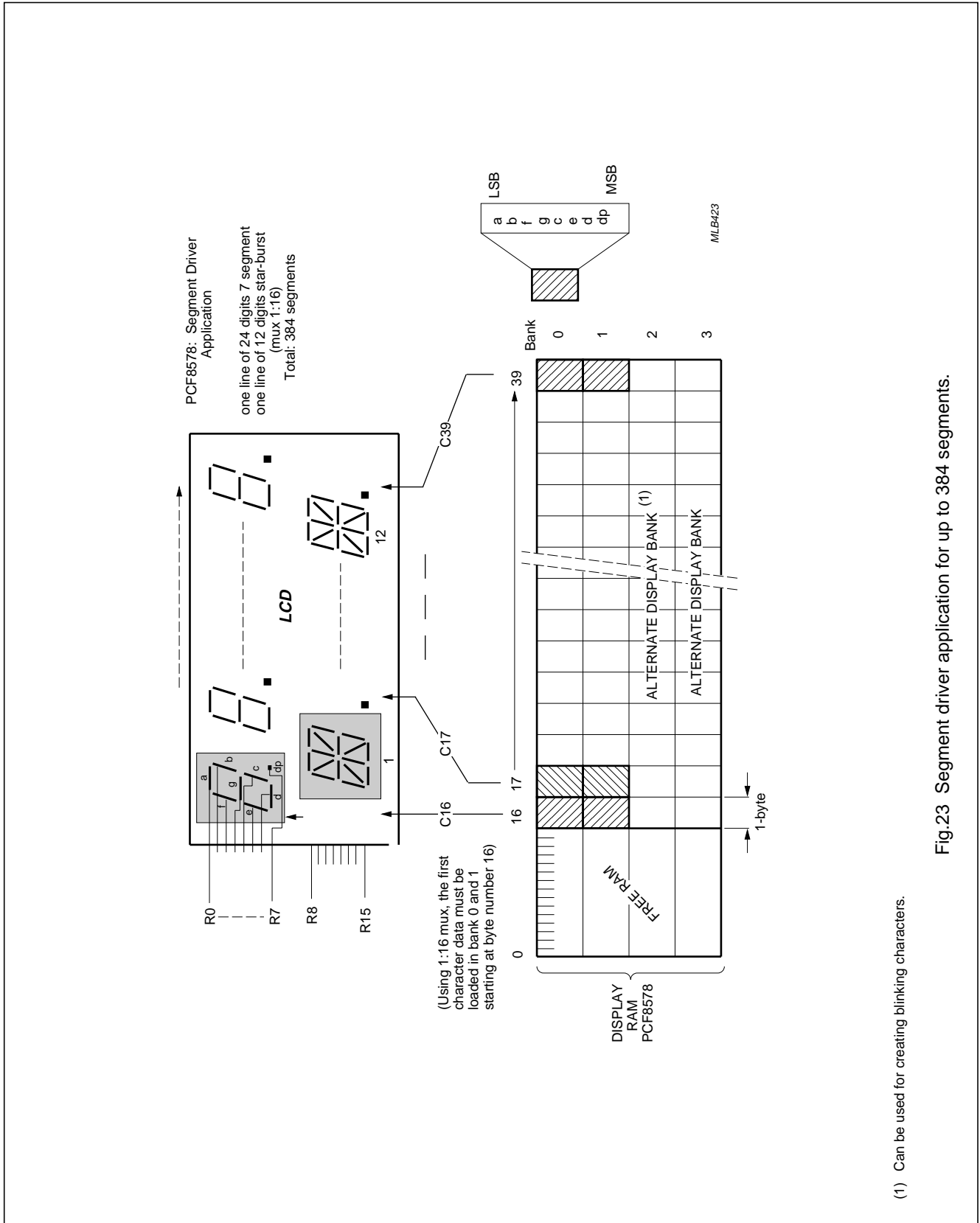

Fig.21 I²C-bus timing waveforms.

LCD row/column driver for dot matrix graphic displays

PCF8578



(1) Can be used for creating blinking characters.

Fig.23 Segment driver application for up to 384 segments.

LCD row/column driver for dot matrix graphic displays

PCF8578

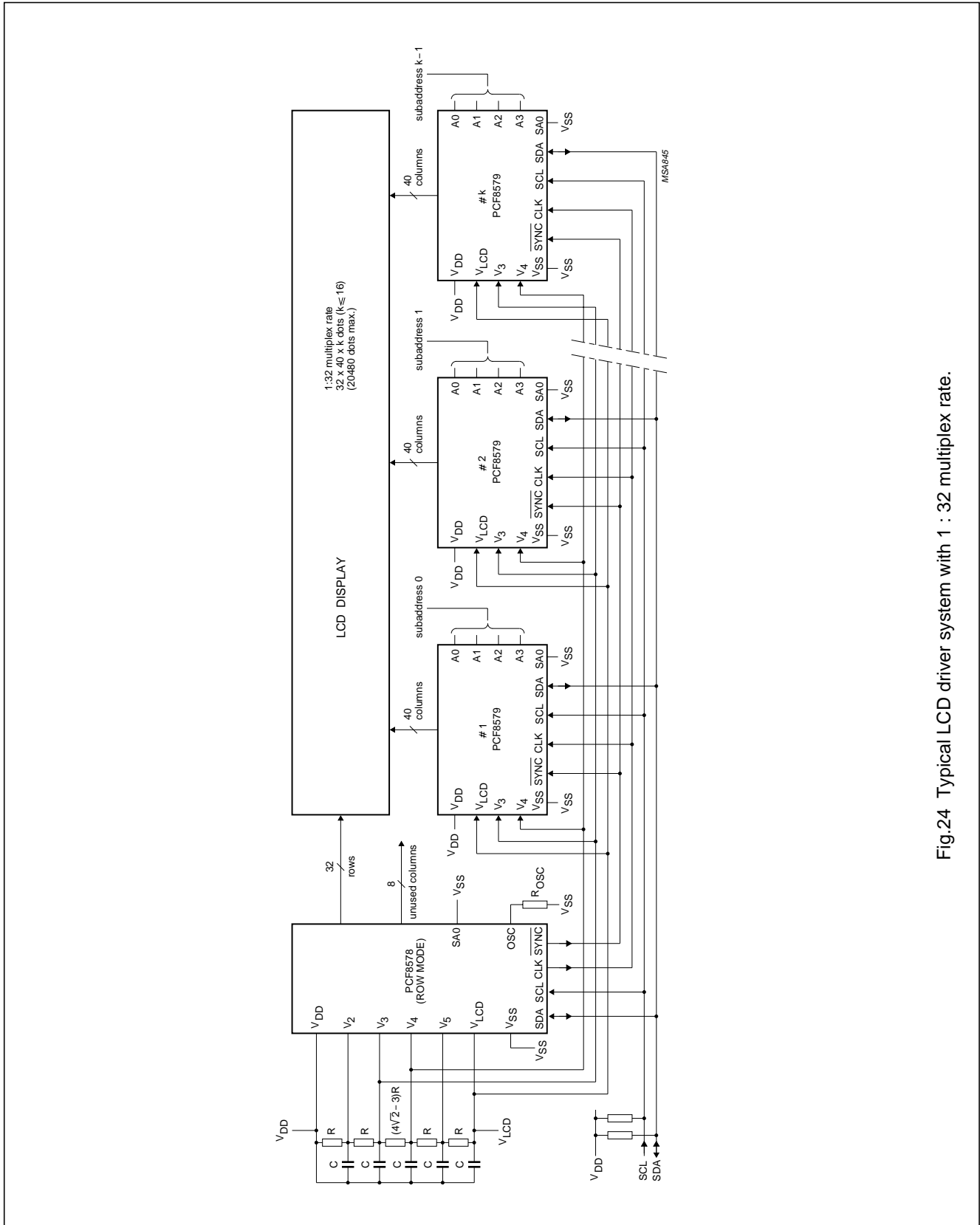

Fig.24 Typical LCD driver system with 1 : 32 multiplex rate.

LCD row/column driver for dot matrix graphic displays

PCF8578

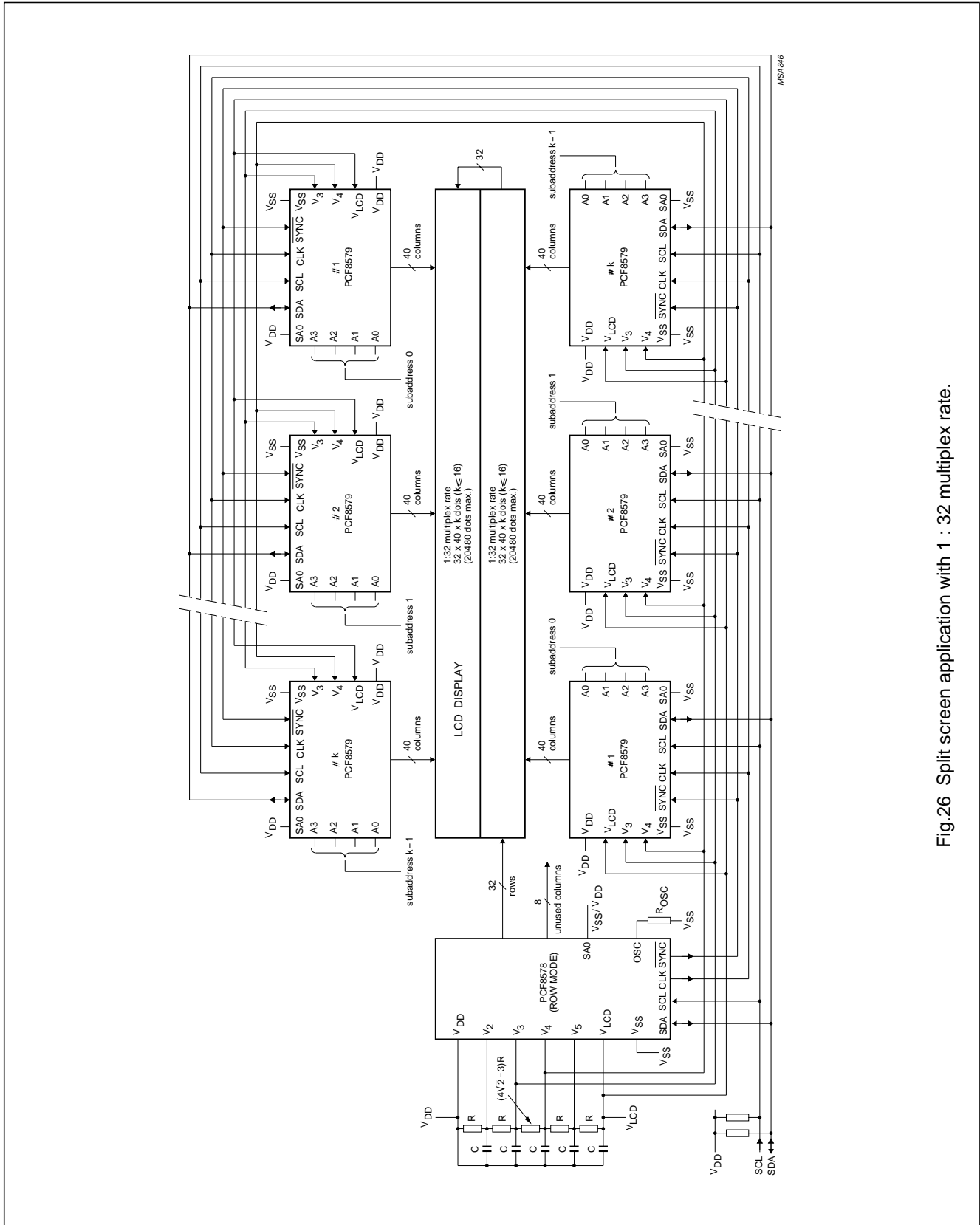

Fig.26 Split screen application with 1 : 32 multiplex rate.

LCD row/column driver for dot matrix graphic displays

PCF8578

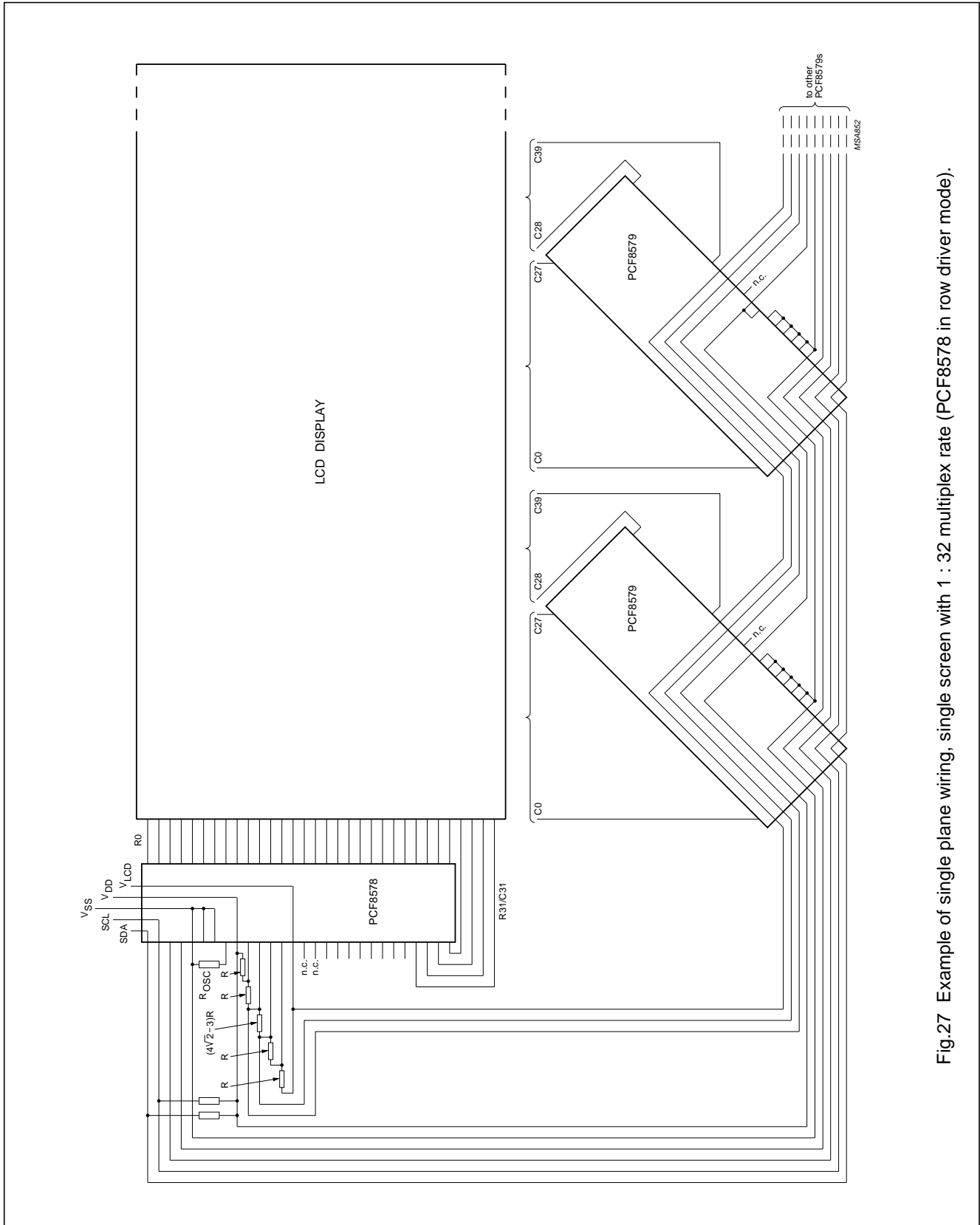

Fig.27 Example of single plane wiring, single screen with 1 : 32 multiplex rate (PCF8578 in row driver mode).

LCD row/column driver for dot matrix graphic displays

PCF8578

15 CHIP DIMENSIONS AND BONDING PAD LOCATIONS

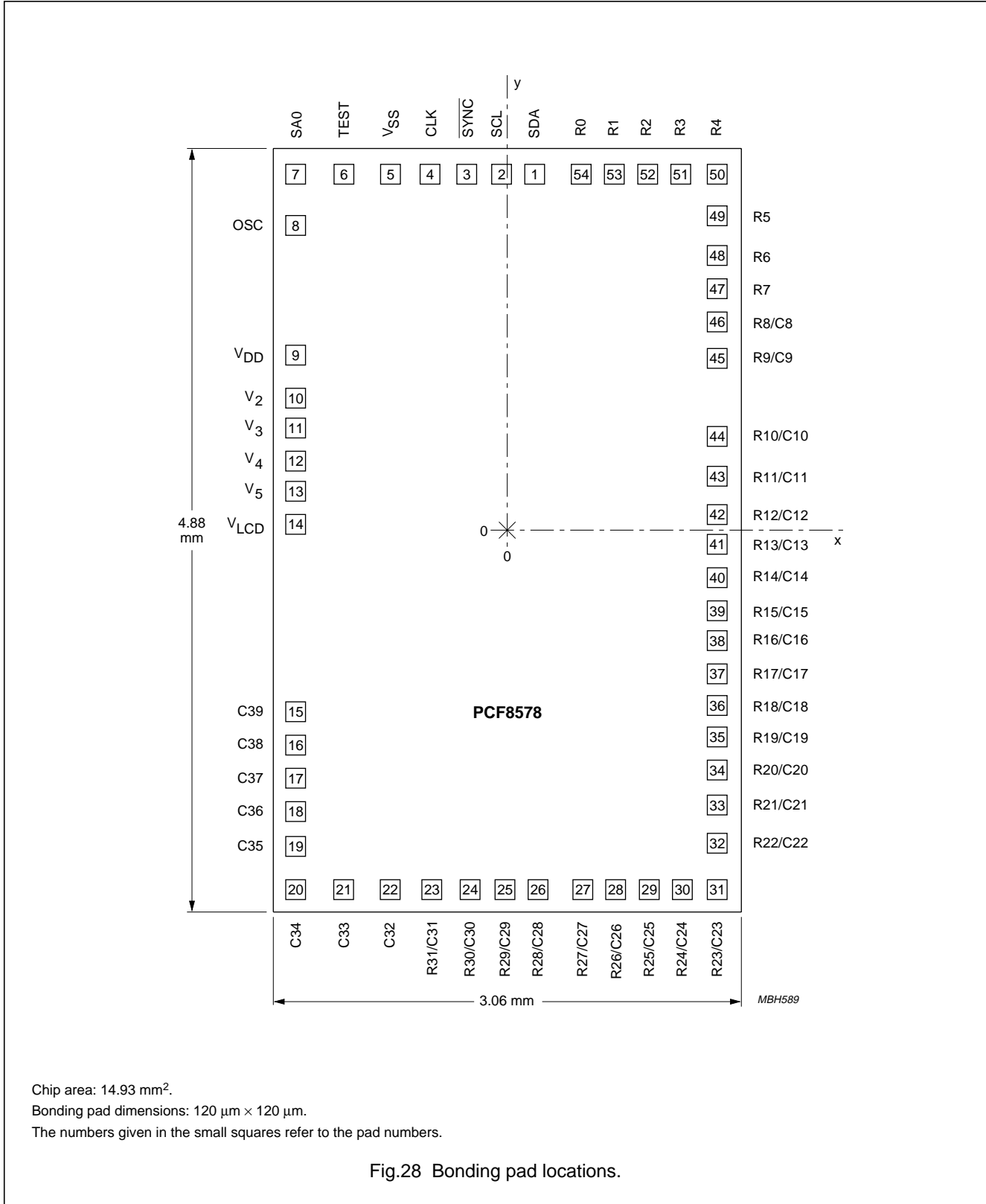

Fig.28 Bonding pad locations.

LCD row/column driver for dot matrix graphic displays

PCF8578

Table 15 Bonding pad locations (dimensions in μm)

All x/y coordinates are referenced to centre of chip, see Fig.28.

PAD NUMBER	SYMBOL	x	y	PINS	
				VSO56	LQFP64
1	SDA	174	2241	1	7
2	SCL	-30	2241	2	8
3	$\overline{\text{SYNC}}$	-234	2241	3	9
4	CLK	-468	2241	4	10
5	V _{SS}	-726	2241	5	11
6	TEST	-1014	2241	6	12
7	SA0	-1308	2241	7	13
8	OSC	-1308	1917	8	16
9	V _{DD}	-1308	1113	9	20
10	V ₂	-1308	873	10	21
11	V ₃	-1308	663	11	22
12	V ₄	-1308	459	12	23
13	V ₅	-1308	255	13	24
14	V _{LCD}	-1308	51	14	25
15	C39	-1308	-1149	17	29
16	C38	-1308	-1353	18	30
17	C37	-1308	-1557	19	31
18	C36	-1308	-1773	20	32
19	C35	-1308	-1995	21	33
20	C34	-1308	-2241	22	34
21	C33	-1014	-2241	23	35
22	C32	-726	-2241	24	37
23	R31/C31	-468	-2241	25	38
24	R30/C30	-234	-2241	26	39
25	R29/C29	-30	-2241	27	40
26	R28/C28	174	-2241	28	41
27	R27/C27	468	-2241	29	42
28	R26/C26	672	-2241	30	43
29	R25/C25	876	-2241	31	44
30	R24/C24	1080	-2241	32	45
31	R23/C23	1308	-2241	33	46
32	R22/C22	1308	-1977	34	48
33	R21/C21	1308	-1731	35	49
34	R20/C20	1308	-1515	36	50
35	R19/C19	1308	-1305	37	51
36	R18/C18	1308	-1101	38	52
37	R17/C17	1308	-897	39	53

LCD row/column driver for dot matrix
graphic displays

PCF8578

PAD NUMBER	SYMBOL	x	y	PINS	
				VSO56	LQFP64
38	R16/C16	1308	-693	40	54
39	R15/C15	1308	-489	41	55
40	R14/C14	1308	-285	42	56
41	R13/C13	1308	-81	43	57
42	R12/C12	1308	123	44	58
43	R11/C11	1308	351	45	59
44	R10/C10	1308	603	46	60
45	R9/C9	1308	1101	47	61
46	R8/C8	1308	1305	48	62
47	R7	1308	1515	49	63
48	R6	1308	1731	50	64
49	R5	1308	1977	51	1
50	R4	1308	2241	52	2
51	R3	1080	2241	53	3
52	R2	876	2241	54	4
53	R1	672	2241	55	5
54	R0	468	2241	56	6
-	n.c.	-	-	15, 16	14, 15, 17 to 19, 26 to 28, 36, 47

LCD row/column driver for dot matrix graphic displays

PCF8578

16 CHIP-ON GLASS INFORMATION

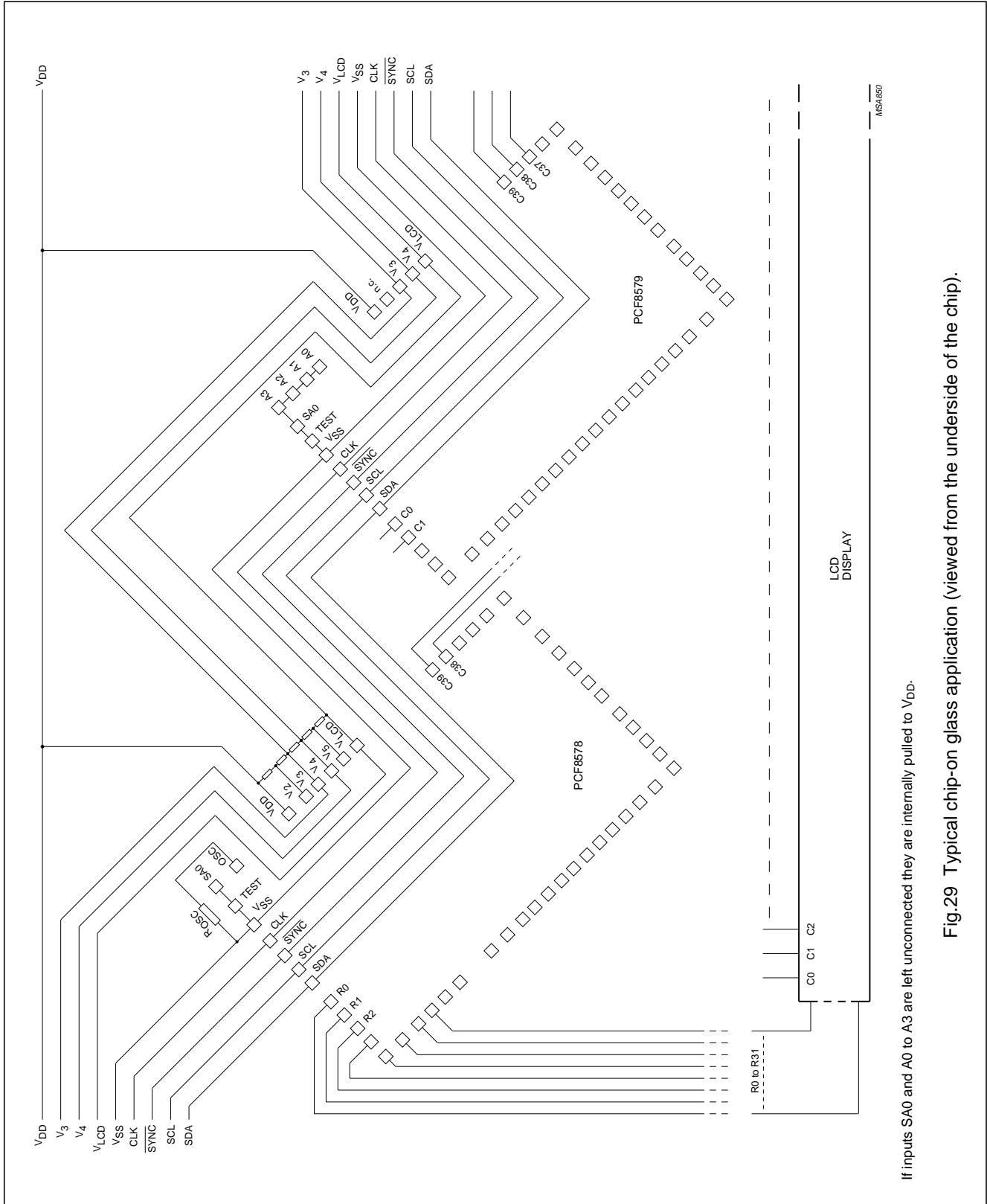

Fig.29 Typical chip-on glass application (viewed from the underside of the chip).

LCD row/column driver for dot matrix graphic displays

PCF8578

17 PACKAGE OUTLINES

VSO56: plastic very small outline package; 56 leads

SOT190-1

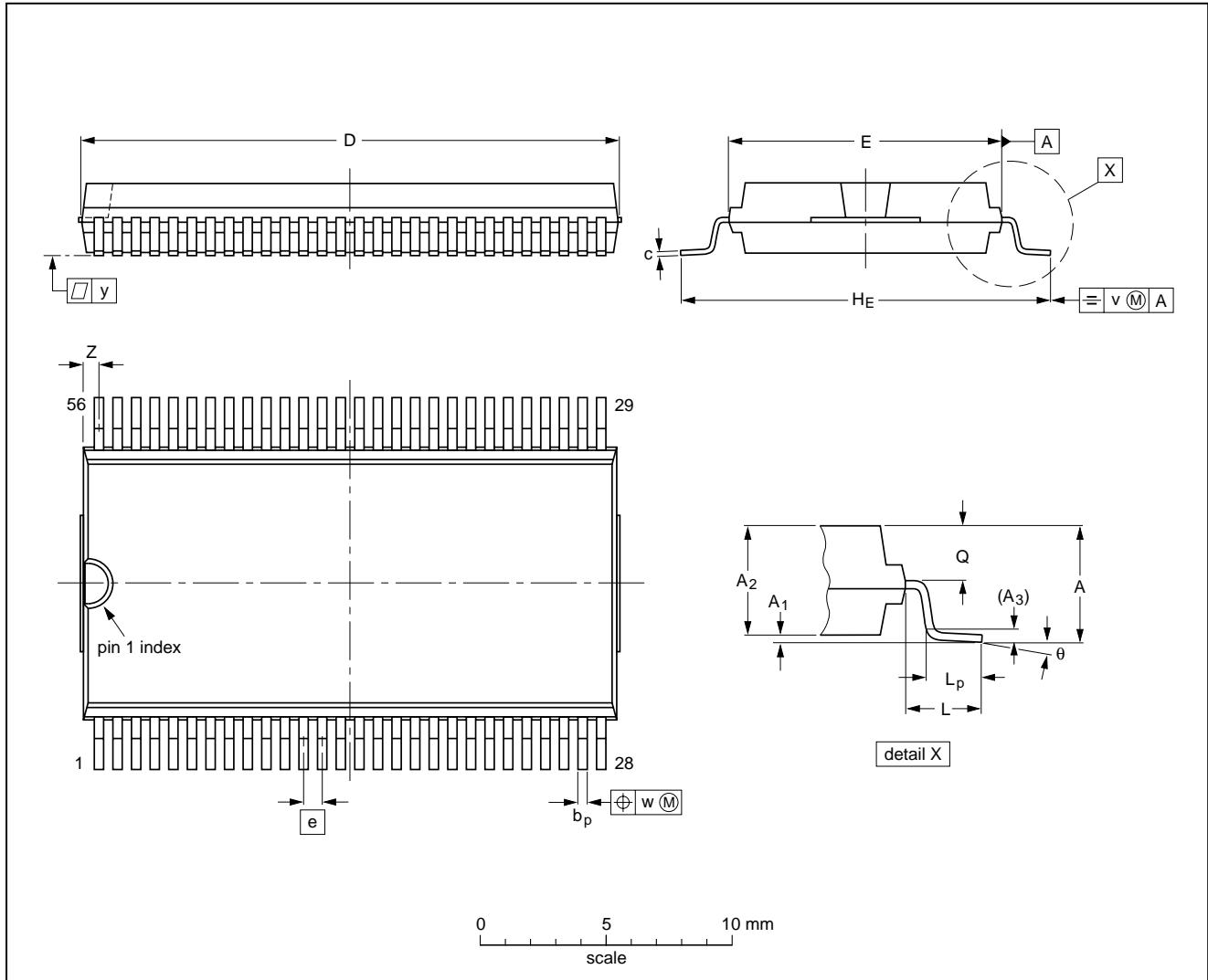

DIMENSIONS (inch dimensions are derived from the original mm dimensions)

UNIT	A max.	A ₁	A ₂	A ₃	b _p	c	D ⁽¹⁾	E ⁽²⁾	e	H _E	L	L _p	Q	v	w	y	Z ⁽¹⁾	θ
mm	3.3	0.3 0.1	3.0 2.8	0.25	0.42 0.30	0.22 0.14	21.65 21.35	11.1 11.0	0.75	15.8 15.2	2.25	1.6 1.4	1.45 1.30	0.2	0.1	0.1	0.90 0.55	7° 0°
inches	0.13	0.012 0.004	0.12 0.11	0.01	0.017 0.012	0.0087 0.0055	0.85 0.84	0.44 0.43	0.03	0.62 0.60	0.089	0.063 0.055	0.057 0.051	0.008	0.004	0.004	0.035 0.022	

Note

1. Plastic or metal protrusions of 0.3 mm maximum per side are not included.
2. Plastic interlead protrusions of 0.25 mm maximum per side are not included.

OUTLINE VERSION	REFERENCES			EUROPEAN PROJECTION	ISSUE DATE
	IEC	JEDEC	EIAJ		
SOT190-1					92-11-17 96-04-02

LCD row/column driver for dot matrix graphic displays

PCF8578

LQFP64: plastic low profile quad flat package; 64 leads; body 10 x 10 x 1.4 mm

SOT314-2

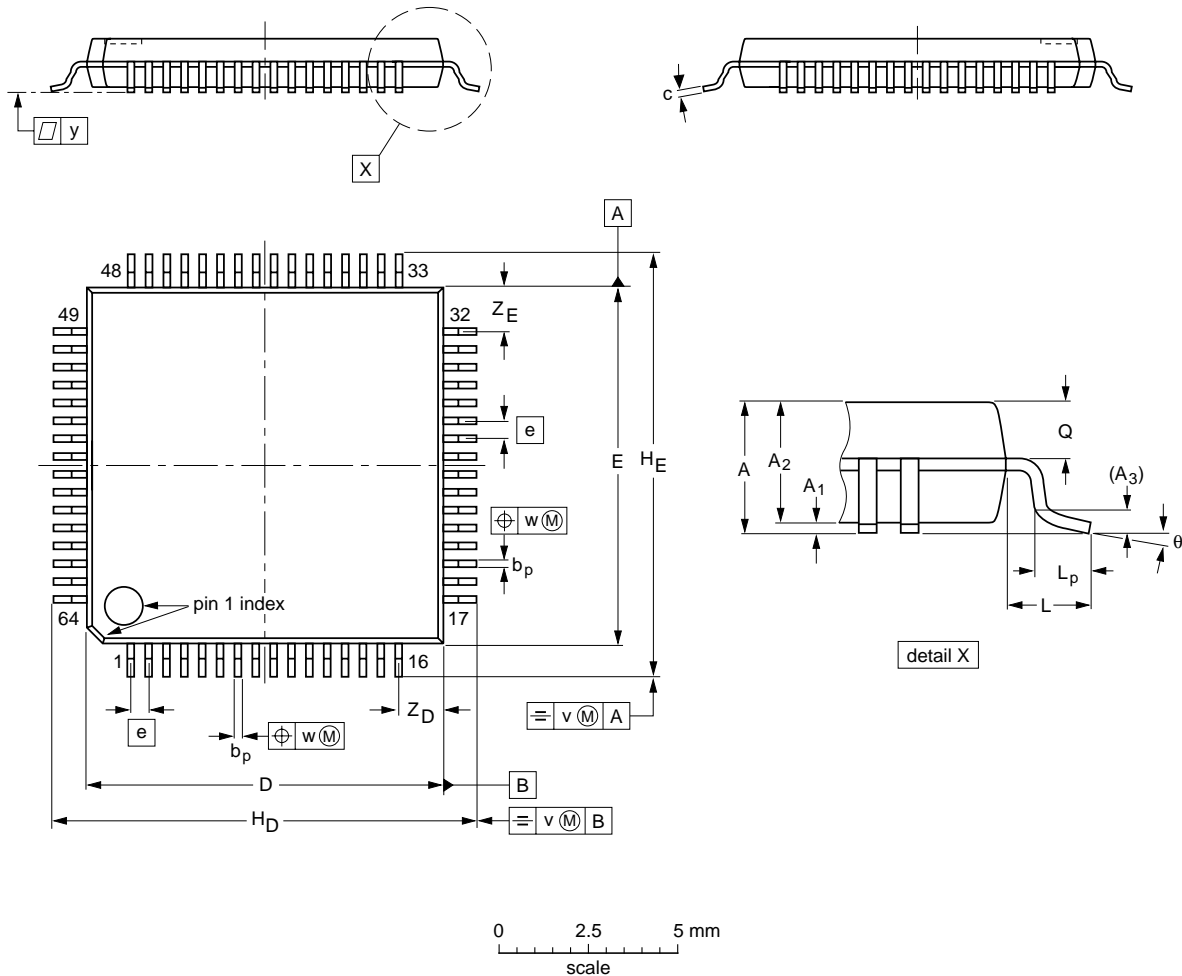

DIMENSIONS (mm are the original dimensions)

UNIT	A max.	A ₁	A ₂	A ₃	b _p	c	D ⁽¹⁾	E ⁽¹⁾	e	H _D	H _E	L	L _p	Q	v	w	y	Z _D ⁽¹⁾	Z _E ⁽¹⁾	θ
mm	1.60	0.20 0.05	1.45 1.35	0.25	0.27 0.17	0.18 0.12	10.1 9.9	10.1 9.9	0.5	12.15 11.85	12.15 11.85	1.0	0.75 0.45	0.69 0.59	0.2	0.12	0.1	1.45 1.05	1.45 1.05	7° 0°

Note

1. Plastic or metal protrusions of 0.25 mm maximum per side are not included.

OUTLINE VERSION	REFERENCES				EUROPEAN PROJECTION	ISSUE DATE
	IEC	JEDEC	EIAJ			
SOT314-2						94-01-07 95-12-19

LCD row/column driver for dot matrix graphic displays

PCF8578

18 SOLDERING

18.1 Introduction

There is no soldering method that is ideal for all IC packages. Wave soldering is often preferred when through-hole and surface mounted components are mixed on one printed-circuit board. However, wave soldering is not always suitable for surface mounted ICs, or for printed-circuits with high population densities. In these situations reflow soldering is often used.

This text gives a very brief insight to a complex technology. A more in-depth account of soldering ICs can be found in our "IC Package Databook" (order code 9398 652 90011).

18.2 Reflow soldering

Reflow soldering techniques are suitable for all LQFP and VSO packages.

Reflow soldering requires solder paste (a suspension of fine solder particles, flux and binding agent) to be applied to the printed-circuit board by screen printing, stencilling or pressure-syringe dispensing before package placement.

Several techniques exist for reflowing; for example, thermal conduction by heated belt. Dwell times vary between 50 and 300 seconds depending on heating method. Typical reflow temperatures range from 215 to 250 °C.

Preheating is necessary to dry the paste and evaporate the binding agent. Preheating duration: 45 minutes at 45 °C.

18.3 Wave soldering

18.3.1 LQFP

Wave soldering is **not** recommended for LQFP packages. This is because of the likelihood of solder bridging due to closely-spaced leads and the possibility of incomplete solder penetration in multi-lead devices.

If wave soldering cannot be avoided, the following conditions must be observed:

- **A double-wave (a turbulent wave with high upward pressure followed by a smooth laminar wave) soldering technique should be used.**

- **The footprint must be at an angle of 45° to the board direction and must incorporate solder thieves downstream and at the side corners.**

Even with these conditions, do not consider wave soldering LQFP packages LQFP48 (SOT313-2), LQFP64 (SOT314-2) or LQFP80 (SOT315-1).

18.3.2 VSO

Wave soldering techniques can be used for all VSO packages if the following conditions are observed:

- A double-wave (a turbulent wave with high upward pressure followed by a smooth laminar wave) soldering technique should be used.
- The longitudinal axis of the package footprint must be parallel to the solder flow.
- The package footprint must incorporate solder thieves at the downstream end.

18.3.3 METHOD (LQFP AND VSO)

During placement and before soldering, the package must be fixed with a droplet of adhesive. The adhesive can be applied by screen printing, pin transfer or syringe dispensing. The package can be soldered after the adhesive is cured.

Maximum permissible solder temperature is 260 °C, and maximum duration of package immersion in solder is 10 seconds, if cooled to less than 150 °C within 6 seconds. Typical dwell time is 4 seconds at 250 °C.

A mildly-activated flux will eliminate the need for removal of corrosive residues in most applications.

18.4 Repairing soldered joints

Fix the component by first soldering two diagonally-opposite end leads. Use only a low voltage soldering iron (less than 24 V) applied to the flat part of the lead. Contact time must be limited to 10 seconds at up to 300 °C. When using a dedicated tool, all other leads can be soldered in one operation within 2 to 5 seconds between 270 and 320 °C.

LCD row/column driver for dot matrix graphic displays

PCF8578

19 DEFINITIONS

Data sheet status	
Objective specification	This data sheet contains target or goal specifications for product development.
Preliminary specification	This data sheet contains preliminary data; supplementary data may be published later.
Product specification	This data sheet contains final product specifications.
Limiting values	
Limiting values given are in accordance with the Absolute Maximum Rating System (IEC 134). Stress above one or more of the limiting values may cause permanent damage to the device. These are stress ratings only and operation of the device at these or at any other conditions above those given in the Characteristics sections of this specification is not implied. Exposure to limiting values for extended periods may affect device reliability.	
Application information	
Where application information is given, it is advisory and does not form part of the specification.	

20 LIFE SUPPORT APPLICATIONS

These products are not designed for use in life support appliances, devices, or systems where malfunction of these products can reasonably be expected to result in personal injury. Philips customers using or selling these products for use in such applications do so at their own risk and agree to fully indemnify Philips for any damages resulting from such improper use or sale.

21 PURCHASE OF PHILIPS I²C COMPONENTS



Purchase of Philips I²C components conveys a license under the Philips' I²C patent to use the components in the I²C system provided the system conforms to the I²C specification defined by Philips. This specification can be ordered using the code 9398 393 40011.

Philips Semiconductors – a worldwide company

Argentina: see South America

Australia: 34 Waterloo Road, NORTH RYDE, NSW 2113,
Tel. +61 2 9805 4455, Fax. +61 2 9805 4466

Austria: Computerstr. 6, A-1101 WIEN, P.O. Box 213,
Tel. +43 1 60 101, Fax. +43 1 60 101 1210

Belarus: Hotel Minsk Business Center, Bld. 3, r. 1211, Volodarski Str. 6,
220050 MINSK, Tel. +375 172 200 733, Fax. +375 172 200 773

Belgium: see The Netherlands

Brazil: see South America

Bulgaria: Philips Bulgaria Ltd., Energoproject, 15th floor,
51 James Bourchier Blvd., 1407 SOFIA,
Tel. +359 2 689 211, Fax. +359 2 689 102

Canada: PHILIPS SEMICONDUCTORS/COMPONENTS,
Tel. +1 800 234 7381

China/Hong Kong: 501 Hong Kong Industrial Technology Centre,
72 Tat Chee Avenue, Kowloon Tong, HONG KONG,
Tel. +852 2319 7888, Fax. +852 2319 7700

Colombia: see South America

Czech Republic: see Austria

Denmark: Prags Boulevard 80, PB 1919, DK-2300 COPENHAGEN S,
Tel. +45 32 88 2636, Fax. +45 31 57 1949

Finland: Sinikalliontie 3, FIN-02630 ESPOO,
Tel. +358 9 615800, Fax. +358 9 61580/xxx

France: 4 Rue du Port-aux-Vins, BP317, 92156 SURESNES Cedex,
Tel. +33 1 40 99 6161, Fax. +33 1 40 99 6427

Germany: Hammerbrookstraße 69, D-20097 HAMBURG,
Tel. +49 40 23 53 60, Fax. +49 40 23 536 300

Greece: No. 15, 25th March Street, GR 17778 TAVROS/ATHENS,
Tel. +30 1 4894 339/239, Fax. +30 1 4814 240

Hungary: see Austria

India: Philips INDIA Ltd, Shivsagar Estate, A Block, Dr. Annie Besant Rd.
Worli, MUMBAI 400 018, Tel. +91 22 4938 541, Fax. +91 22 4938 722

Indonesia: see Singapore

Ireland: Newstead, Clonskeagh, DUBLIN 14,
Tel. +353 1 7640 000, Fax. +353 1 7640 200

Israel: RAPAC Electronics, 7 Kehilat Saloniki St, TEL AVIV 61180,
Tel. +972 3 645 0444, Fax. +972 3 649 1007

Italy: PHILIPS SEMICONDUCTORS, Piazza IV Novembre 3,
20124 MILANO, Tel. +39 2 6752 2531, Fax. +39 2 6752 2557

Japan: Philips Bldg 13-37, Kohnan 2-chome, Minato-ku, TOKYO 108,
Tel. +81 3 3740 5130, Fax. +81 3 3740 5077

Korea: Philips House, 260-199 Itaewon-dong, Yongsan-ku, SEOUL,
Tel. +82 2 709 1412, Fax. +82 2 709 1415

Malaysia: No. 76 Jalan Universiti, 46200 PETALING JAYA, SELANGOR,
Tel. +60 3 750 5214, Fax. +60 3 757 4880

Mexico: 5900 Gateway East, Suite 200, EL PASO, TEXAS 79905,
Tel. +9-5 800 234 7381

Middle East: see Italy

Netherlands: Postbus 90050, 5600 PB EINDHOVEN, Bldg. VB,
Tel. +31 40 27 82785, Fax. +31 40 27 88399

New Zealand: 2 Wagener Place, C.P.O. Box 1041, AUCKLAND,
Tel. +64 9 849 4160, Fax. +64 9 849 7811

Norway: Box 1, Manglerud 0612, OSLO,
Tel. +47 22 74 8000, Fax. +47 22 74 8341

Philippines: Philips Semiconductors Philippines Inc.,
106 Valero St. Salcedo Village, P.O. Box 2108 MCC, MAKATI,
Metro MANILA, Tel. +63 2 816 6380, Fax. +63 2 817 3474

Poland: Ul. Lukiska 10, PL 04-123 WARSZAWA,
Tel. +48 22 612 2831, Fax. +48 22 612 2327

Portugal: see Spain

Romania: see Italy

Russia: Philips Russia, Ul. Usatcheva 35A, 119048 MOSCOW,
Tel. +7 095 755 6918, Fax. +7 095 755 6919

Singapore: Lorong 1, Toa Payoh, SINGAPORE 1231,
Tel. +65 350 2538, Fax. +65 251 6500

Slovakia: see Austria

Slovenia: see Italy

South Africa: S.A. PHILIPS Pty Ltd., 195-215 Main Road Martindale,
2092 JOHANNESBURG, P.O. Box 7430 Johannesburg 2000,
Tel. +27 11 470 5911, Fax. +27 11 470 5494

South America: Rua do Rocio 220, 5th floor, Suite 51,
04552-903 São Paulo, SÃO PAULO - SP, Brazil,
Tel. +55 11 821 2333, Fax. +55 11 829 1849

Spain: Balmes 22, 08007 BARCELONA,
Tel. +34 3 301 6312, Fax. +34 3 301 4107

Sweden: Kottbygatan 7, Akalla, S-16485 STOCKHOLM,
Tel. +46 8 632 2000, Fax. +46 8 632 2745

Switzerland: Allmendstrasse 140, CH-8027 ZÜRICH,
Tel. +41 1 488 2686, Fax. +41 1 481 7730

Taiwan: Philips Semiconductors, 6F, No. 96, Chien Kuo N. Rd., Sec. 1,
TAIPEI, Taiwan Tel. +886 2 2134 2870, Fax. +886 2 2134 2874

Thailand: PHILIPS ELECTRONICS (THAILAND) Ltd.,
209/2 Sanpavuth-Bangna Road Prakanong, BANGKOK 10260,
Tel. +66 2 745 4090, Fax. +66 2 398 0793

Turkey: Talatpasa Cad. No. 5, 80640 GÜLTEPE/ISTANBUL,
Tel. +90 212 279 2770, Fax. +90 212 282 6707

Ukraine: PHILIPS UKRAINE, 4 Patrice Lumumba str., Building B, Floor 7,
252042 KIEV, Tel. +380 44 264 2776, Fax. +380 44 268 0461

United Kingdom: Philips Semiconductors Ltd., 276 Bath Road, Hayes,
MIDDLESEX UB3 5BX, Tel. +44 181 730 5000, Fax. +44 181 754 8421

United States: 811 East Arques Avenue, SUNNYVALE, CA 94088-3409,
Tel. +1 800 234 7381

Uruguay: see South America

Vietnam: see Singapore

Yugoslavia: PHILIPS, Trg N. Pasica 5/v, 11000 BEOGRAD,
Tel. +381 11 625 344, Fax. +381 11 635 777

For all other countries apply to: Philips Semiconductors, Marketing & Sales Communications,
Building BE-p, P.O. Box 218, 5600 MD EINDHOVEN, The Netherlands, Fax. +31 40 27 24825

Internet: <http://www.semiconductors.philips.com>

© Philips Electronics N.V. 1997

SCA53

All rights are reserved. Reproduction in whole or in part is prohibited without the prior written consent of the copyright owner.

The information presented in this document does not form part of any quotation or contract, is believed to be accurate and reliable and may be changed without notice. No liability will be accepted by the publisher for any consequence of its use. Publication thereof does not convey nor imply any license under patent- or other industrial or intellectual property rights.

Printed in The Netherlands

417067/1200/03/pp44

Date of release: 1997 Mar 28

Document order number: 9397 750 01756

Let's make things better.

**Philips
Semiconductors**



PHILIPS