

# DATA SHEET

## **PCK2000M**

**CK97 (66/100MHz) Mobile System Clock  
Generator**

Product specification

1998 Sep 29

# CK97 (66/100MHz) Mobile System Clock Generator

# PCK2000M

## FEATURES

- Reduced pincount version of PCK2000 for mobile applications
- Mixed 2.5V and 3.3V operation
- Two CPU clocks at 2.5V
- Six synchronous PCI clocks at 3.3V, one free-running
- One 3.3V reference clock @ 14.318 MHz
- Reference 14.31818 MHz Xtal oscillator input
- 100 MHz or 66 MHz operation
- Power management control input pins
- 175 ps CPU clock jitter
- 175 ps skew on outputs
- Available in 28-pin SSOP package
- 1.5 – 4ns CPU-PCI delay
- Power down if PWRDWN is held LOW
- See PCK2000 for 48-pin version

## PIN CONFIGURATION

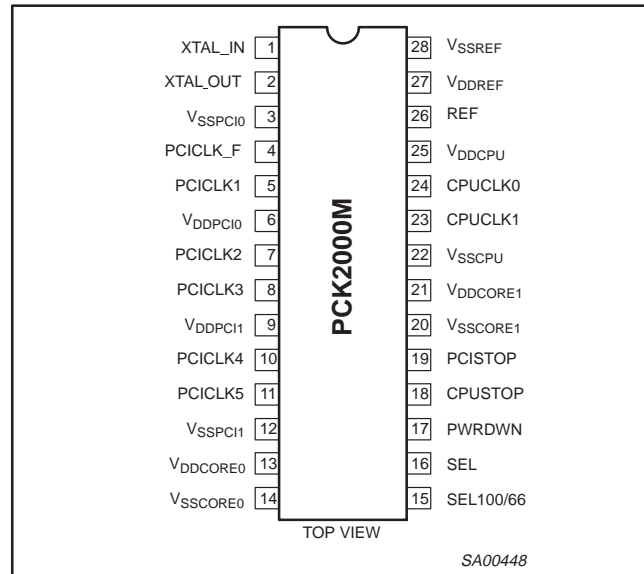

## DESCRIPTION

The PCK2000M is a clock synthesizer/driver chip for a Pentium Pro or other similar processors, typically used in mobile applications.

The PCK2000M has two CPU clock outputs at 2.5V. There are six PCI clock outputs running at 33 MHz. One of the PCI clock outputs is free-running. The 3.3V reference clock outputs at 14.318 MHz. All clock outputs meet Intel's drive strength, rise/fall time, jitter, accuracy, and skew requirements.

The part possesses dedicated powerdown, CPUSTOP, and PCISTOP input pins for power management control. These inputs are synchronized on-chip and ensure glitch-free output transitions. When the CPUSTOP input is asserted, the CPU clock outputs are driven LOW. When the PCISTOP inputs is asserted, the PCI clock outputs are driven LOW.

Finally, when the PWRDWN input pin is asserted, the internal reference oscillator and PLLs are shut down, and all outputs are driven LOW, except the free running PCICLK\_F clock output.

The PCK2000M is available in a 28-pin SSOP package.

## ORDERING INFORMATION

PACKAGES	TEMPERATURE RANGE	OUTSIDE NORTH AMERICA	NORTH AMERICA	DRAWING NUMBER
28-Pin Plastic SSOP	0°C to +70°C	PCK2000M DB	PCK2000M DB	SOT341-1

Intel and Pentium are registered trademarks of Intel Corporation.

# CK97 (66/100MHz) Mobile System Clock Generator

# PCK2000M

## PIN DESCRIPTION

PIN NUMBER	SYMBOL	FUNCTION
26	REF	14.318 MHz clock output
28	V <sub>SSREF</sub>	GROUND for REF output
27	V <sub>DDREF</sub>	POWER for REF output
1	XTAL_IN	14.318 MHz crystal input
2	XTAL_OUT	14.318 MHz crystal output
3, 12	V <sub>SSPCI</sub> [0-1]	GROUND for PCI outputs
4	PCICLK_F	Free-running PCI output
6, 9	V <sub>DDPCI</sub> [0-1]	POWER for PCI outputs
5, 7, 8, 10, 11	PCICLK [1-5]	PCI clock outputs.
13, 21	V <sub>DDCORE</sub> [0-1]	Isolated POWER for core
14, 20	V <sub>SSCORE</sub> [0-1]	Isolated GROUND for core
16	SEL	Logic select pins
15	SEL100/66	Select pin for enabling 66 MHz or 100MHz or 66 MHz. L = 66 Mhz H = 100MHz
17	PWRDWN	Control pin to put device in powerdown state, active low
18	CPUSTOP	Control pin to disable CPU clocks, active low
19	PCISTOP	Control pin to disable PCI clocks, active low
25	V <sub>DDCPU</sub>	Power for CPU outputs
22	V <sub>SSCPU</sub>	GROUND for CPU outputs
23, 24	CPUCLK [0-1]	CPU and Host clock outputs 2.5V

**NOTE:**

1. V<sub>DD</sub> and V<sub>SS</sub> names in the above tables reflects a likely internal POWER and GROUND partition to reduce the effects of internal noise on the performance of the device. In reality, the platform will be configured with the V<sub>DDCPU</sub> pins tied to a 2.5V supply, all remaining V<sub>DD</sub> pins tied to a common 3.3V supply and all V<sub>SS</sub> pins being common.

## BLOCK DIAGRAM

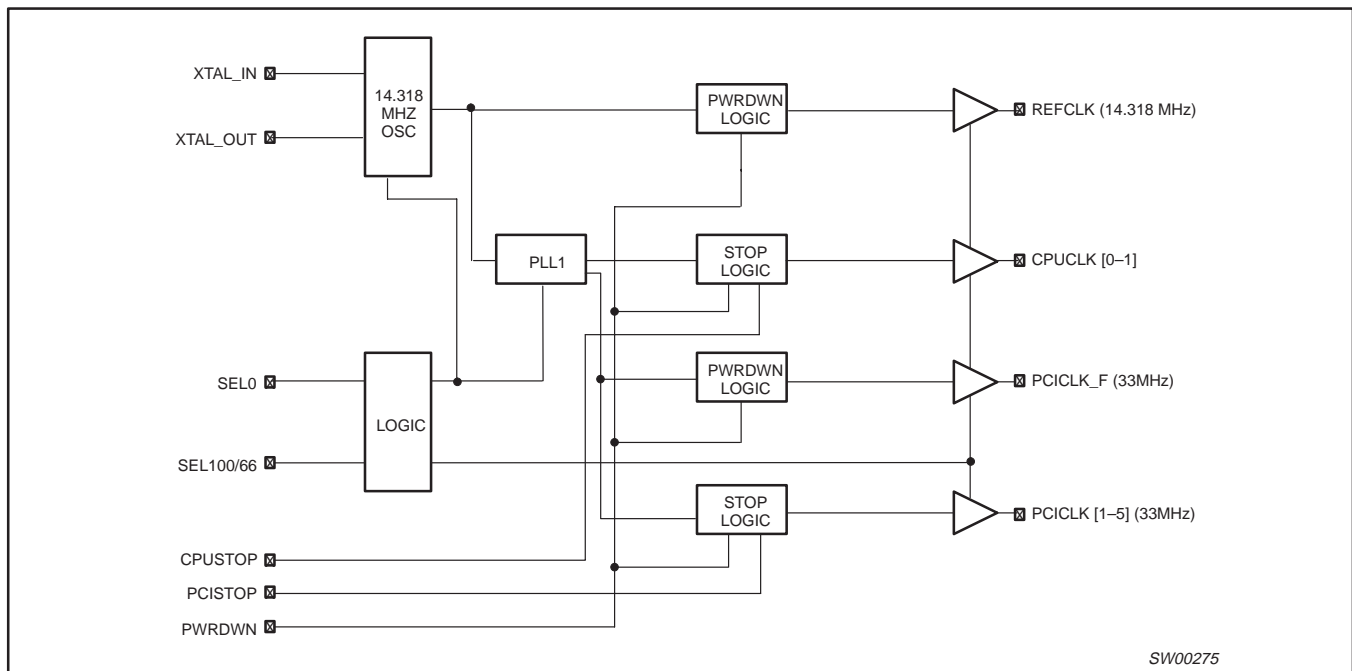

## CK97 (66/100MHz) Mobile System Clock Generator

PCK2000M

## SELECT FUNCTIONS

SEL100/66	SEL0	FUNCTION	NOTES
0	0	TRI-State	1
0	1	Active 66MHz	
1	0	Test mode	1
1	1	Active 100MHz	

## NOTES:

- Internal decode logic for all two select inputs implemented.

FUNCTION DESCRIPTION	OUTPUTS		
	CPU	PCI, PCI_F	REF
Tri-State	Hi-Z	Hi-Z	Hi-Z
Test mode	TCLK/2	TCLK/6	TCLK

## FUNCTION TABLE

SEL 100/66	CPU/PCI RATIO	CPUCLK (0-1) (MHz)	CPICLK (1-5) PCICLK_F (MHz)	REF (MHz)
0	2	66.66	33.33	14.318
1	3	100	33.33	14.318

## CLOCK ENABLE CONFIGURATION

CPUSTOP	PCISTOP	PWRDWN	CPUCLK	PCICLK	PCICLK_F	OTHER CLOCKS	PLL	OSCILLATOR
X	X	0	LOW	LOW	LOW	Stopped	OFF	OFF
0	0	1	LOW	LOW	33MHz	Running	Running	Running
0	1	1	LOW	33MHz	33MHz	Running	Running	Running
1	0	1	100/66MHz	LOW	33MHz	Running	Running	Running
1	1	1	100/66MHz	33MHz	33MHz	Running	Running	Running

## POWER MANAGEMENT REQUIREMENTS

SIGNAL	SIGNAL STATE	LATENCY
		NO. OF RISING EDGES OF FREE RUNNING PCICLK
CPUSTOP	0 (DISABLED)	1
	1 (ENABLED)	1
PCISTOP	0 (DISABLED)	1
	1 (ENABLED)	1
PWRDWN	1 (NORMAL OPERATION)	3ms
	0 (POWER DOWN)	2 MAX

## NOTES:

- Clock ON/OFF latency is defined as the number of rising edges of free running PCICLKs between the clock disable goes HIGH/LOW to the first valid clock that comes out of the device.
- Power up latency is when PWRDWN goes inactive (HIGH) to when the first valid clocks are driven from the device.

## CK97 (66/100MHz) Mobile System Clock Generator

## PCK2000M

**ABSOLUTE MAXIMUM RATINGS<sup>1, 2</sup>**

In accordance with the Absolute Maximum Rating System (IEC 134)

Voltages are referenced to  $V_{SS}$  ( $V_{SS} = 0V$ )

SYMBOL	PARAMETER	CONDITION	LIMITS		UNIT
			MIN	MAX	
$V_{DD3}$	DC 3.3V core supply voltage		-0.5	+4.6	V
$V_{DDQ3}$	DC 3.3V I/O supply voltage		-0.5	+4.6	V
$V_{DDQ2}$	DC 2.5V I/O supply voltage		-0.5	+3.6	V
$I_{IK}$	DC input diode current	$V_I < 0$		-50	mA
$V_I$	DC input voltage	Note 2	-0.5	5.5	V
$I_{OK}$	DC output diode current	$V_O > V_{CC}$ or $V_O < 0$		$\pm 50$	mA
$V_O$	DC output voltage	Note 2	-0.5	$V_{CC} + 0.5$	V
$I_O$	DC output source or sink current	$V_O \geq 0$ to $V_{CC}$		$\pm 50$	mA
$T_{STG}$	Storage temperature range		-65	+150	$^{\circ}C$
$P_{TOT}$	Power dissipation per package plastic medium-shrink (SSOP)	For temperature range: -40 to +125 $^{\circ}C$ above +55 $^{\circ}C$ derate linearly with 11.3mW/K		850	mW

**NOTES:**

- Stresses beyond those listed may cause permanent damage to the device. These are stress ratings only and functional operation of the device at these or any other conditions beyond those indicated under "recommended operating conditions" is not implied. Exposure to absolute-maximum-rated conditions for extended periods may affect device reliability.
- The input and output voltage ratings may be exceeded if the input and output current ratings are observed.

**RECOMMENDED OPERATING CONDITIONS**

SYMBOL	PARAMETER	CONDITIONS	LIMITS		UNIT
			MIN	MAX	
$V_{DD3}$	DC 3.3V core supply voltage	Note 1	3.135	3.465	V
$V_{DDQ3}$	DC 3.3V I/O supply voltage	Note 2	3.135	3.465	V
$V_{DDQ2}$	DC 2.5V I/O supply voltage	Note 3	2.135	2.625	V
$V_I$	DC input voltage range		0	$V_{DD3}$	V
$V_O$	DC output voltage range		0	$V_{DDQ2}$ $V_{DDQ3}$	V
$T_{amb}$	Operating ambient temperature range in free air		0	+70	$^{\circ}C$

**NOTES:**

- $V_{DD3} = V_{DDCORE1} = V_{DDCORE2} = 3.3V$
- $V_{DDQ3} = V_{DDREF} = V_{DDPCI0} = 3.3V$
- $V_{DDQ2} = V_{DDCPU0} = V_{DDCPU1} = 2.5V$

## CK97 (66/100MHz) Mobile System Clock Generator

## PCK2000M

## DC CHARACTERISTICS

SYMBOL	PARAMETER	TEST CONDITIONS			LIMITS			UNIT
		$T_{amb} = 0^{\circ}\text{C to } +70^{\circ}\text{C}$			MIN	TYP	MAX	
		$V_{DD}$ (V)	OTHER					
$V_{IH}$	HIGH level input voltage	3.135 to 3.465		$V_{DDQ2} = 2.5\text{V} \pm 5\%$	2.0		$V_{DD} + 0.3$	V
$V_{IL}$	LOW level input voltage	3.135 to 3.465		$V_{DDQ3} = 3.3\text{V} \pm 5\%$	$V_{SS} - 0.3$		0.8	V
$V_{OH2}$	2.5V output HIGH voltage CPUCLK	2.375 to 2.625	$I_{OH} = -1\text{mA}$	$V_{DDQ3} = 3.3\text{V} \pm 5\%$	2.0		–	V
$V_{OL2}$	2.5V output LOW voltage CPUCLK	2.375 to 2.625	$I_{OL} = 1\text{mA}$		–		0.4	V
$V_{OH3}$	3.3V output HIGH voltage REF	3.135 to 3.465	$I_{OH} = -1\text{mA}$		2.0		–	V
$V_{OL3}$	3.3V output LOW voltage REF	3.135 to 3.465	$I_{OL} = 1\text{mA}$		–		0.4	V
$V_{POH}$	PCI output HIGH voltage	3.135 to 3.465	$I_{OH} = -1\text{mA}$		2.4		–	V
$V_{POL}$	PCI output LOW voltage	3.135 to 3.465	$I_{OL} = 1\text{mA}$		–		0.55	V
$I_{OH}$	CPUCLK output HIGH current	2.375	$V_{OUT} = 1.0\text{V}$		–27		–	mA
		2.625	$V_{OUT} = 2.375\text{V}$		–		–27	
$I_{OH}$	PCI output HIGH current	3.135	$V_{OUT} = 1.0\text{V}$		–33		–	mA
		3.465	$V_{OUT} = 3.135\text{V}$		–		–33	
$I_{OL}$	CPUCLK output LOW current	2.375	$V_{OUT} = 1.2\text{V}$		27		–	mA
		2.625	$V_{OUT} = 0.3\text{V}$		–		30	
$I_{OL}$	PCI output LOW current	3.135	$V_{OUT} = 1.95\text{V}$		30		–	mA
		3.465	$V_{OUT} = 0.4\text{V}$		–		38	
$\pm I_I$	Input leakage current	3.465			–		5	$\mu\text{A}$
$\pm I_{OZ}$	3-State output OFF-State current	3.465	$V_{OUT} =$ $V_{dd}$ or GND	$I_O = 0$	–		10	$\mu\text{A}$
$C_{in}$	Input pin capacitance						5	pF
$C_{xtal}$	Xtal pin capacitance, as seen by external crystal					18		pF
$C_{out}$	Output pin capacitance						6	pF
$I_{dd3}$	Operating supply current	3.465	66MHz mode	Outputs loaded <sup>1</sup>			170	mA
			100MHz mode	Outputs loaded <sup>1</sup>			170	mA
	Powerdown supply current		All static inputs to $V_{DD}$ or GND				500	$\mu\text{A}$
$I_{dd2}$	Operating supply current	2.625	66MHz mode	Output loaded <sup>1</sup>			72	mA
			100MHz mode	Output loaded <sup>1</sup>			100	mA
	Powerdown supply current		All static inputs to $V_{DD}$ or GND				100	$\mu\text{A}$

## NOTE:

1. All clock outputs loaded with maximum lump capacitance test load specified in AC characteristics section.

## CK97 (66/100MHz) Mobile System Clock Generator

## PCK2000M

**AC CHARACTERISTICS**VDDREF = VDDPCI (0-1) = 3.3V ± 5%; VDDCPU = 2.5V ± 5%; f<sub>crystal</sub> = 14.31818 MHz**CPU CLOCK OUTPUTS, CPU(0-3) (LUMP CAPACITANCE TEST LOAD = 20pF)**

SYMBOL	PARAMETER	TEST CONDITIONS		LIMITS T <sub>amb</sub> = 0°C to +70°C		UNIT
			NOTES	MIN	MAX	
T <sub>HKP</sub> (t <sub>P</sub> )	CPUCLK period	66MHz	2	15.0	15.5	ns
T <sub>HKH</sub> (t <sub>H</sub> )	CPUCLK HIGH time		1, 5	5.2		
T <sub>HKL</sub> (t <sub>L</sub> )	CPUCLK LOW time		1, 5	5.0		
T <sub>HKP</sub> (t <sub>P</sub> )	CPUCLK period	100MHz	2	10.0	10.5	ns
T <sub>HKH</sub> (t <sub>H</sub> )	CPUCLK HIGH time		1, 5	3.0		
T <sub>HKL</sub> (t <sub>L</sub> )	CPUCLK LOW time		1, 5	2.8		
T <sub>HRISE</sub> (t <sub>R</sub> )	CPUCLK rise time		9	0.4	1.6	ns
T <sub>HFALL</sub> (t <sub>F</sub> )	CPUCLK fall time		9	0.4	1.6	ns
T <sub>JITTER</sub> (t <sub>JC</sub> )	CPUCLK jitter				175	ps
DUTY CYCLE (t <sub>D</sub> )	Output Duty Cycle		1	45	55	%
T <sub>HSKW</sub> (t <sub>SK</sub> )	CPU Bus CLK skew		2		175	ps
T <sub>HSTB</sub> (f <sub>ST</sub> )	CPUCLK stabilization from Power-up		7		3	ms

**PCI CLOCK OUTPUTS, PCI(1-5) AND PCI\_F (LUMP CAPACITANCE TEST LOAD = 30pF)**

SYMBOL	PARAMETER	TEST CONDITIONS		LIMITS T <sub>amb</sub> = 0°C to +70°C		UNIT
			NOTES	MIN	MAX	
T <sub>PKP</sub> (t <sub>P</sub> )	PCICLK period		3	30.0		ns
T <sub>PKPS</sub>	PCICLK period stability		8		500	ps
T <sub>PKH</sub> (t <sub>H</sub> )	PCICLK HIGH time		1	12.0		ns
T <sub>PKL</sub> (t <sub>L</sub> )	PCICLK LOW time		1	12.0		ns
T <sub>HRISE</sub> (t <sub>R</sub> )	PCICLK rise time		10	0.5	2.0	ns
T <sub>HFALL</sub> (t <sub>F</sub> )	PCICLK fall time		10	0.5	2.0	ns
T <sub>PSKW</sub> (t <sub>SK</sub> )	PCI Bus CLK skew		2		500	ps
T <sub>HPOFFSET</sub> (t <sub>O</sub> )	CPUCLK to PCICLK Offset		2, 4	1.5	4.0	ns
T <sub>PSTB</sub> (f <sub>ST</sub> )	PCICLK stabilization from Power-up		7		3	ms

**REF CLOCK OUTPUT (LUMP CAPACITANCE TEST LOAD = 20pF)**

SYMBOL	PARAMETER	TEST CONDITIONS		LIMITS T <sub>amb</sub> = 0°C to +70°C		UNIT
			NOTES	MIN	MAX	
f	Frequency, Actual	Frequency generated by Crystal		14.31818		MHz
T <sub>HRISE</sub> (t <sub>R</sub> )	Output rise edge rate			1	4	ns
T <sub>HFALL</sub> (t <sub>F</sub> )	Output fall edge rate			1	4	ns
DUTY CYCLE (t <sub>D</sub> )	Duty Cycle			45	55	%
T <sub>HSTB</sub> (f <sub>ST</sub> )	Frequency stabilization from Power-up (cold start)				3	ms

# CK97 (66/100MHz) Mobile System Clock Generator

## PCK2000M

### ALL CLOCK OUTPUTS

SYMBOL	PARAMETER	TEST CONDITIONS		LIMITS $T_{amb} = 0^{\circ}\text{C to } +70^{\circ}\text{C}$		UNIT
			NOTES	MIN	MAX	
$T_{PZL}, T_{PZH}$	Output enable time			1.0	8.0	ns
$T_{PLZ}, T_{PHZ}$	Output disable time			1.0	8.0	ns

**NOTES:**

1. See Figure 3 for measure points.
2. Period, jitter, offset, and skew are measured on the rising edge @ 1.25V for 2.5V clocks and @ 1.5V for 3.3V clocks.
3. The PCICLK is the CPUCLK divided by two at CPUCLK = 66.6MHz. PCICLK is the CPUCLK divided by three at CPUCLK = 100MHz.
4. The CPUCLK must always lead the PCICLK as shown in Figure 2.
5.  $T_{HKH}$  is measured @ 2.0V as shown in Figure 4.
6.  $T_{HKL}$  is measured @ 0.4V as shown in Figure 4.
7. The time is specified from when  $V_{DDQ}$  achieves its nominal operating level (typical condition is  $V_{DDQ} = 3.3\text{V}$ ) until the frequency output is stable and operating within specification.
8. Defined as once the clock is at its nominal operating frequency, the adjacent period changes cannot exceed the time specified.
9.  $T_{HRISE}$  and  $T_{HFALL}$  are measured as a transition through the threshold region  $V_{OL} = 0.4\text{V}$  and  $V_{OH} = 2.0\text{V}$  (1mA) JEDEC specification.
10.  $T_{HRISE}$  and  $T_{HFALL}$  (REF, PCI) are measured as a transition through the threshold region  $V_{OL} = 0.4\text{V}$  and  $V_{OH} = 2.4\text{V}$

### AC WAVEFORMS

$V_M = 1.25\text{V}$  @  $V_{DDQ2}$  and  $1.5\text{V}$  @  $V_{DDQ3}$

$V_X = V_{OL} + 0.3\text{V}$

$V_Y = V_{OH} - 0.3\text{V}$

$V_{OL}$  and  $V_{OH}$  are the typical output voltage drop that occur with the output load.

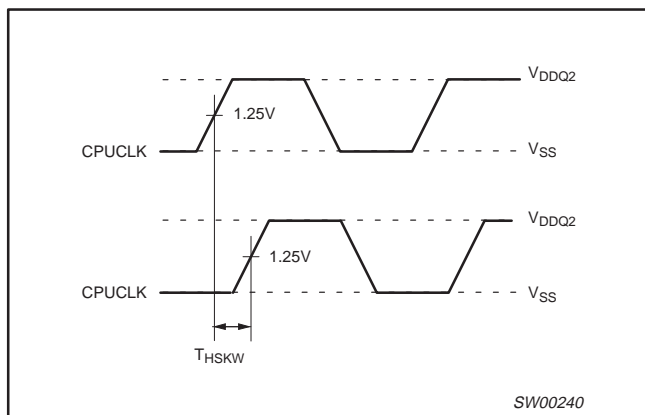

Figure 1. CPUCLK to CPUCLK skew

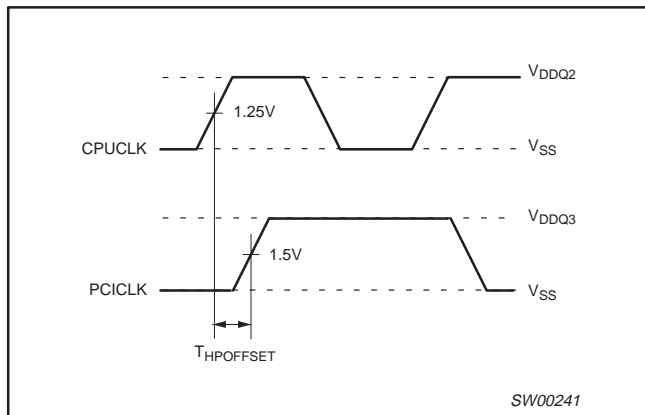

Figure 2. CPUCLK to PCICLK offset

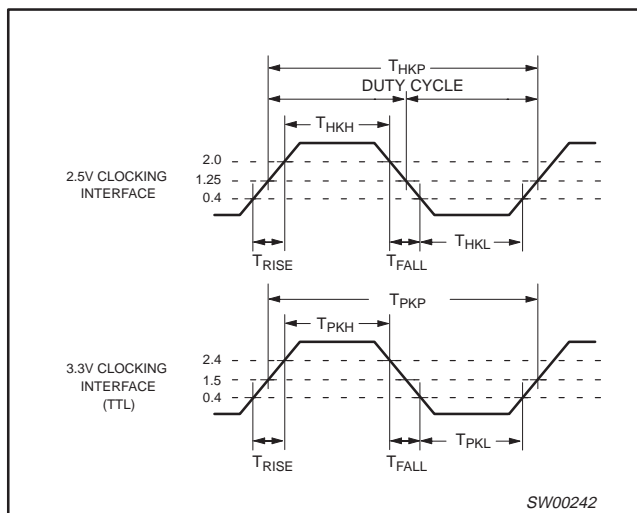

Figure 3. 2.5V/3.3V Clock waveforms



CK97 (66/100MHz) Mobile System Clock Generator

PCK2000M

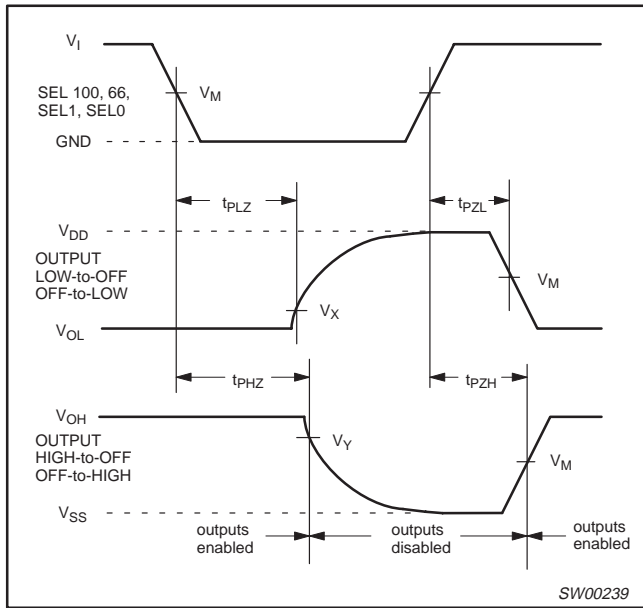

Figure 4. 3-State enable and disable times.

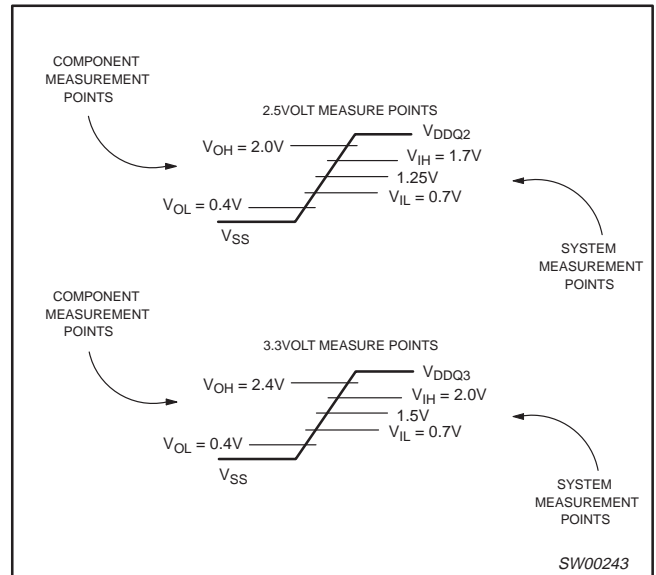
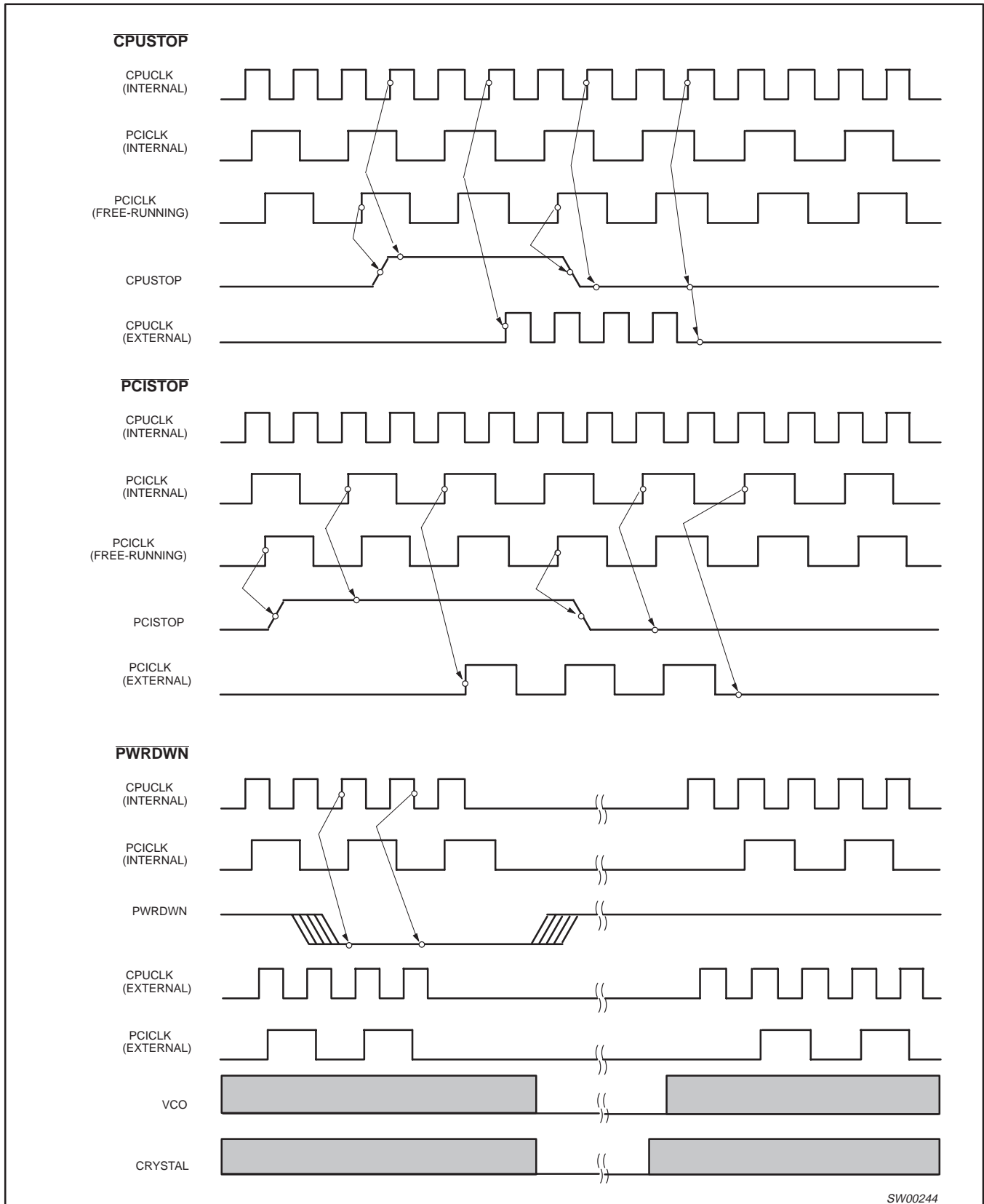

Figure 5. Component versus system measure points

# CK97 (66/100MHz) Mobile System Clock Generator

# PCK2000M



SW00244

Figure 6. Power Management

CK97 (66/100MHz) Mobile System Clock Generator

PCK2000M

SSOP28: plastic shrink small outline package; 28 leads; body width 5.3mm

SOT341-1

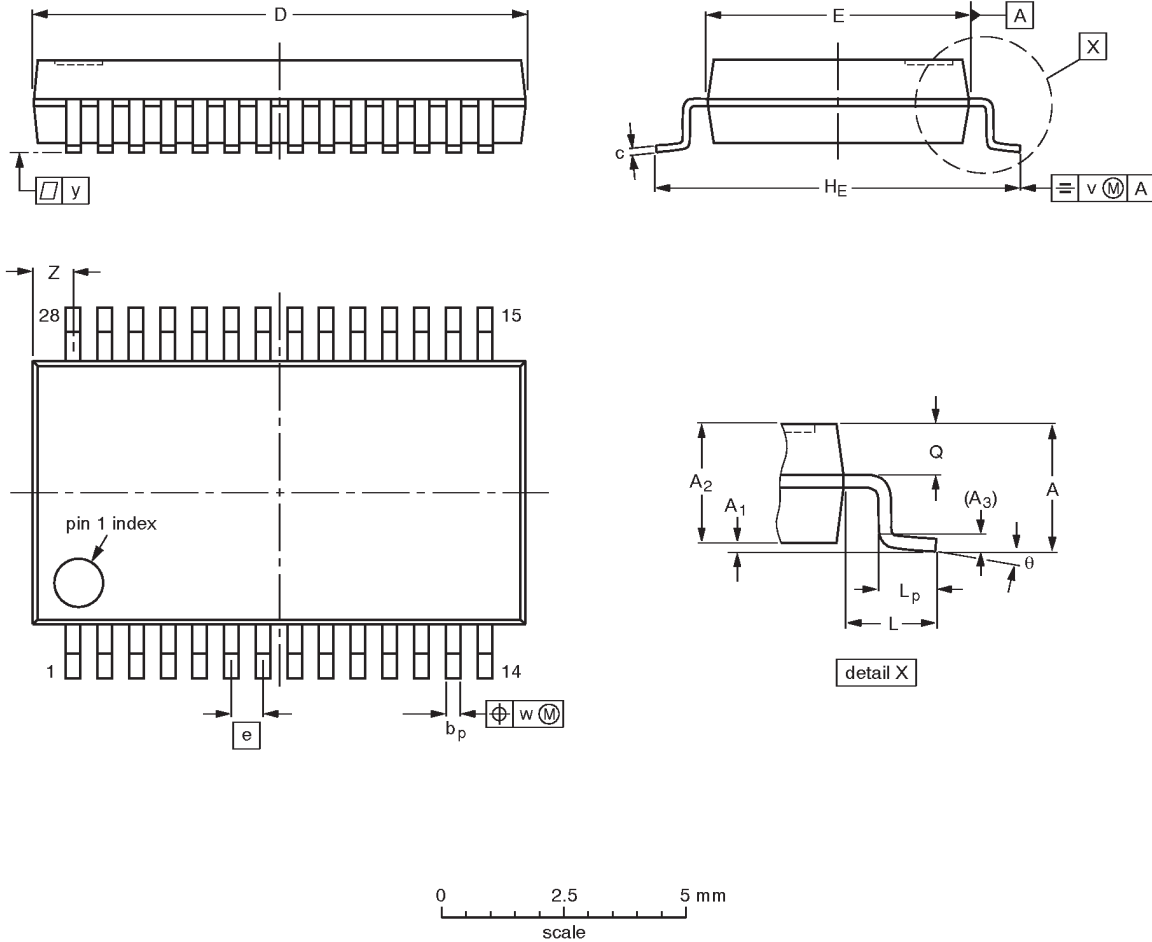

**DIMENSIONS (mm are the original dimensions)**

UNIT	A max.	A <sub>1</sub>	A <sub>2</sub>	A <sub>3</sub>	b <sub>p</sub>	c	D <sup>(1)</sup>	E <sup>(1)</sup>	e	H <sub>E</sub>	L	L <sub>p</sub>	Q	v	w	y	Z <sup>(1)</sup>	θ
mm	2.0	0.21 0.05	1.80 1.65	0.25	0.38 0.25	0.20 0.09	10.4 10.0	5.4 5.2	0.65	7.9 7.6	1.25	1.03 0.63	0.9 0.7	0.2	0.13	0.1	1.1 0.7	8° 0°

**Note**

1. Plastic or metal protrusions of 0.20 mm maximum per side are not included.

OUTLINE VERSION	REFERENCES				EUROPEAN PROJECTION	ISSUE DATE
	IEC	JEDEC	EIAJ			
SOT341-1		MO-150AH				93-09-08 95-02-04

## CK97 (66/100MHz) Mobile System Clock Generator

PCK2000M

## Data sheet status

Data sheet status	Product status	Definition [1]
Objective specification	Development	This data sheet contains the design target or goal specifications for product development. Specification may change in any manner without notice.
Preliminary specification	Qualification	This data sheet contains preliminary data, and supplementary data will be published at a later date. Philips Semiconductors reserves the right to make changes at any time without notice in order to improve design and supply the best possible product.
Product specification	Production	This data sheet contains final specifications. Philips Semiconductors reserves the right to make changes at any time without notice in order to improve design and supply the best possible product.

[1] Please consult the most recently issued datasheet before initiating or completing a design.

## Definitions

**Short-form specification** — The data in a short-form specification is extracted from a full data sheet with the same type number and title. For detailed information see the relevant data sheet or data handbook.

**Limiting values definition** — Limiting values given are in accordance with the Absolute Maximum Rating System (IEC 134). Stress above one or more of the limiting values may cause permanent damage to the device. These are stress ratings only and operation of the device at these or at any other conditions above those given in the Characteristics sections of the specification is not implied. Exposure to limiting values for extended periods may affect device reliability.

**Application information** — Applications that are described herein for any of these products are for illustrative purposes only. Philips Semiconductors make no representation or warranty that such applications will be suitable for the specified use without further testing or modification.

## Disclaimers

**Life support** — These products are not designed for use in life support appliances, devices or systems where malfunction of these products can reasonably be expected to result in personal injury. Philips Semiconductors customers using or selling these products for use in such applications do so at their own risk and agree to fully indemnify Philips Semiconductors for any damages resulting from such application.

**Right to make changes** — Philips Semiconductors reserves the right to make changes, without notice, in the products, including circuits, standard cells, and/or software, described or contained herein in order to improve design and/or performance. Philips Semiconductors assumes no responsibility or liability for the use of any of these products, conveys no license or title under any patent, copyright, or mask work right to these products, and makes no representations or warranties that these products are free from patent, copyright, or mask work right infringement, unless otherwise specified.

Philips Semiconductors  
811 East Arques Avenue  
P.O. Box 3409  
Sunnyvale, California 94088-3409  
Telephone 800-234-7381

© Copyright Philips Electronics North America Corporation 1998  
All rights reserved. Printed in U.S.A.

print code

Date of release: 05-96

Document order number:

9397-750-04604

*Let's make things better.*