

# Xinger®

## Ultra Low Profile 0805 Power Divider 50Ω to 50Ω

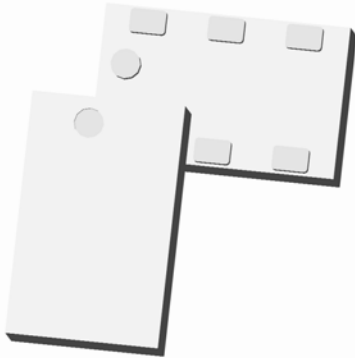

### Description

The PD4859J5050S2HF is a low profile, sub-miniature Wilkinson power divider in an easy to use surface mount package. The PD4859J5050S2HF is ideal for high volume manufacturing and delivers higher performances than traditional printed and lumped element solutions. The PD4859J5050S2HF is matched to 50 Ω and has a height profile of 0.5 mm which is ideal for high level integrations in the following markets: 802.11a, WiMax, and home cordless. The PD4859J5050S2HF does not include the resistive element and therefore, requires an external resistor for operation. The PD4859J5050S2HF is available on tape and reel for high volume manufacturing pick and place.

### Detailed Electrical Specifications: Specifications subject to change without notice.

Features:	Parameter	ROOM (25°C)			Unit
		Min.	Typ.	Max	
• 4800-5900 MHz	Frequency	4800		5900	MHz
• 18 dB Isolation (output ports)	Input Port Impedance		50		Ω
• Good Return Loss	Output Port Impedance		50		Ω
• 0.5mm Height Profile	Return Loss	7.9	10.3		dB
• 50 Ohm Input / 50Ω Outputs	Insertion Loss*		0.7	1.0	dB
• Low Insertion Loss	Amplitude Balance		0.1	0.3	dB
• Surface Mountable	Phase Balance		1	4	Degrees
• Tape & Reel	Isolation (Output Ports)	14	18		dB
• Non-conductive Surface	Power Handling			2	Watts
• RoHS Compliant	Operating Temperature	-55		+85	°C
• External Resistor Required					
• Halogen Free					

\* Insertion Loss stated at room temperature (Insertion Loss is approximately 0.1 dB higher at +85 °C)

### Outline Drawing

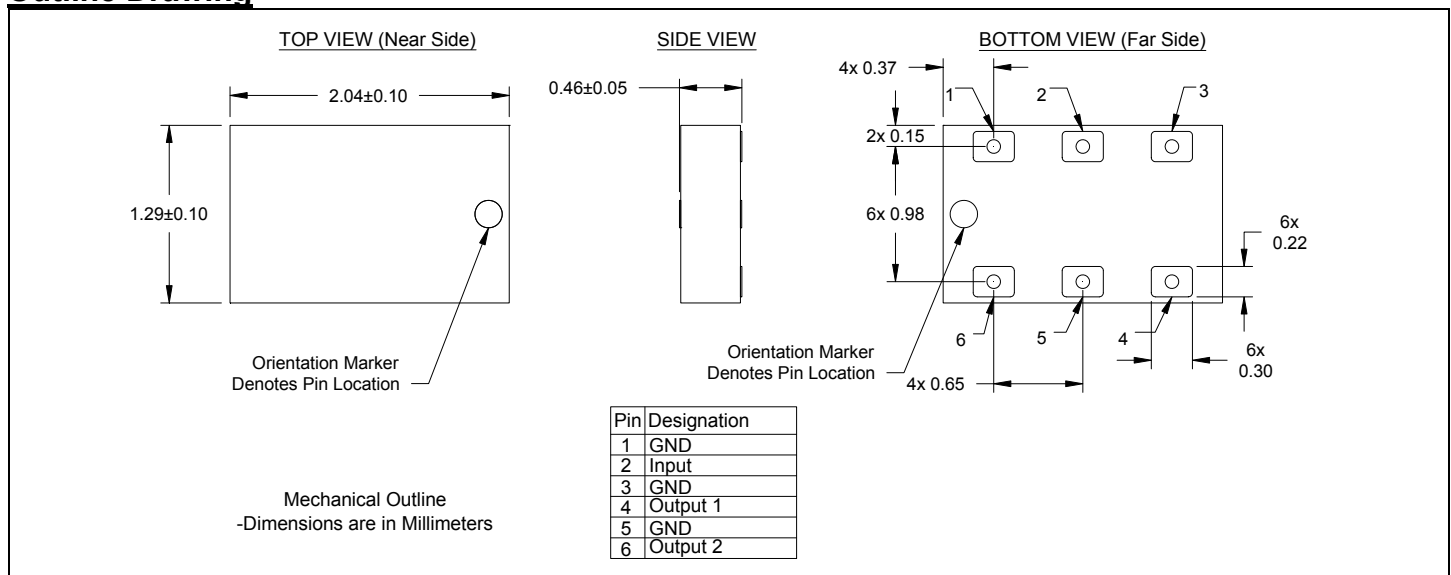

## Typical Broadband Performance: 500 MHz. to 8.0 GHz.

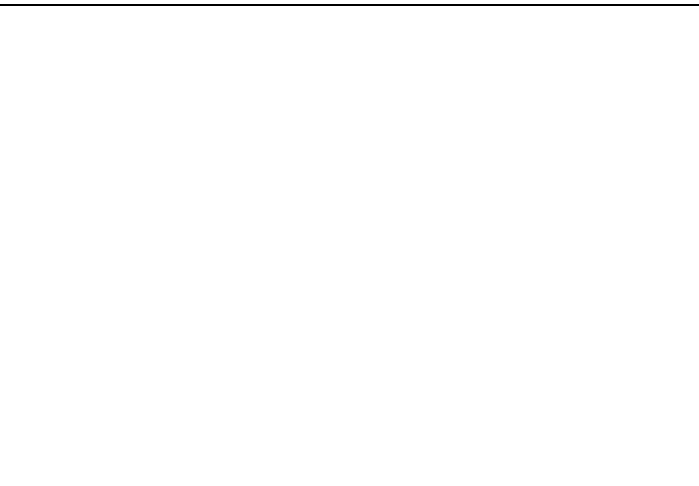
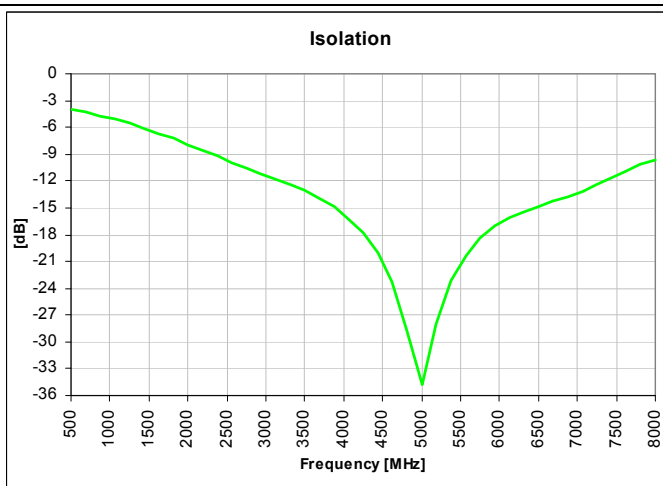
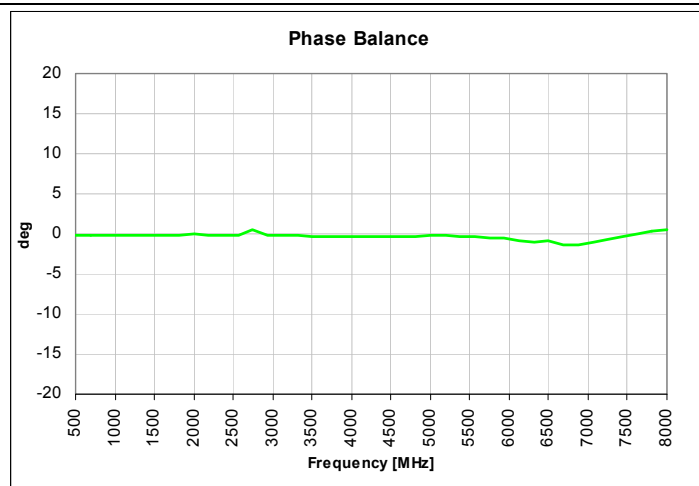
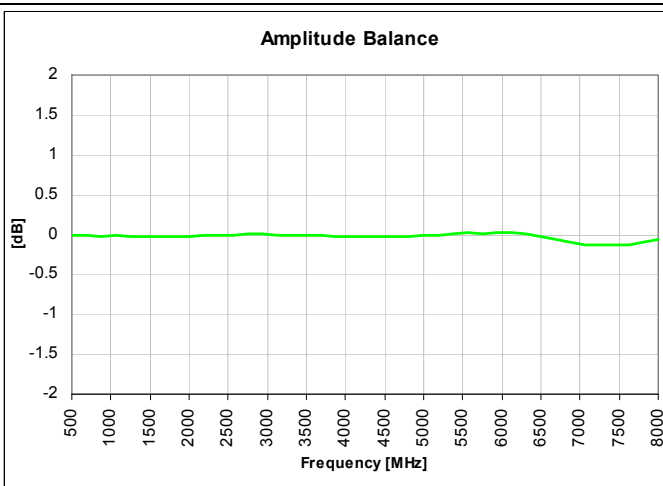
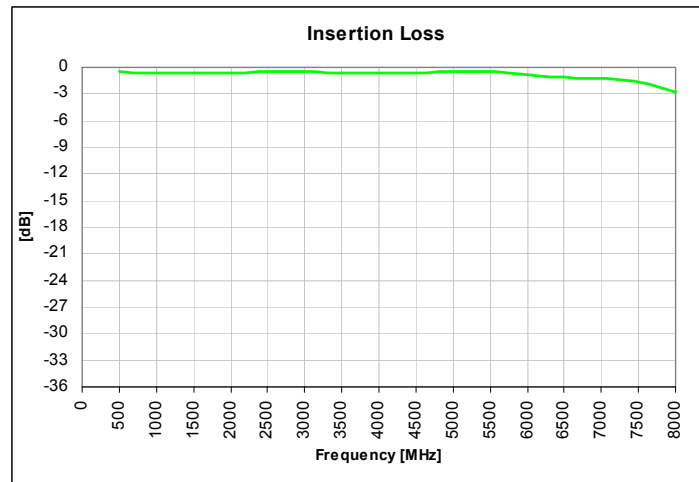
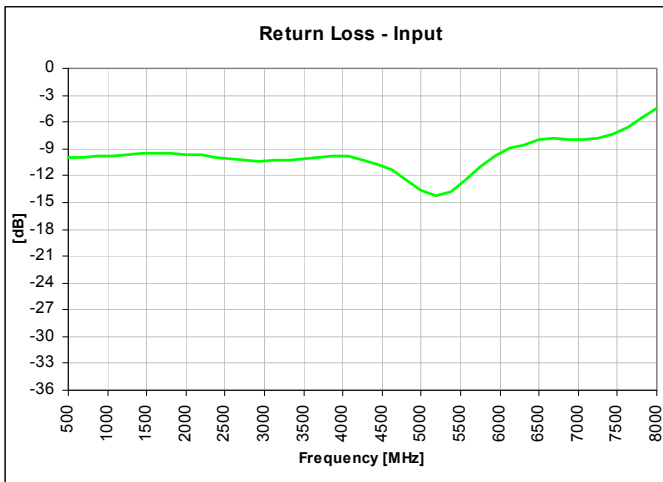

### Typical Performance: 4700 MHz. to 6000 MHz.

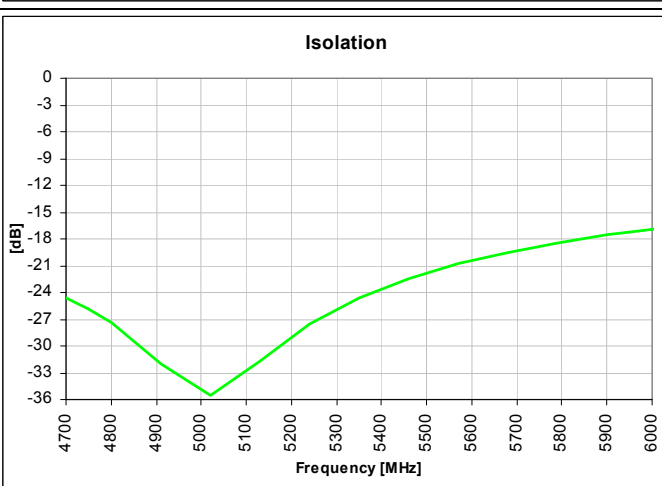
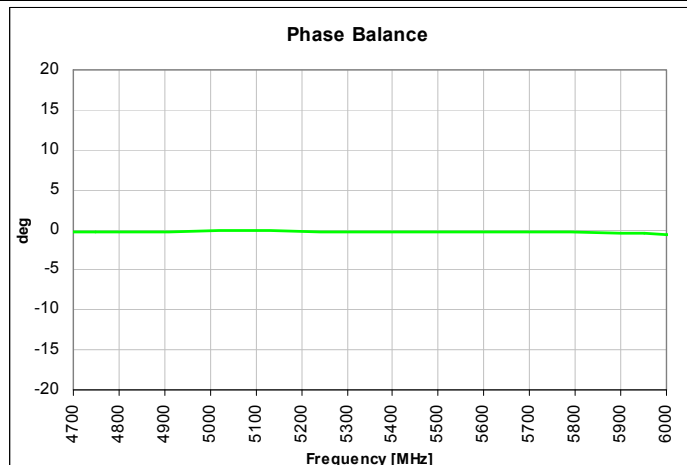
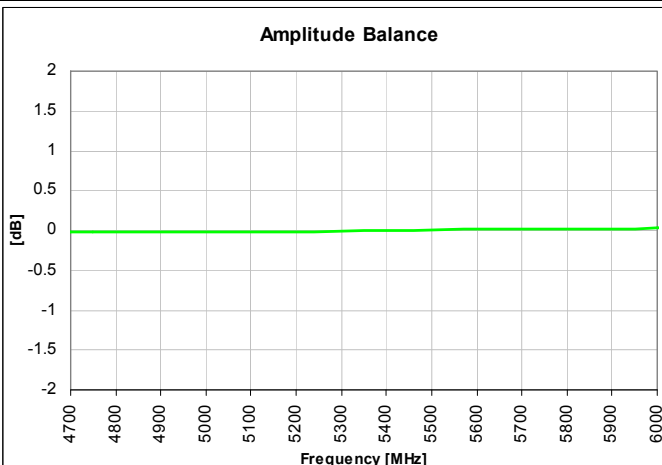
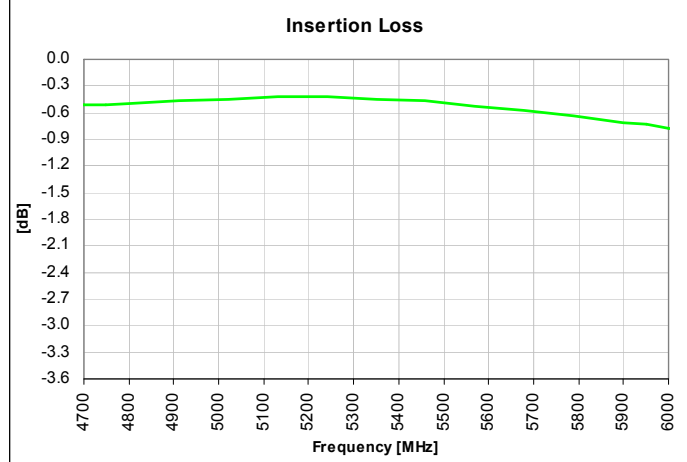
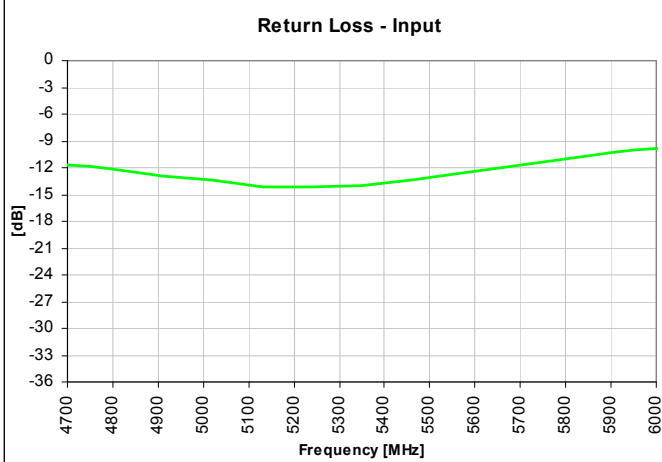

## Mounting Configuration:

In order for Xinger surface mount components to work optimally, the proper impedance transmission lines must be used to connect to the RF ports. If this condition is not satisfied, insertion loss, Isolation and VSWR may not meet published specifications.

An example of the PCB footprint used in the testing of these parts is shown below. In specific designs, the transmission line widths need to be adjusted to the unique dielectric coefficients and thicknesses as well as varying pick and place equipment tolerances. In addition, since the PD4859J5050S2HF is a Wilkinson power divider, an external 0603 100Ω resistor must be mounted in locations R1 as shown in the Figure below.

All of the Xinger components are constructed from ceramic filled PTFE composites which possess excellent electrical and mechanical stability having X and Y thermal coefficient of expansion (CTE) of 17 ppm/°C.

### Pad Footprint w/ 0603 Resistor Location

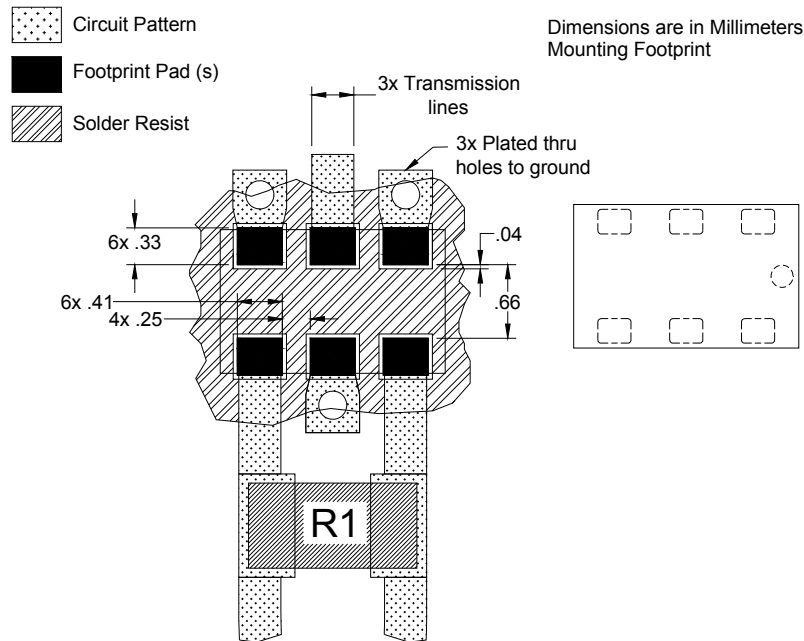

### Packaging and Ordering Information

Parts are available in reels and are packaged per EIA 481-2. Parts are oriented in tape and reel as shown below. Minimum order quantities are 4000 per reel.

