

PD600BA

N-Channel Enhancement Mode MOSFET

PRODUCT SUMMARY

$V_{(BR)DSS}$	$R_{DS(ON)}$	I_D
30V	9.5mΩ @ $V_{GS} = 10V$	42A

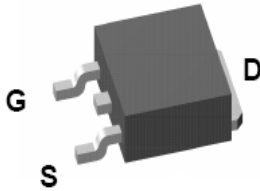

TO-252

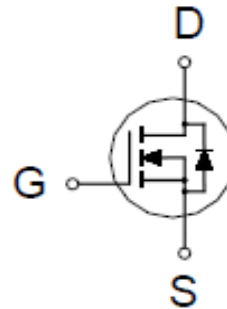

ABSOLUTE MAXIMUM RATINGS ($T_A = 25\text{ °C}$ Unless Otherwise Noted)

PARAMETERS/TEST CONDITIONS		SYMBOL	LIMITS	UNITS
Drain-Source Voltage		V_{DS}	30	V
Gate-Source Voltage		V_{GS}	±20	V
Continuous Drain Current ²	$T_C = 25\text{ °C}$	I_D	42	A
	$T_C = 100\text{ °C}$		26	
Pulsed Drain Current ¹		I_{DM}	120	
Avalanche Current		I_{AS}	20	
Avalanche Energy	$L=0.1\text{mH}$	E_{AS}	20	mJ
Power Dissipation	$T_C = 25\text{ °C}$	P_D	32	W
	$T_C = 100\text{ °C}$		13	
Junction & Storage Temperature Range		T_j, T_{stg}	-55 to 150	°C

THERMAL RESISTANCE RATINGS

THERMAL RESISTANCE	SYMBOL	TYPICAL	MAXIMUM	UNITS
Junction-to-Case	$R_{\theta JC}$		3.8	°C / W
Junction-to-Ambient	$R_{\theta JA}$		62.5	

¹Pulse width limited by maximum junction temperature.

²Package limitation current is 28A

PD600BA

N-Channel Enhancement Mode MOSFET

ELECTRICAL CHARACTERISTICS (T_J = 25 °C, Unless Otherwise Noted)

PARAMETER	SYMBOL	TEST CONDITIONS	LIMITS			UNITS
			MIN	TYP	MAX	
STATIC						
Drain-Source Breakdown Voltage	V _{(BR)DSS}	V _{GS} = 0V, I _D = 250μA	30			V
Gate Threshold Voltage	V _{GS(th)}	V _{DS} = V _{GS} , I _D = 250μA	1.3	1.8	2.3	V
Gate-Body Leakage	I _{GSS}	V _{DS} = 0V, V _{GS} = ±20V			±100	nA
Zero Gate Voltage Drain Current	I _{DSS}	V _{DS} = 24V, V _{GS} = 0V			1	μA
		V _{DS} = 20V, V _{GS} = 0V, T _J = 125°C			10	
Drain-Source On-State Resistance ¹	R _{DS(ON)}	V _{GS} = 4.5V, I _D = 15A		9.6	13.5	mΩ
		V _{GS} = 10V, I _D = 20A		7.3	9.5	
Forward Transconductance ¹	g _{fs}	V _{DS} = 5V, I _D = 20A		63		S
DYNAMIC						
Input Capacitance	C _{iss}	V _{GS} = 0V, V _{DS} = 15V, f = 1MHz		617		pF
Output Capacitance	C _{oss}			120		
Reverse Transfer Capacitance	C _{rss}			84		
Gate Resistance	R _g	V _{GS} = 0V, V _{DS} = 0V, f = 1MHz		2.5		Ω
Total Gate Charge ²	Q _g	V _{GS} = 10V, V _{DS} = 15V, I _D = 20A		14		nC
Gate-Source Charge ²	Q _{gs}			1.5		
Gate-Drain Charge ²	Q _{gd}			3.7		
Turn-On Delay Time ²	t _{d(on)}	V _{DS} = 15V, I _D ≅ 20A, V _{GS} = 10V, R _{GEN} = 6Ω		17		nS
Rise Time ²	t _r			41		
Turn-Off Delay Time ²	t _{d(off)}			55		
Fall Time ²	t _f			30		
SOURCE-DRAIN DIODE RATINGS AND CHARACTERISTICS (T_J = 25 °C)						
Continuous Current ³	I _S				29	A
Forward Voltage ¹	V _{SD}	I _F = 20A, V _{GS} = 0V			1.1	V
Reverse Recovery Time	t _{rr}	I _F = 20A, di _F /dt = 100A / μS		10		nS
Reverse Recovery Charge	Q _{rr}				3	

¹Pulse test : Pulse Width ≤ 300 μsec, Duty Cycle ≤ 2%.

²Independent of operating temperature.

³Package limitation current is 28A.

PD600BA

N-Channel Enhancement Mode MOSFET

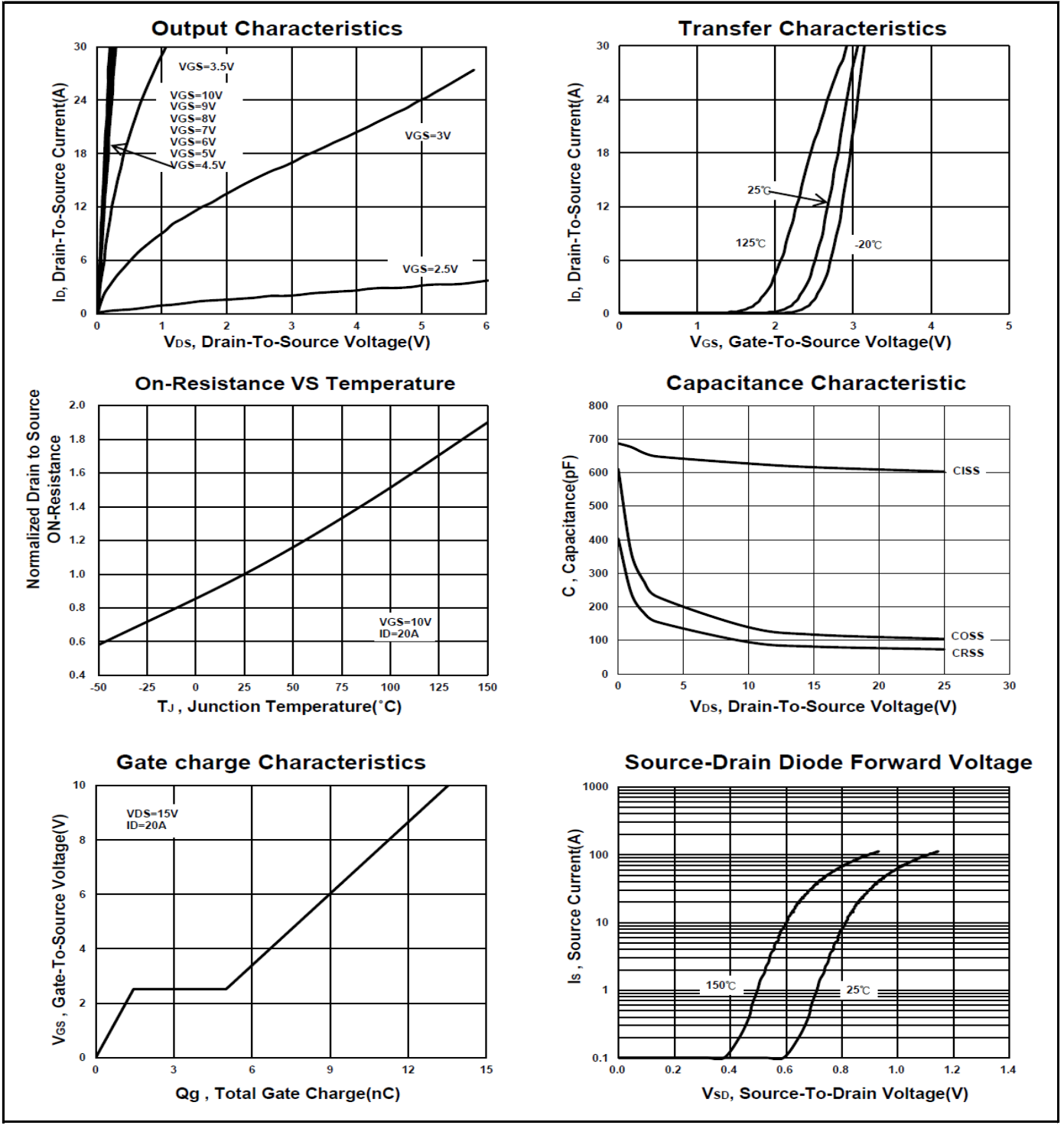

PD600BA

N-Channel Enhancement Mode MOSFET

Safe Operating Area

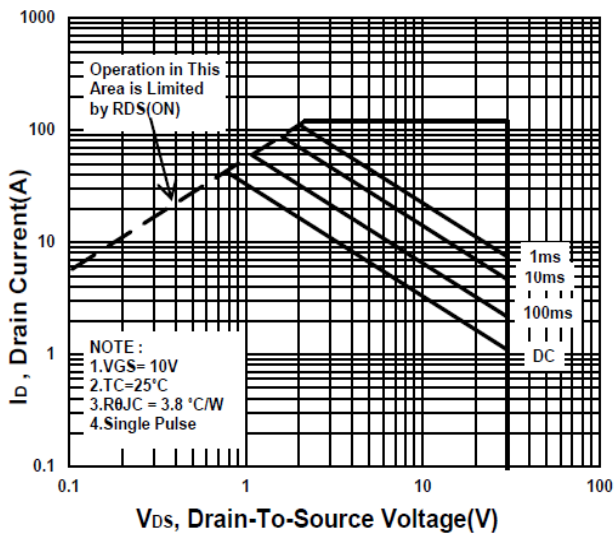

Single Pulse Maximum Power Dissipation

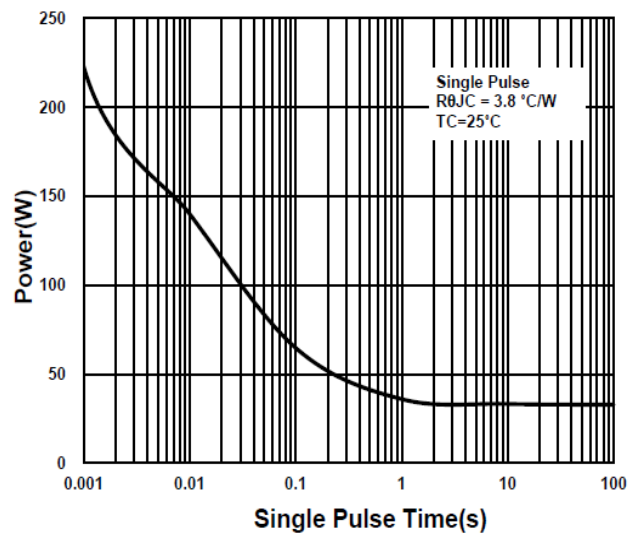

Transient Thermal Response Curve

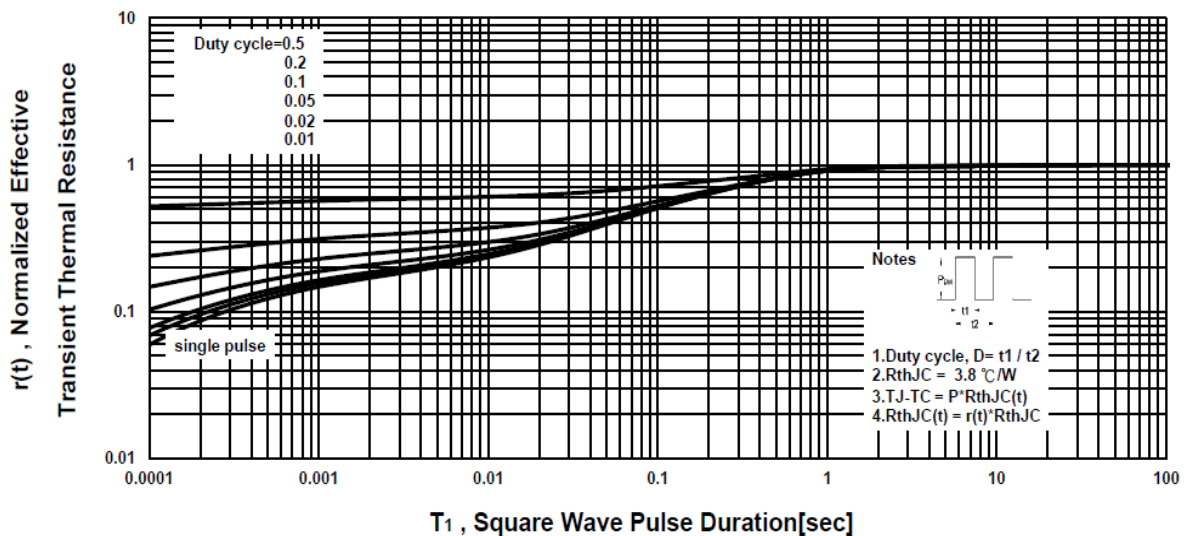

PD600BA

N-Channel Enhancement Mode MOSFET

Package Dimension

TO-252 (DPAK) MECHANICAL DATA

Dimension	mm			Dimension	mm		
	Min.	Typ.	Max.		Min.	Typ.	Max.
A	8.9	10	10.41	J	4.8		5.64
B	2.1	2.2	2.4	K	0.15		1.1
C	0.4	0.5	0.61	L	0.4	0.76	0.89
D	0.82	1.2	1.5	M	4.2	4.58	5
E	0.4	0.5	0.61	S	4.9	5.1	5.3
F	0		0.2	T	4.6	4.75	5.44
G	5.3	6.1	6.3	U	1.4		1.78
H	0.9		1.7	V	0.55	1.25	1.7
I	6.3	6.5	6.8				

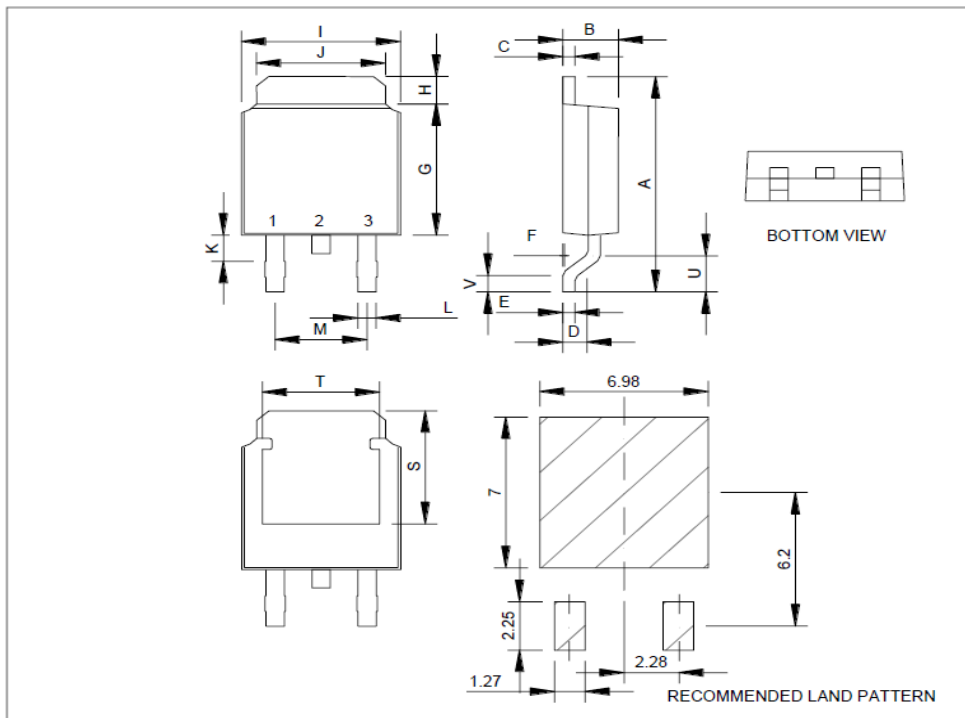

*因为各家封装模具不同而外观略有所差异，不影响电性及Layout。

PD600BA

N-Channel Enhancement Mode MOSFET

A. Marking Information

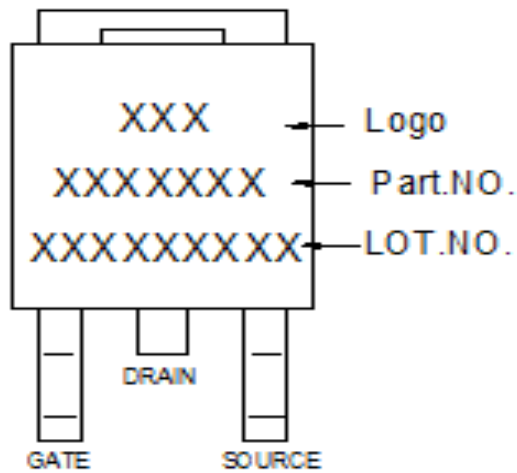

B. Tape & Reel Information: 2500pcs/Reel

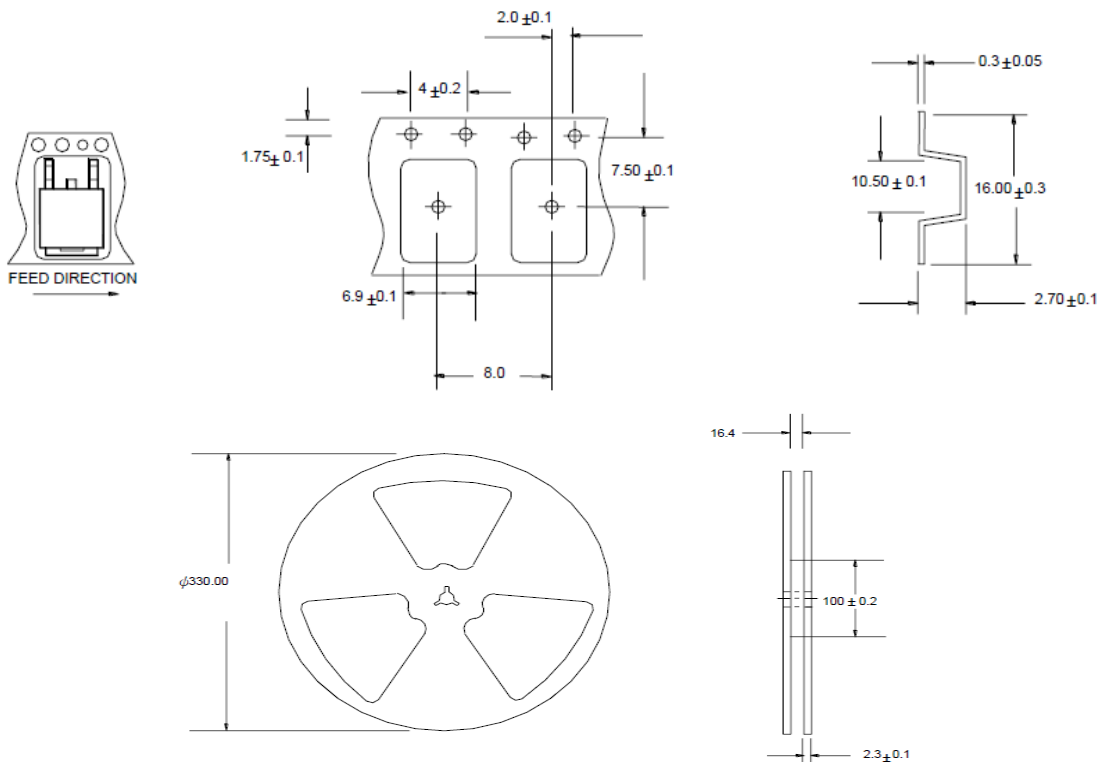

PD600BA

N-Channel Enhancement Mode MOSFET

C. Lot.No. & Date Code rule

1.LOT.NO.

M N 15M21 03

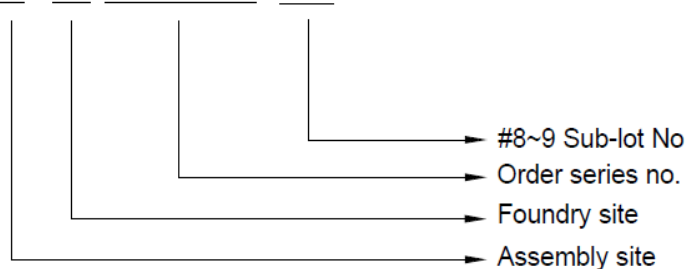

2.Date Code

D Y M X XXX

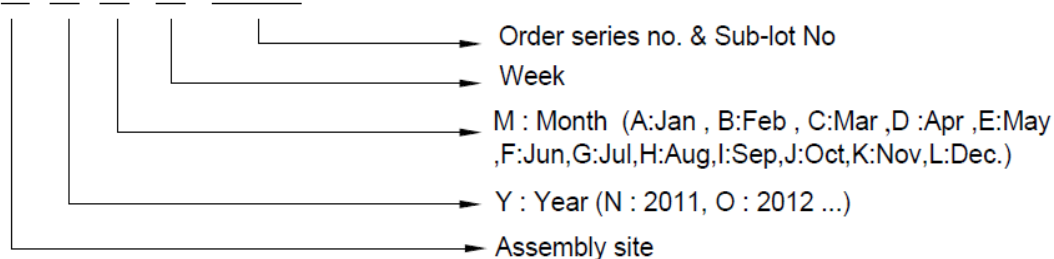

3.Date Code (for Small package)

XX Y WW

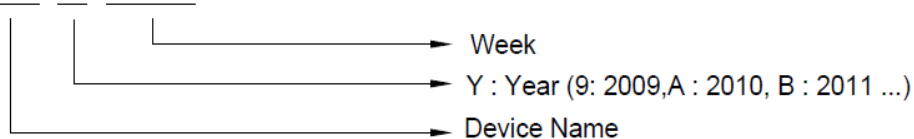



PD600BA

N-Channel Enhancement Mode MOSFET

D.Label rule

标签内容(Label content)



1	Label Size	30 * 90 mm
2	Font style	Times New Roman or Arial (或可区分英文"0"和数字"0", "G和"Q"的字型即可)
3	Great Power	Height: 4 mm
4	Package	Height: 2 mm
5	Date	Height: 2 mm Shipping date: YYYY/MM/DD, ex. 2008/09/12
6	Device	Height: 3 mm (Max: 16 Digit)
7	Lot	Height: 3 mm (Max: 9 Digit) Sub lot
8	D/C	Height: 3 mm (Max: 7 Digit)
9	QTY	Height: 3 mm (Max: 6 Digit) Thousand mark is no needed
10	Pb Free label	 Diameter: 1 cm bottom color: Green Font color: Black Font style: Arial
11	Halogen Free label	 Diameter: 1 cm bottom color: Green Font color: Black Font style: Arial
12	Scan info	Device / Lot / D/C / QTY , Insert " / " between every parts. for example: P3055LDG/G12345601/GGG2301/2000 DPI (Dots per inch): Over 300 dpi Code : Code 128 Height: 6 mm at least