

# PD618BA

## N-Channel Enhancement Mode MOSFET

### PRODUCT SUMMARY

$V_{(BR)DSS}$	$R_{DS(ON)}$	$I_D$
30V	5.5m $\Omega$ @ $V_{GS} = 10V$	74A

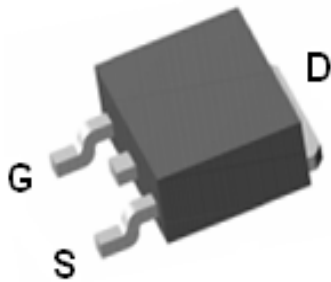

TO-252

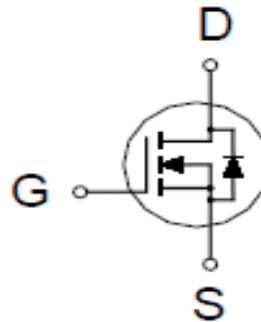

### ABSOLUTE MAXIMUM RATINGS ( $T_A = 25\text{ }^\circ\text{C}$ Unless Otherwise Noted)

PARAMETERS/TEST CONDITIONS	SYMBOL	LIMITS	UNITS
Drain-Source Voltage	$V_{DS}$	30	V
Gate-Source Voltage	$V_{GS}$	$\pm 20$	
Continuous Drain Current <sup>2</sup>	$I_D$	$T_C = 25\text{ }^\circ\text{C}$	74
		$T_C = 100\text{ }^\circ\text{C}$	46
Pulsed Drain Current <sup>1</sup>	$I_{DM}$	150	A
Avalanche Current	$I_{AS}$	31	
Avalanche Energy	$E_{AS}$	48	mJ
Power Dissipation	$P_D$	$T_C = 25\text{ }^\circ\text{C}$	54
		$T_C = 100\text{ }^\circ\text{C}$	21
Junction & Storage Temperature Range	$T_j, T_{stg}$	-55 to 150	$^\circ\text{C}$

### THERMAL RESISTANCE RATINGS

THERMAL RESISTANCE	SYMBOL	TYPICAL	MAXIMUM	UNITS
Junction-to-Ambient	$R_{\theta JA}$		62.5	$^\circ\text{C} / \text{W}$
Junction-to-Case	$R_{\theta JC}$		2.3	

<sup>1</sup>Pulse width limited by maximum junction temperature.

<sup>2</sup>Package limitation current is 40A.

## PD618BA

### N-Channel Enhancement Mode MOSFET

#### ELECTRICAL CHARACTERISTICS (T<sub>J</sub> = 25 °C, Unless Otherwise Noted)

PARAMETER	SYMBOL	TEST CONDITIONS	LIMITS			UNITS
			MIN	TYP	MAX	
<b>STATIC</b>						
Drain-Source Breakdown Voltage	V <sub>(BR)DSS</sub>	V <sub>GS</sub> = 0V, I <sub>D</sub> = 250μA	30			V
Gate Threshold Voltage	V <sub>GS(th)</sub>	V <sub>DS</sub> = V <sub>GS</sub> , I <sub>D</sub> = 250μA	1.3	1.7	2.3	
Gate-Body Leakage	I <sub>GSS</sub>	V <sub>DS</sub> = 0V, V <sub>GS</sub> = ±20V			±100	nA
Zero Gate Voltage Drain Current	I <sub>DSS</sub>	V <sub>DS</sub> = 24V, V <sub>GS</sub> = 0V			1	μA
		V <sub>DS</sub> = 20V, V <sub>GS</sub> = 0V, T <sub>J</sub> = 125 °C			10	
Drain-Source On-State Resistance <sup>1</sup>	R <sub>DS(ON)</sub>	V <sub>GS</sub> = 4.5V, I <sub>D</sub> = 15A		4.3	8	mΩ
		V <sub>GS</sub> = 10V, I <sub>D</sub> = 20A		3.3	5.5	
Forward Transconductance <sup>1</sup>	g <sub>fs</sub>	V <sub>DS</sub> = 5V, I <sub>D</sub> = 20A		60		S
<b>DYNAMIC</b>						
Input Capacitance	C <sub>iss</sub>	V <sub>GS</sub> = 0V, V <sub>DS</sub> = 15V, f = 1MHz		1435		pF
Output Capacitance	C <sub>oss</sub>			259		
Reverse Transfer Capacitance	C <sub>rss</sub>			162		
Gate Resistance	R <sub>g</sub>	V <sub>GS</sub> = 0V, V <sub>DS</sub> = 0V, f = 1MHz		1.3		Ω
Total Gate Charge <sup>2</sup>	Q <sub>g(VGS=10V)</sub>	V <sub>DS</sub> = 15V, I <sub>D</sub> = 20A		28.3		nC
	Q <sub>g(VGS=4.5V)</sub>			15.4		
Gate-Source Charge <sup>2</sup>	Q <sub>gs</sub>			3.5		
Gate-Drain Charge <sup>2</sup>	Q <sub>gd</sub>			7.7		
Turn-On Delay Time <sup>2</sup>	t <sub>d(on)</sub>		V <sub>DS</sub> = 15V, I <sub>D</sub> ≅ 20A, V <sub>GS</sub> = 10V, R <sub>GEN</sub> = 6Ω		35	
Rise Time <sup>2</sup>	t <sub>r</sub>			25		
Turn-Off Delay Time <sup>2</sup>	t <sub>d(off)</sub>			70		
Fall Time <sup>2</sup>	t <sub>f</sub>			25		
<b>SOURCE-DRAIN DIODE RATINGS AND CHARACTERISTICS (T<sub>J</sub> = 25 °C)</b>						
Continuous Current <sup>3</sup>	I <sub>S</sub>				45	A
Forward Voltage <sup>1</sup>	V <sub>SD</sub>	I <sub>F</sub> = 20A, V <sub>GS</sub> = 0V			1.2	V
Reverse Recovery Time	t <sub>rr</sub>	I <sub>F</sub> = 20A, di <sub>F</sub> /dt = 100A / μS		24		nS
Reverse Recovery Charge	Q <sub>rr</sub>			11		nC

<sup>1</sup>Pulse test : Pulse Width ≤ 300 μsec, Duty Cycle ≤ 2%.

<sup>2</sup>Independent of operating temperature.

<sup>3</sup>Package limitation current is 40A.

# PD618BA

## N-Channel Enhancement Mode MOSFET

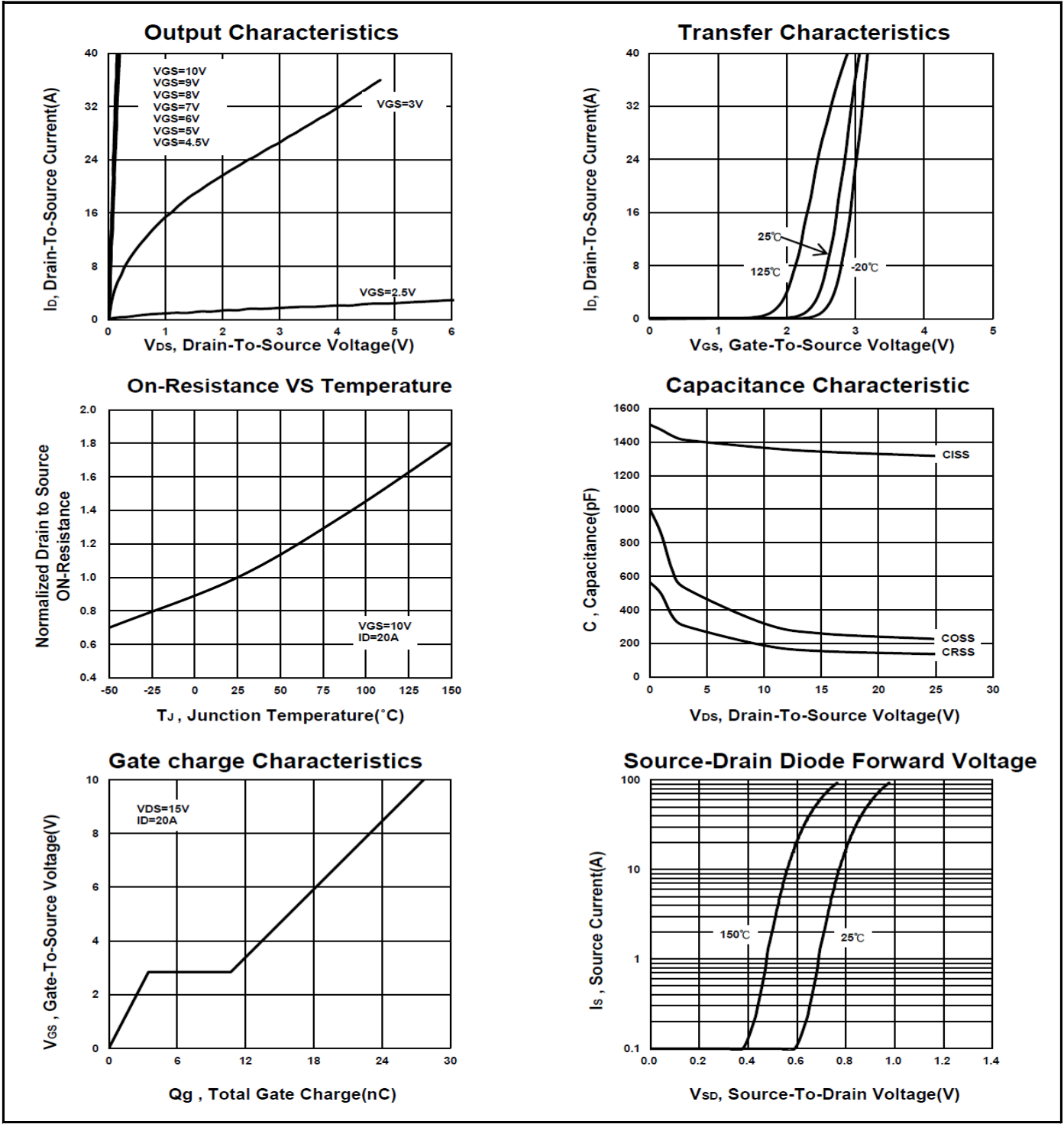

# PD618BA

## N-Channel Enhancement Mode MOSFET

**Safe Operating Area**

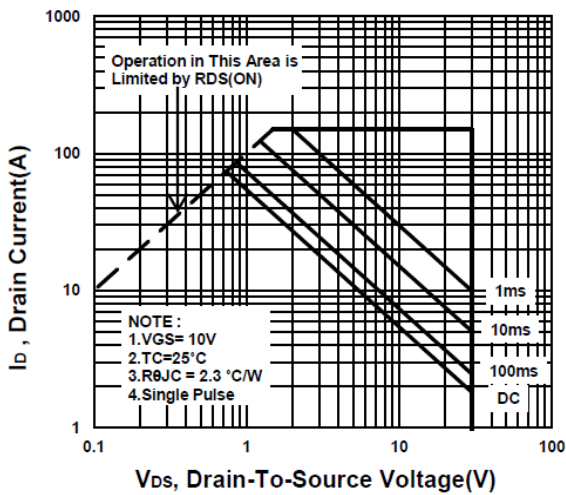

**Single Pulse Maximum Power Dissipation**

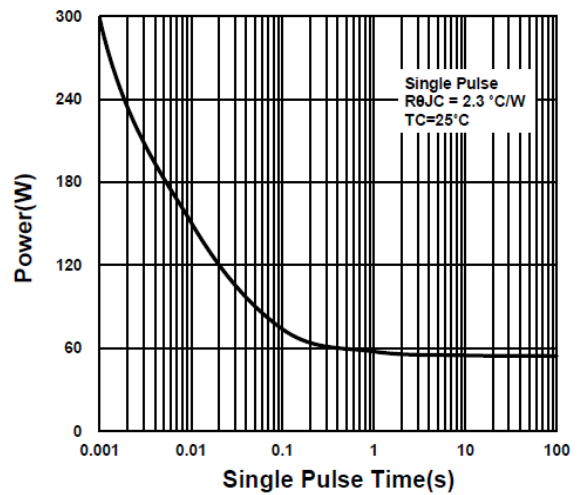

**Transient Thermal Response Curve**

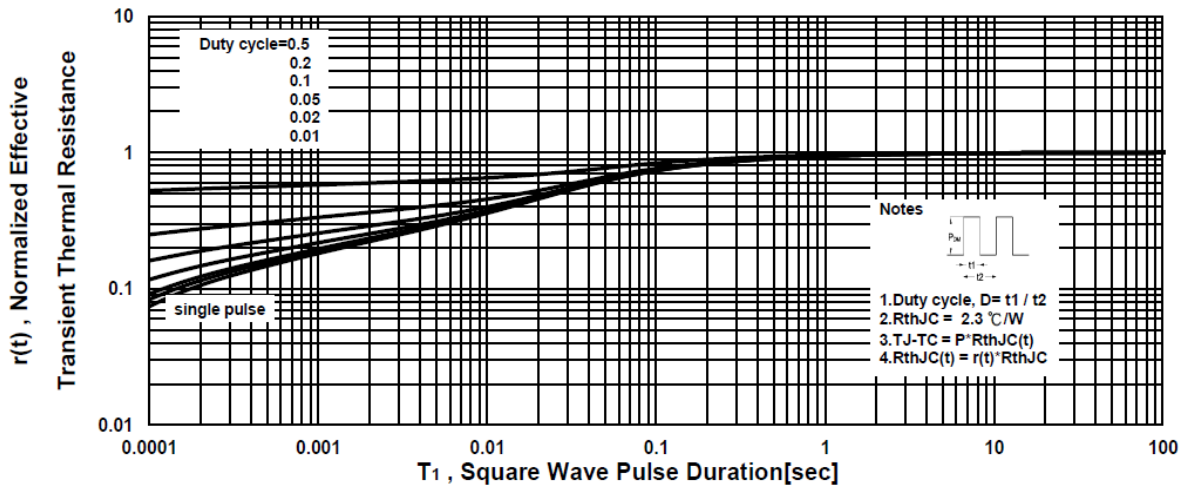

# PD618BA

## N-Channel Enhancement Mode MOSFET

### Package Dimension

### TO-252 (DPAK) MECHANICAL DATA

Dimension	mm			Dimension	mm		
	Min.	Typ.	Max.		Min.	Typ.	Max.
A	8.9	10	10.41	J	4.8		5.64
B	2.1	2.2	2.4	K	0.15		1.1
C	0.4	0.5	0.61	L	0.4	0.76	0.89
D	0.82	1.2	1.5	M	4.2	4.58	5
E	0.4	0.5	0.61	S	4.9	5.1	5.3
F	0		0.2	T	4.6	4.75	5.44
G	5.3	6.1	6.3	U	1.4		1.78
H	0.9		1.7	V	0.55	1.25	1.7
I	6.3	6.5	6.8				

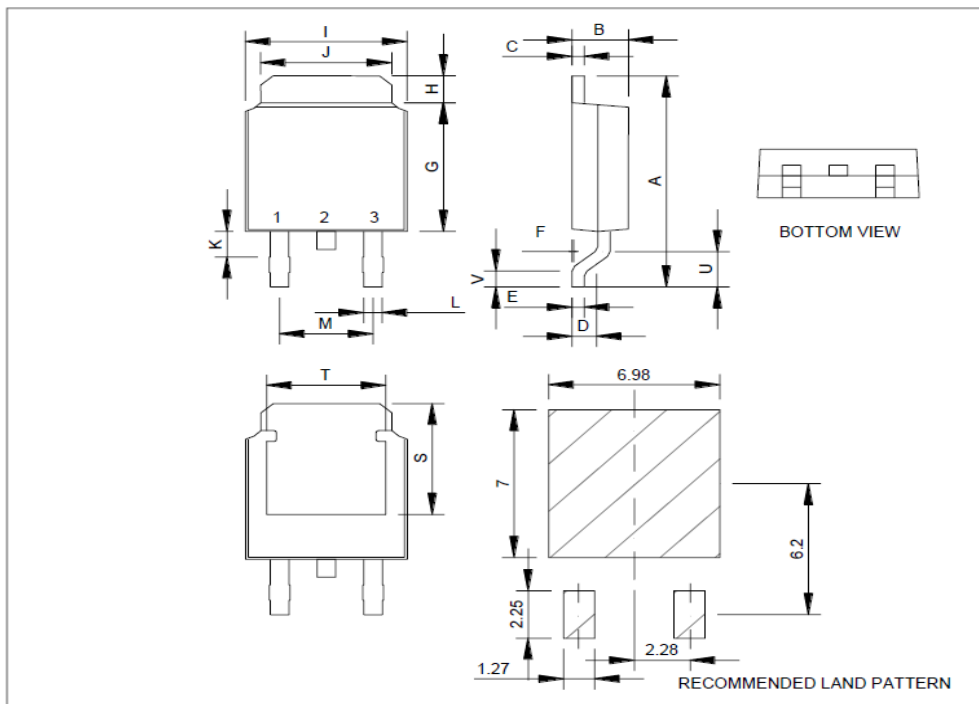

\*因为各家封装厂模具不同而外观略有所差异，不影响电性及Layout。

# PD618BA

## N-Channel Enhancement Mode MOSFET

### A. Marking Information

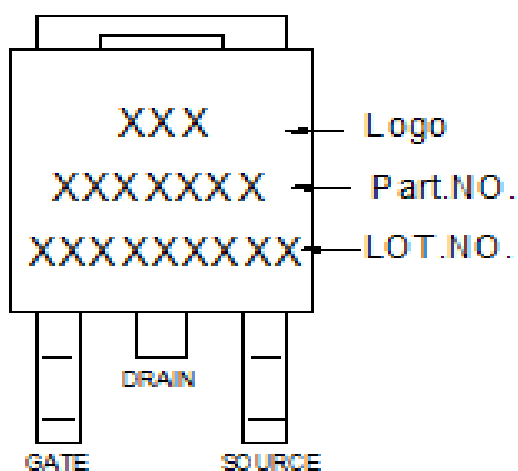

### B. Tape&Reel Information:2500pcs/Reel

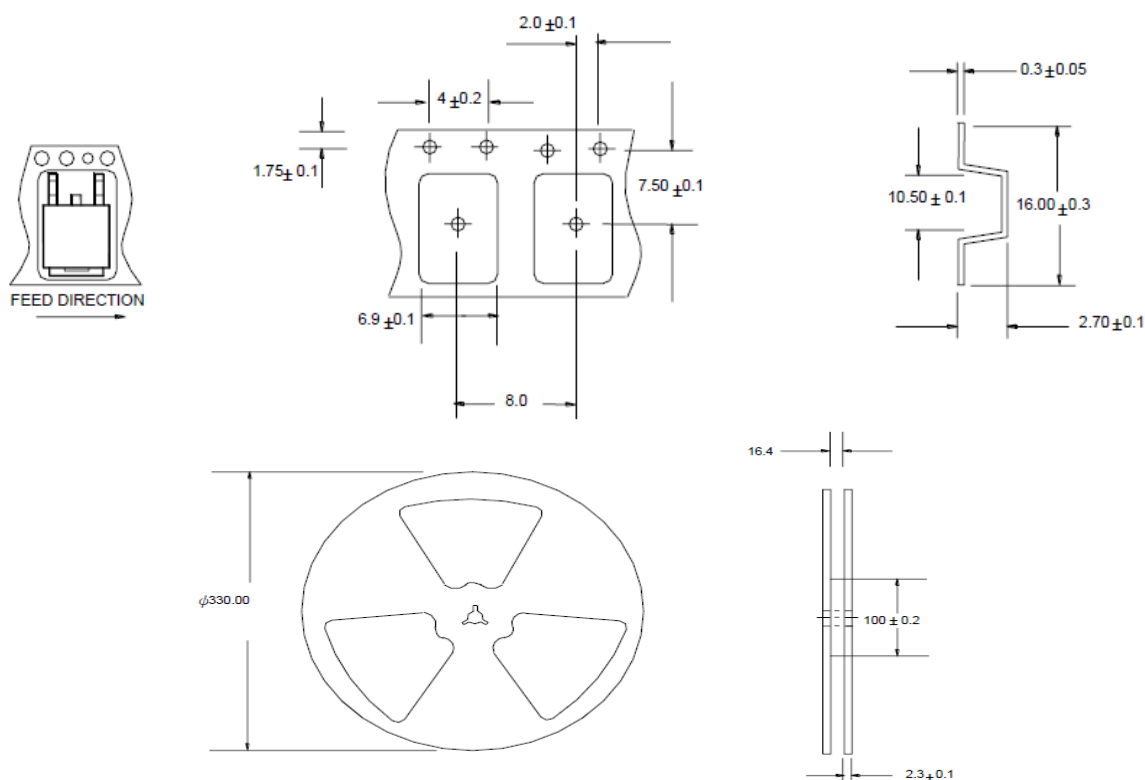

**PD618BA**  
**N-Channel Enhancement Mode MOSFET**

**C. Lot No.&Date Code rule**

1.Lot No.

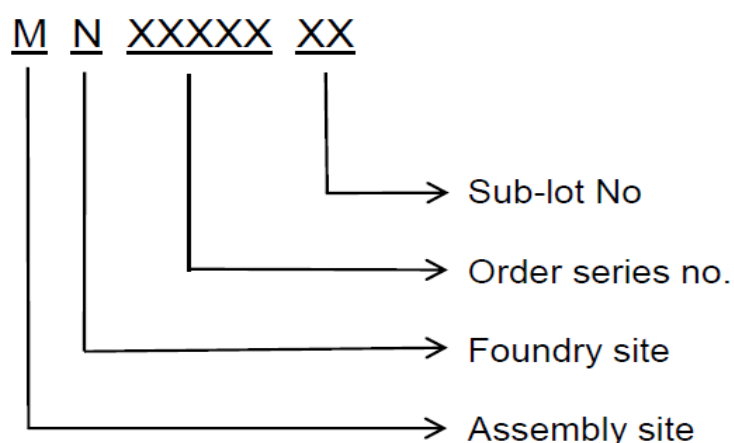

2.Date Code

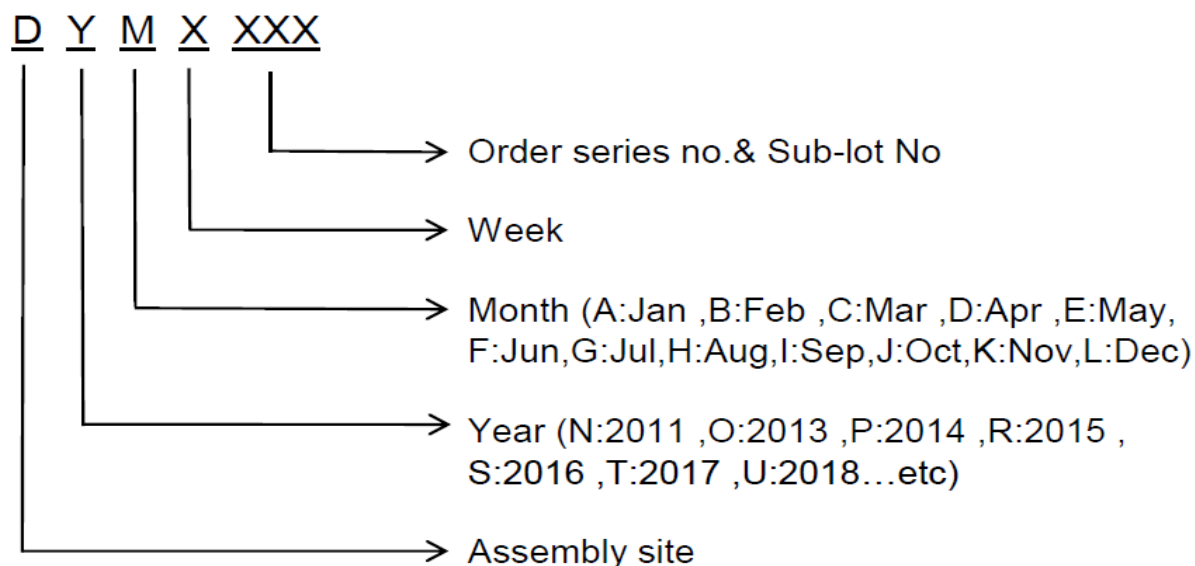



## PD618BA

### N-Channel Enhancement Mode MOSFET

#### D.Label rule

标签内容(Label content)



1	Label Size	30 * 90 mm
2	Font style	Times New Roman or Arial (或可区分英文"0"和数字"0", "G"和"Q"的字型即可)
3	Great Power	Height: 4 mm
4	Package	Height: 2 mm
5	Date	Height: 2 mm Shipping date: YYYY/MM/DD, ex. 2008/09/12
6	Device	Height: 3 mm (Max: 16 Digit)
7	Lot	Height: 3 mm (Max: 9 Digit) Sub lot
8	D/C	Height: 3 mm (Max: 7 Digit)
9	QTY	Height: 3 mm (Max: 6 Digit) Thousand mark is no needed
10	Pb Free label	 Diameter: 1 cm bottom color: Green Font color: Black Font style: Arial
11	Halogen Free label	 Diameter: 1 cm bottom color: Green Font color: Black Font style: Arial
12	Scan info	Device / Lot / D/C / QTY , Insert " / " between every parts. for example: P3055LDG/G12345601/GGG2301/2000 DPI (Dots per inch): Over 300 dpi Code : Code 128 Height: 6 mm at least