

IGBT Module-Dual

50 A, 1200V

PDMB50B12

□ 回路図 : CIRCUIT

□ 外形寸法図 : OUTLINE DRAWING

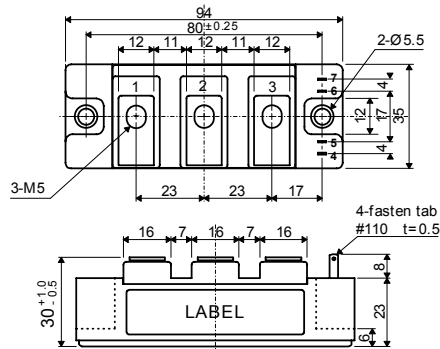
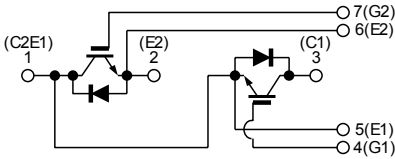

Dimension: [mm]

□ 最大定格 : MAXIMUM RATINGS (T_c=25°C)

Item	Symbol	Rated Value	Unit
コレクタ・エミッタ間電圧 Collector-Emitter Voltage	V _{CEs}	1,200	V
ゲート・エミッタ間電圧 Gate-Emitter Voltage	V _{GES}	±20	V
コレクタ電流 Collector Current	DC	I _c = 50	A
	1ms	I _{CP} = 100	
コレクタ損失 Collector Power Dissipation	P _c	250	W
接合温度 Junction Temperature Range	T _j	-40~+150	°C
保存温度 Storage Temperature Range	T _{stg}	-40~+125	°C
絶縁耐圧(Terminal to Base AC, 1 minute) Isolation Voltage	V _{iso}	2,500	V _(RMS)
締め付けトルク Mounting Torque	Module Base to Heatsink	2 (20.4)	N·m (kgf·cm)
	Busbar to Main Terminal		

□ 電気的特性 : ELECTRICAL CHARACTERISTICS (T_c=25°C)

Characteristic	Symbol	Test Condition	Min.	Tvp.	Max.	Unit
コレクタ遮断電流 Collector-Emitter Cut-Off Current	I _{CEs}	V _{CE} =1200V, V _{GE} =0V	-	-	1.0	mA
ゲート漏れ電流 Gate-Emitter Leakage Current	I _{GES}	V _{GE} =±20V, V _{CE} =0V	-	-	1.0	μA
コレクタ・エミッタ間飽和電圧 Collector-Emitter Saturation Voltage	V _{CE(sat)}	I _c =50A, V _{GE} =15V	-	1.9	2.4	V
ゲートしきい値電圧 Gate-Emitter Threshold Voltage	V _{GE(th)}	V _{CE} =5V, I _c =50mA	4.0	-	8.0	V
入力容量 Input Capacitance	C _{ies}	V _{CE} =10V, V _{GE} =0V, f=1MHz	-	4,200	-	pF
スイッチング時間 Switching Time	上昇時間 Rise Time	V _{CC} =600V R _L =12Ω R _G =20Ω V _{GE} =±15V	-	0.25	0.45	μs
	ターンオン時間 Turn-on Time		-	0.40	0.70	
	下降時間 Fall Time		-	0.25	0.35	
	ターンオフ時間 Turn-off Time		-	0.80	1.10	

□ フリーホイールリングダイオードの特性 : FREE WHEELING DIODE RATINGS & CHARACTERISTICS (T_c=25°C)

Item	Symbol	Rated Value	Unit			
順電流 Forward Current	DC	I _F = 50	A			
	1ms	I _{FM} = 100				
Characteristic	Symbol	Test Condition	Min.	Tvp.	Max.	Unit
順電圧 Peak Forward Voltage	V _F	I _F =50A, V _{GE} =0V	-	1.9	2.4	V
逆回復時間 Reverse Recovery Time	t _{rr}	I _F =50A, V _{GE} =-10V di/dt=100A/μs	-	0.2	0.3	μs

□ 熱的特性 : THERMAL CHARACTERISTICS

Characteristic	Symbol	Test Condition	Min.	Tvp.	Max.	Unit
熱抵抗 Thermal Impedance	IGBT	Junction to Case	-	-	0.43	°C/W
	Diode		-	-	0.7	

P D M B 5 0 B 1 2

Fig.1- Output Characteristics (Typical)

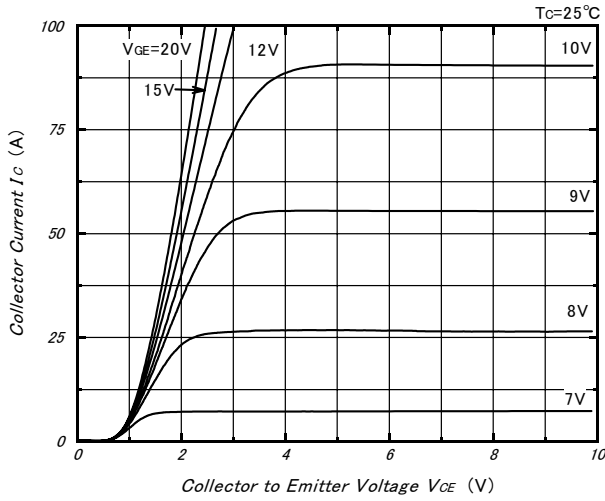

Fig.2- Collector to Emitter On Voltage vs. Gate to Emitter Voltage (Typical)

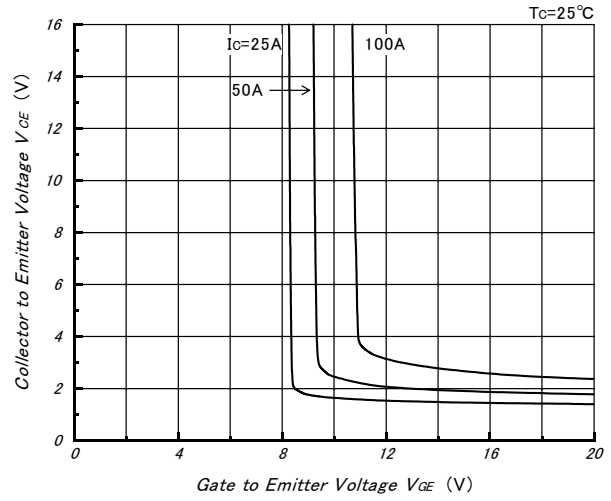

Fig.3- Collector to Emitter On Voltage vs. Gate to Emitter Voltage (Typical)

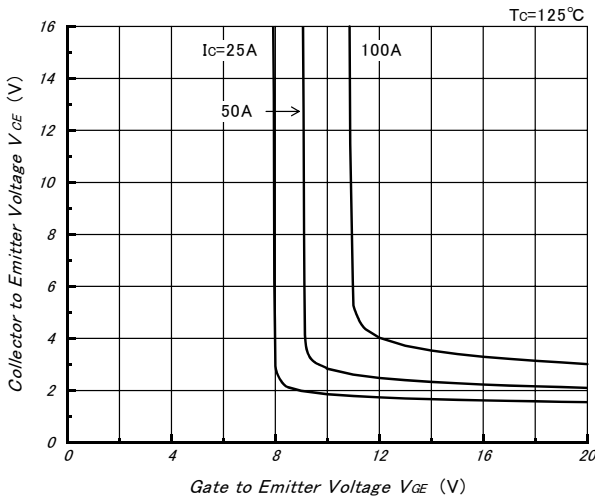

Fig.4- Gate Charge vs. Collector to Emitter Voltage (Typical)

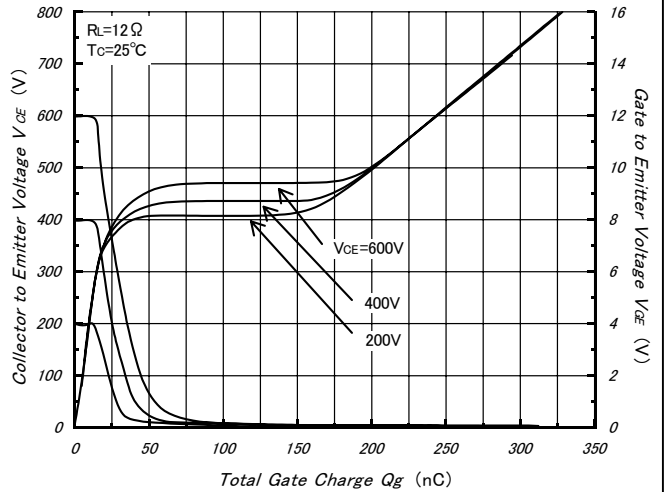

Fig.5- Capacitance vs. Collector to Emitter Voltage (Typical)

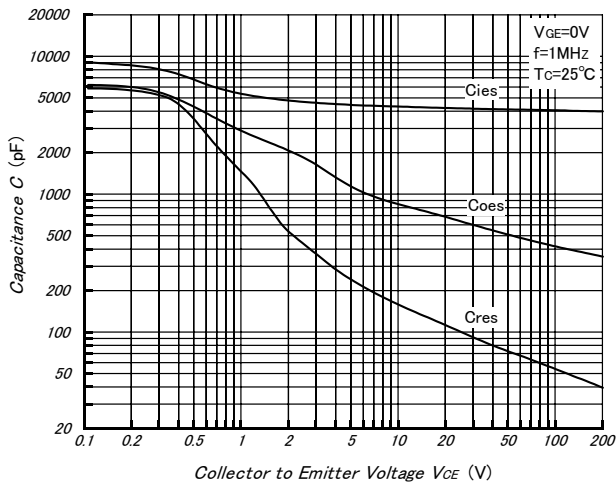
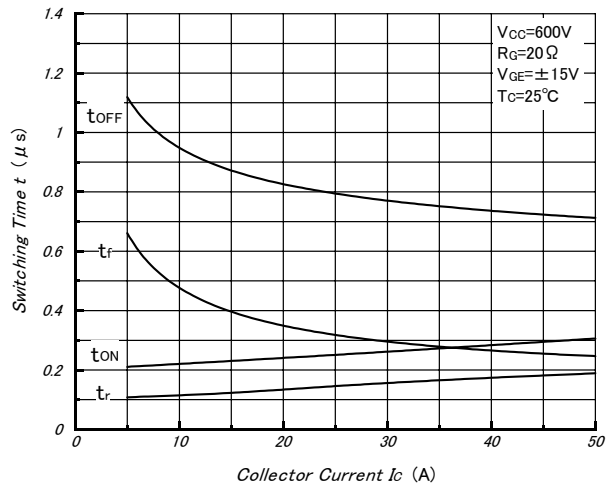

Fig.6- Collector Current vs. Switching Time (Typical)



P D M B 5 0 B 1 2

Fig.7- Series Gate Impedance vs. Switching Time (Typical)

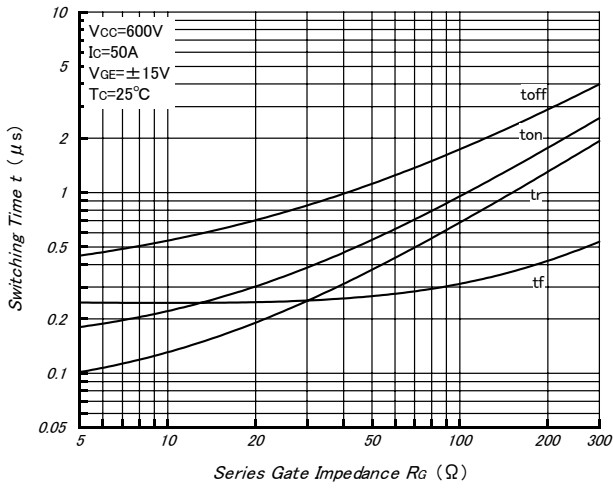

Fig.8- Forward Characteristics of Free Wheeling Diode (Typical)

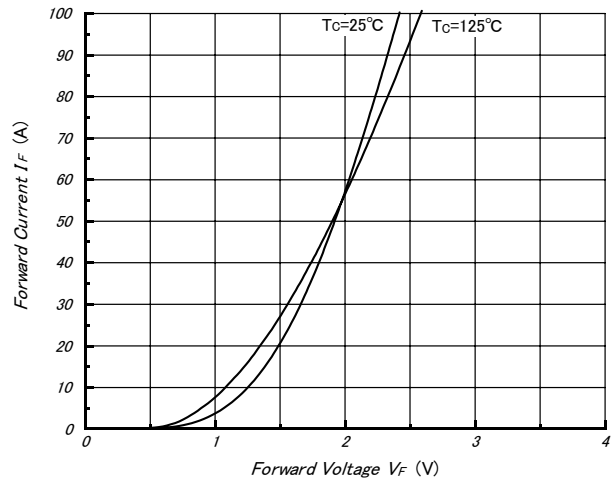

Fig.9- Reverse Recovery Characteristics (Typical)

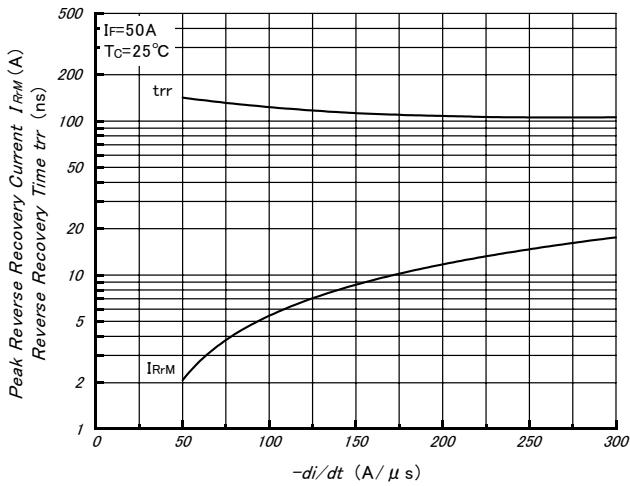

Fig.10- Reverse Bias Safe Operating Area

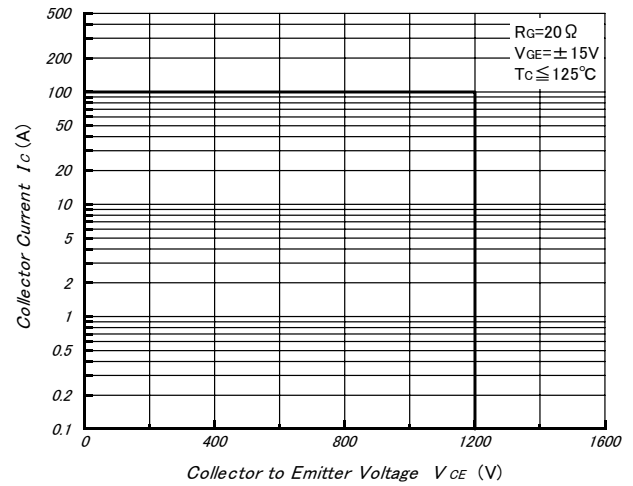

fig11-Tansient Thermal Impedance

