



3 Section Tunable Band Reject Filter With N Female Connectors Operating From 250 MHz to 500 MHz With a 1% Bandwidth

TECHNICAL DATA SHEET

PE8736

3 Section Tunable Band Reject Filter With N Female Connectors Operating From 250 MHz to 500 MHz With a 1% Bandwidth

Pasternack's Tunable Band Pass Filters and Band Reject Filters (also referred to as Band-Stop filters or Band-Rejection filters) are available in tunable frequency ranges from 100 MHz to 3 GHz. Tunable RF filter products are bench top units that are ideal for reducing harmonics and noise levels with lab-grade precision. The average power rating of these tunable filter components is 50 Watts and have a dial accuracy of 1%. Both the 3 section and 5 section bandpass and band-reject filters have a nominal 5% bandwidth that is tunable across the filter's frequency range.

- Available in both Band pass and Band reject
- 100 MHz to 3 GHz Frequency Ranges
- Typical VSWR is 1.5:1
- N-Type Connectors

Configuration

Design	Tunable Filter
Connector 1	N Female
Connector 2	N Female

Electrical Specifications

Useable Frequency Range, MHz	250 to 500
Bandwidth, MHz	3 to 7
Nominal Bandwidth, %	1
40 dB Minimum Bandwidth, KHz	300
Notch Depth, dB	50
Tuning Dial Accuracy, %	0.5
Maximum VSWR	1.5:1
Impedance, Ohms	50
Maximum Input Power, Watts	50

Mechanical Specifications

Temperature

Operating Range, deg C	-55 to +85
Storage Range, deg C	-55 to +125

Size

Length, in [mm]	6.4 [162.56]
Width, in [mm]	2.75 [69.85]
Height, in [mm]	5.3 [134.62]

Connector 1

Type	N Female
------	----------

Click the following link (or enter part number in "SEARCH" on website) to obtain additional part information including price, inventory and certifications: [3 Section Tunable Band Reject Filter With N Female Connectors Operating From 250 MHz to 500 MHz With a 1% Bandwidth PE8736](#)

The information contained in this document is accurate to the best of our knowledge and representative of the part described herein. It may be necessary to make modifications to the part and/or the documentation of the part, in order to implement improvements. Pasternack reserves the right to make such changes as required. Unless otherwise stated, all specifications are nominal.





3 Section Tunable Band Reject Filter With N Female Connectors
Operating From 250 MHz to 500 MHz With a 1% Bandwidth

TECHNICAL DATA SHEET

PE8736

Connector 2
Type

N Female

Compliance Certifications (visit www.Pasternack.com for current document)
RoHS Compliant

Yes

Plotted and Other Data

Notes:

Values at 25 °C, sea level

3 Section Tunable Band Reject Filter With N Female Connectors Operating From 250 MHz to 500 MHz With a 1% Bandwidth from Pasternack Enterprises has same day shipment for domestic and International orders. Our RF, microwave and fiber optic products maintain a 99% availability and are part of the broadest selection in the industry.

Click the following link (or enter part number in "SEARCH" on website) to obtain additional part information including price, inventory and certifications: [3 Section Tunable Band Reject Filter With N Female Connectors Operating From 250 MHz to 500 MHz With a 1% Bandwidth PE8736](http://www.pasternack.com/3-section-tunable-band-reject-filter-250-500-mhz-pe8736-p.aspx)

URL: <http://www.pasternack.com/3-section-tunable-band-reject-filter-250-500-mhz-pe8736-p.aspx>

The information contained in this document is accurate to the best of our knowledge and representative of the part described herein. It may be necessary to make modifications to the part and/or the documentation of the part, in order to implement improvements. Pasternack reserves the right to make such changes as required. Unless otherwise stated, all specifications are nominal.

PE8736 CAD Drawing

3 Section Tunable Band Reject Filter With N Female Connectors
Operating From 250 MHz to 500 MHz With a 1% Bandwidth

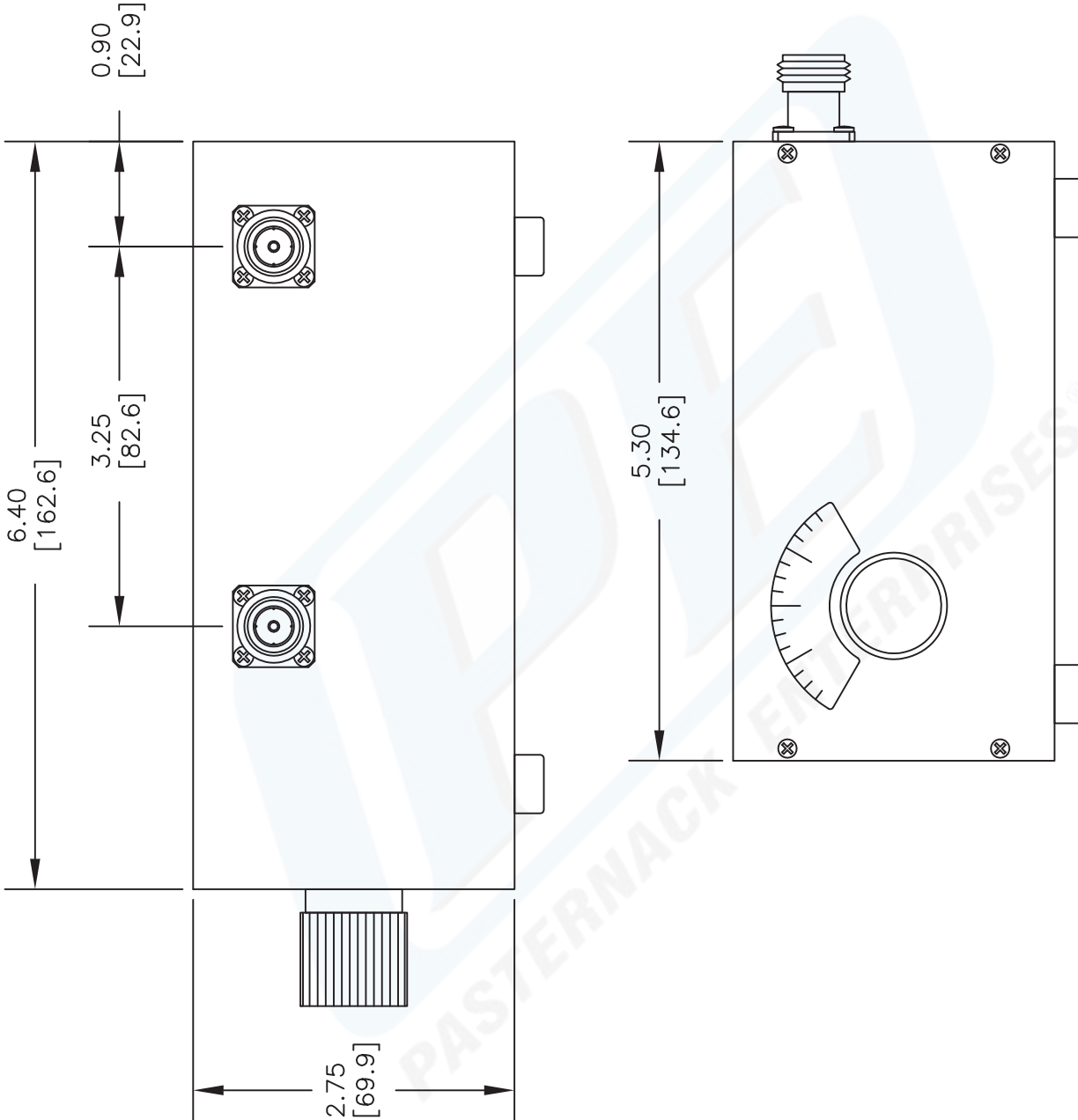

NOTES:
1. UNLESS OTHERWISE SPECIFIED ALL DIMENSIONS ARE NOMINAL.
2. ALL SPECIFICATIONS ARE SUBJECT TO CHANGE WITHOUT NOTICE AT ANY TIME.
3. DIMENSIONS ARE IN INCHES [mm].

DWG TITLE
PE8736

FSCM NO. 53919

CAD FILE 091013

SCALE N/A

SIZE A

2233

PE PASTERNAK®
Pasternack Enterprises, Inc.
P.O. Box 16759 | Irvine | CA | 92623
Phone: (949) 261-1920 | Fax: (949) 261-7451
Website: www.pasternack.com | E-Mail: sales@pasternack.com