



PESDxL2BT series

Low capacitance double bidirectional ESD protection diodes in SOT23

Rev. 01 — 1 November 2005

Product data sheet

1. Product profile

1.1 General description

Low capacitance double bidirectional ElectroStatic Discharge (ESD) protection diodes in a SOT23 small Surface Mounted Device (SMD) plastic package designed to protect two signal lines from the damage caused by ESD and other transients.

1.2 Features

- ESD protection of two lines
- Max. peak pulse power: $P_{PP} = 350$ W
- Low clamping voltage: $V_{CL} = 26$ V
- Small SMD plastic package
- Ultra low leakage current: $I_{RM} < 90$ nA
- ESD protection up to 23 kV
- IEC 61000-4-2, level 4 (ESD)
- IEC 61000-4-5 (surge); $I_{PP} = 15$ A

1.3 Applications

- Computers and peripherals
- Audio and video equipment
- Cellular handsets and accessories
- Communication systems
- Portable electronics
- Subscriber Identity Module (SIM) card protection

1.4 Quick reference data

Table 1: Quick reference data

Symbol	Parameter	Conditions	Min	Typ	Max	Unit
V_{RWM}	reverse standoff voltage					
	PESD3V3L2BT		-	-	3.3	V
	PESD5V0L2BT		-	-	5.0	V
	PESD12VL2BT		-	-	12	V
	PESD15VL2BT		-	-	15	V
	PESD24VL2BT		-	-	24	V
C_d	diode capacitance	$V_R = 0$ V; $f = 1$ MHz				
	PESD3V3L2BT		-	101	-	pF
	PESD5V0L2BT		-	75	-	pF
	PESD12VL2BT		-	19	-	pF
	PESD15VL2BT		-	16	-	pF
	PESD24VL2BT		-	11	-	pF

PHILIPS

2. Pinning information

Table 2: Pinning

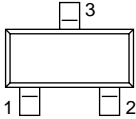
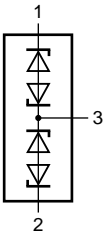
Pin	Description	Simplified outline	Symbol
1	cathode 1		 <p>006aaa155</p>
2	cathode 2		
3	double cathode		

3. Ordering information

Table 3: Ordering information

Type number	Package		
	Name	Description	Version
PESD3V3L2BT	-	plastic surface mounted package; 3 leads	SOT23
PESD5V0L2BT			
PESD12VL2BT			
PESD15VL2BT			
PESD24VL2BT			

4. Marking

Table 4: Marking codes

Type number	Marking code ^[1]
PESD3V3L2BT	V3*
PESD5V0L2BT	V4*
PESD12VL2BT	V5*
PESD15VL2BT	V6*
PESD24VL2BT	V7*

[1] * = -: made in Hong Kong
 * = p: made in Hong Kong
 * = t: made in Malaysia
 * = W: made in China

5. Limiting values

Table 5: Limiting values

In accordance with the Absolute Maximum Rating System (IEC 60134).

Symbol	Parameter	Conditions	Min	Max	Unit
P _{PP}	peak pulse power	t _p = 8/20 μs	[1] [2]		
	PESD3V3L2BT		-	350	W
	PESD5V0L2BT		-	350	W
	PESD12VL2BT		-	200	W
	PESD15VL2BT		-	200	W
	PESD24VL2BT		-	200	W
I _{PP}	peak pulse current	t _p = 8/20 μs	[1] [2]		
	PESD3V3L2BT		-	15	A
	PESD5V0L2BT		-	13	A
	PESD12VL2BT		-	5	A
	PESD15VL2BT		-	5	A
	PESD24VL2BT		-	3	A
T _j	junction temperature		-	150	°C
T _{amb}	ambient temperature		-65	+150	°C
T _{stg}	storage temperature		-65	+150	°C

[1] Non-repetitive current pulse 8/20 μs exponential decay waveform according to IEC 61000-4-5.

[2] Measured from pin 1 to 3 or 2 to 3.

Table 6: ESD maximum ratings

Symbol	Parameter	Conditions	Min	Max	Unit
V _{ESD}	electrostatic discharge voltage	IEC 61000-4-2 (contact discharge)	[1] [2]		
	PESD3V3L2BT		-	30	kV
	PESD5V0L2BT				
	PESD12VL2BT				
	PESD15VL2BT				
	PESD24VL2BT		-	23	kV
	PESDxL2BT series	HBM MIL-STD883	-	10	kV

[1] Device stressed with ten non-repetitive ESD pulses.

[2] Measured from pin 1 to 3 or 2 to 3.

Table 7: ESD standards compliance

ESD Standard	Conditions
IEC 61000-4-2, level 4 (ESD)	> 15 kV (air); > 8 kV (contact)
HBM MIL-STD883, class 3	> 4 kV

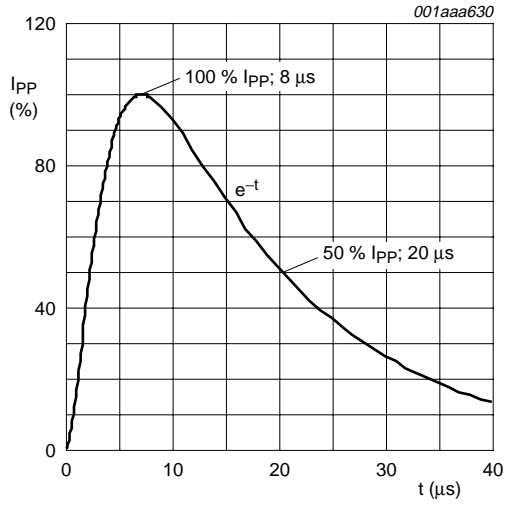

Fig 1. 8/20 μs pulse waveform according to IEC 61000-4-5

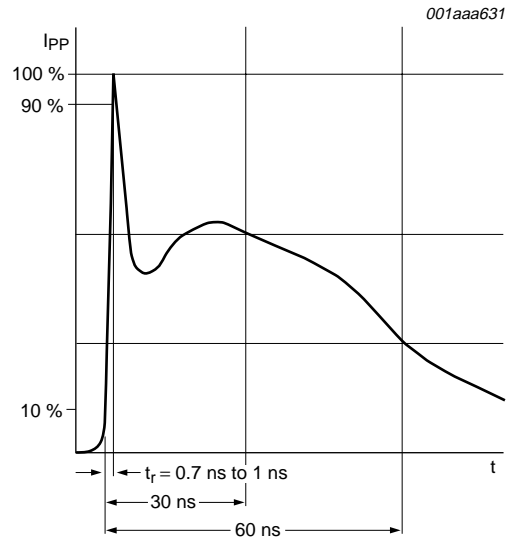

Fig 2. ESD pulse waveform according to IEC 61000-4-2

6. Characteristics

Table 8: Characteristics
T_{amb} = 25 °C unless otherwise specified.

Symbol	Parameter	Conditions	Min	Typ	Max	Unit
V _{RWM}	reverse standoff voltage					
	PESD3V3L2BT		-	-	3.3	V
	PESD5V0L2BT		-	-	5.0	V
	PESD12VL2BT		-	-	12	V
	PESD15VL2BT		-	-	15	V
	PESD24VL2BT		-	-	24	V
I _{RM}	reverse leakage current					
	PESD3V3L2BT	V _{RWM} = 3.3 V	-	0.09	2	μA
	PESD5V0L2BT	V _{RWM} = 5.0 V	-	0.01	1	μA
	PESD12VL2BT	V _{RWM} = 12 V	-	< 1	50	nA
	PESD15VL2BT	V _{RWM} = 15 V	-	< 1	50	nA
	PESD24VL2BT	V _{RWM} = 24 V	-	< 1	50	nA
V _{BR}	breakdown voltage	I _R = 5 mA				
	PESD3V3L2BT		5.8	6.4	6.9	V
	PESD5V0L2BT		7.0	7.6	8.2	V
	PESD12VL2BT		14.2	15.8	16.7	V
	PESD15VL2BT		17.1	18.8	20.3	V
	PESD24VL2BT		25.4	27.8	30.3	V
C _d	diode capacitance	V _R = 0 V; f = 1 MHz				
	PESD3V3L2BT		-	101	-	pF
	PESD5V0L2BT		-	75	-	pF
	PESD12VL2BT		-	19	-	pF
	PESD15VL2BT		-	16	-	pF
	PESD24VL2BT		-	11	-	pF
V _{CL}	clamping voltage					
	PESD3V3L2BT	I _{PP} = 1 A	-	-	8	V
		I _{PP} = 15 A	-	-	26	V
	PESD5V0L2BT	I _{PP} = 1 A	-	-	10	V
		I _{PP} = 13 A	-	-	28	V
	PESD12VL2BT	I _{PP} = 1 A	-	-	20	V
		I _{PP} = 5 A	-	-	37	V
	PESD15VL2BT	I _{PP} = 1 A	-	-	25	V
		I _{PP} = 5 A	-	-	44	V
	PESD24VL2BT	I _{PP} = 1 A	-	-	40	V
		I _{PP} = 3 A	-	-	70	V

Table 8: Characteristics ...continued
 $T_{amb} = 25^{\circ}\text{C}$ unless otherwise specified.

Symbol	Parameter	Conditions	Min	Typ	Max	Unit
r_{dif}	differential resistance	$I_R = 1\text{ mA}$				
	PESD3V3L2BT		-	-	400	Ω
	PESD5V0L2BT		-	-	80	Ω
	PESD12VL2BT		-	-	200	Ω
	PESD15VL2BT		-	-	225	Ω
PESD24VL2BT		-	-	300	Ω	

[1] Non-repetitive current pulse 8/20 μs exponential decay waveform according to IEC 61000-4-5.

[2] Measured from pin 1 to 3 or 2 to 3.

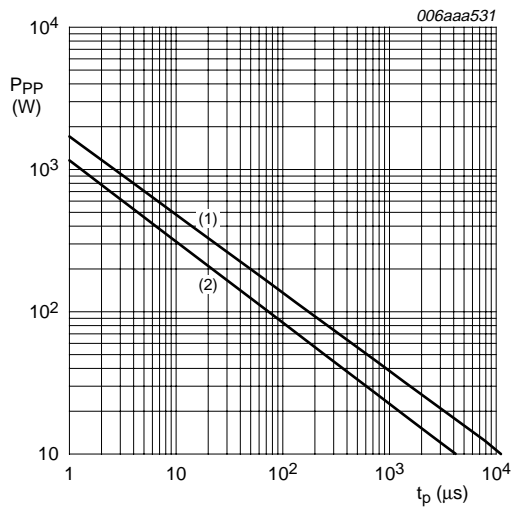

T_{amb} = 25 °C

- (1) PESD3V3L2BT and PESD5V0L2BT
- (2) PESD12VL2BT, PESD15VL2BT, PESD24VL2BT

Fig 3. Peak pulse power as a function of exponential pulse duration t_p; typical values

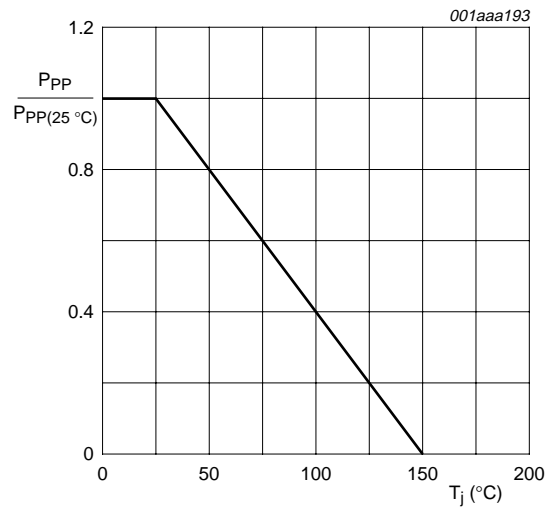
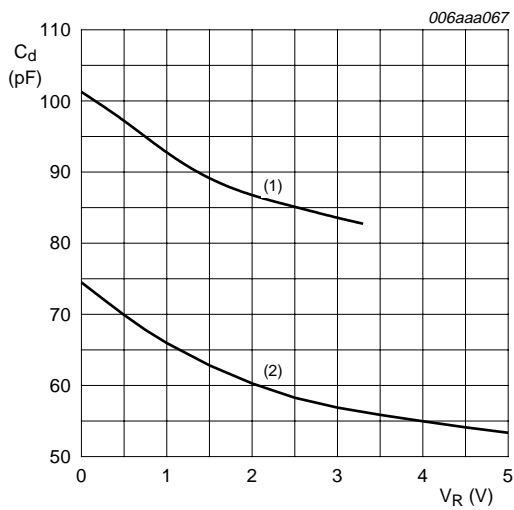

Fig 4. Relative variation of peak pulse power as a function of junction temperature; typical values



T_{amb} = 25 °C; f = 1 MHz

- (1) PESD3V3L2BT
- (2) PESD5V0L2BT

Fig 5. Diode capacitance as a function of reverse voltage; typical values

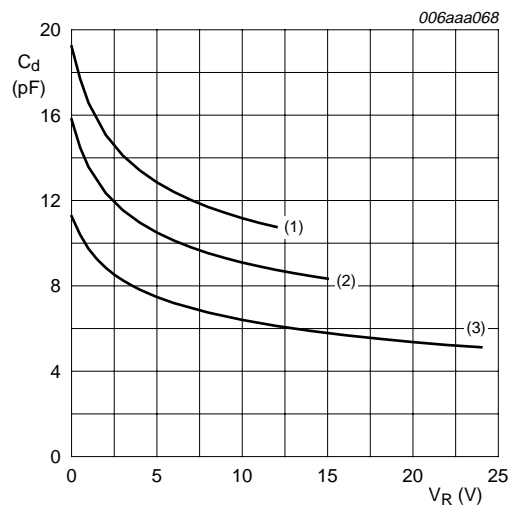

T_{amb} = 25 °C; f = 1 MHz

- (1) PESD12VL2BT
- (2) PESD15VL2BT
- (3) PESD24VL2BT

Fig 6. Diode capacitance as a function of reverse voltage; typical values

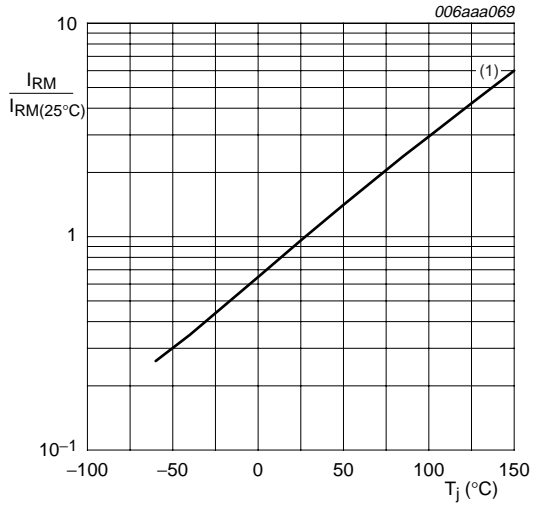

(1) PESD3V3L2BT, PESD5V0L2BT
 PESD12VL2BT, PESD15VL2BT and
 PESD24VL2BT: $I_{RM} < 20 \text{ nA}$; $T_j = 150 \text{ }^\circ\text{C}$

Fig 7. Relative variation of reverse leakage current as a function of junction temperature; typical values

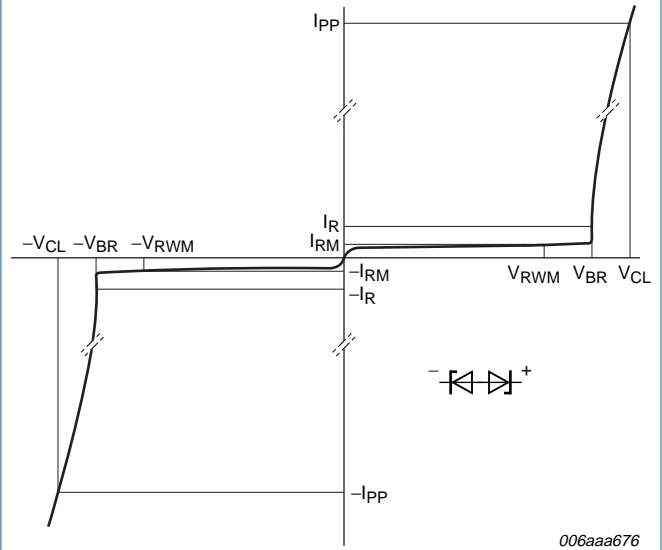

Fig 8. V-I characteristics for a bidirectional ESD protection diode

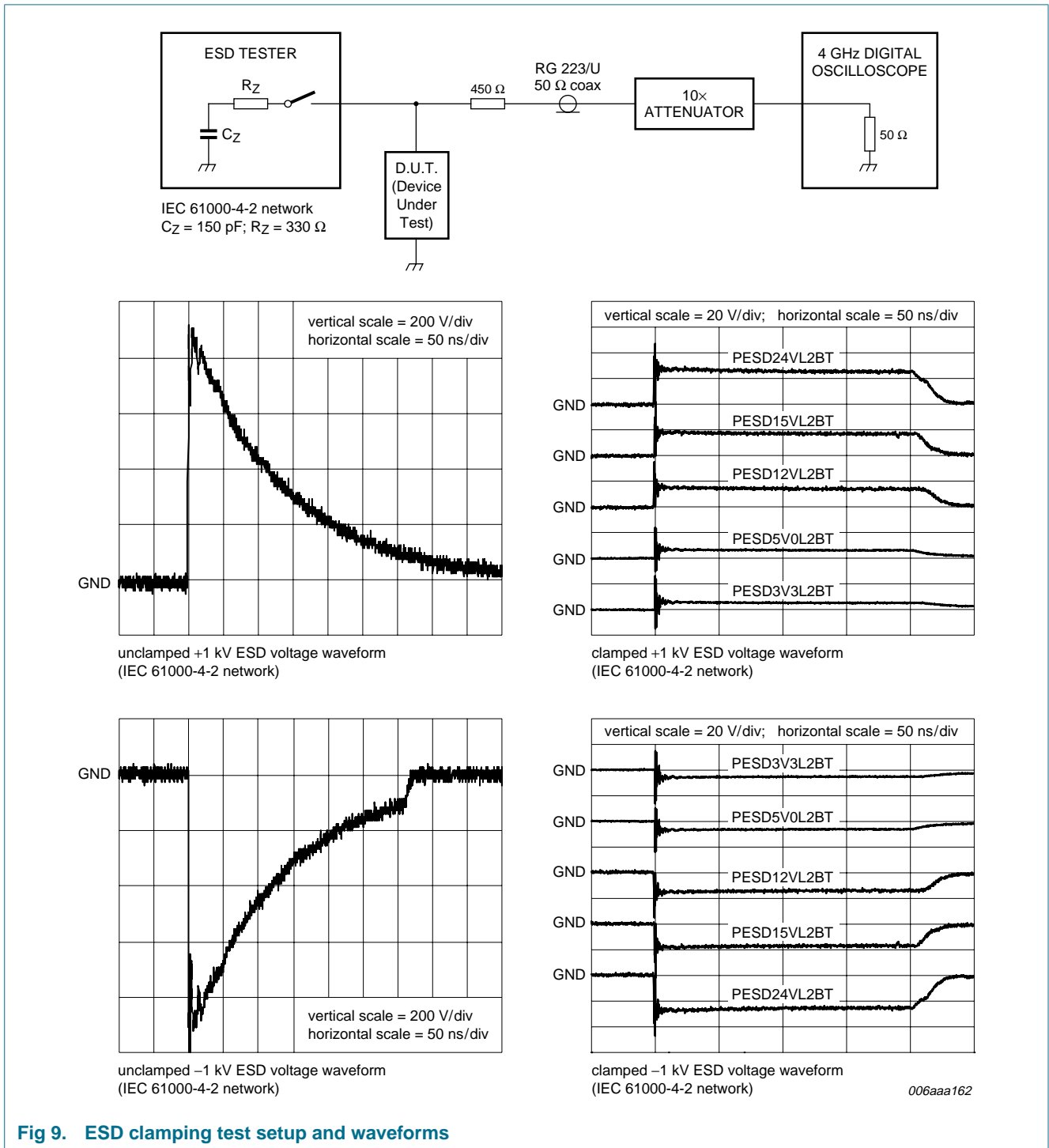
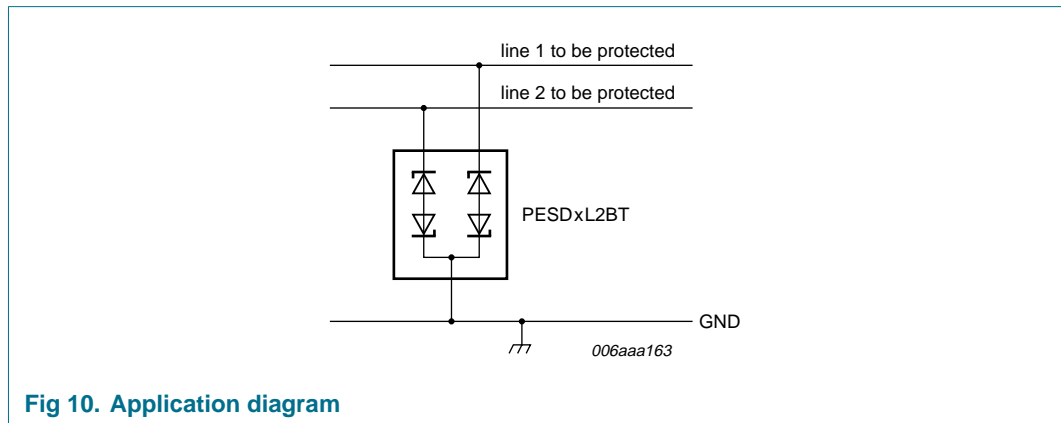

Fig 9. ESD clamping test setup and waveforms

7. Application information

The PESDxL2BT series is designed for the protection of two bidirectional signal lines from the damage caused by ESD and surge pulses. The PESDxL2BT series may be used on lines where the signal polarities are above and below ground. The PESDxL2BT series provides a surge capability of up to 350 W per line for an 8/20 μ s waveform.



Circuit board layout and protection device placement

Circuit board layout is critical for the suppression of ESD, Electrical Fast Transient (EFT) and surge transients. The following guidelines are recommended:

1. Place the PESDxL2BT as close to the input terminal or connector as possible.
2. The path length between the PESDxL2BT and the protected line should be minimized.
3. Keep parallel signal paths to a minimum.
4. Avoid running protected conductors in parallel with unprotected conductors.
5. Minimize all Printed-Circuit Board (PCB) conductive loops including power and ground loops.
6. Minimize the length of the transient return path to ground.
7. Avoid using shared transient return paths to a common ground point.
8. Ground planes should be used whenever possible. For multilayer PCBs, use ground vias.

8. Package outline

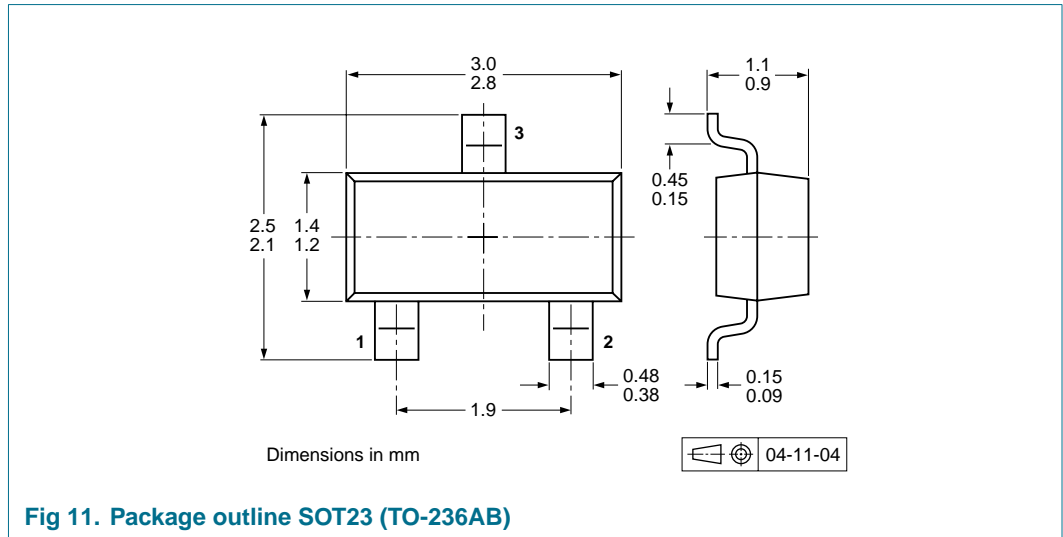

9. Packing information

Table 9: Packing methods

The indicated -xxx are the last three digits of the 12NC ordering code. [\[1\]](#)

Type number	Package	Description	Packing quantity	
			3000	10000
PESD3V3L2BT	SOT23	4 mm pitch, 8 mm tape and reel	-215	-235
PESD5V0L2BT				
PESD12VL2BT				
PESD15VL2BT				
PESD24VL2BT				

[1] For further information and the availability of packing methods, see [Section 15](#).

10. Revision history

Table 10: Revision history

Document ID	Release date	Data sheet status	Change notice	Doc. number	Supersedes
PESDXL2BT_SER_1	20051101	Product data sheet	-	9397 750 14034	-

11. Data sheet status

Level	Data sheet status ^[1]	Product status ^{[2] [3]}	Definition
I	Objective data	Development	This data sheet contains data from the objective specification for product development. Philips Semiconductors reserves the right to change the specification in any manner without notice.
II	Preliminary data	Qualification	This data sheet contains data from the preliminary specification. Supplementary data will be published at a later date. Philips Semiconductors reserves the right to change the specification without notice, in order to improve the design and supply the best possible product.
III	Product data	Production	This data sheet contains data from the product specification. Philips Semiconductors reserves the right to make changes at any time in order to improve the design, manufacturing and supply. Relevant changes will be communicated via a Customer Product/Process Change Notification (CPCN).

[1] Please consult the most recently issued data sheet before initiating or completing a design.

[2] The product status of the device(s) described in this data sheet may have changed since this data sheet was published. The latest information is available on the Internet at URL <http://www.semiconductors.philips.com>.

[3] For data sheets describing multiple type numbers, the highest-level product status determines the data sheet status.

12. Definitions

Short-form specification — The data in a short-form specification is extracted from a full data sheet with the same type number and title. For detailed information see the relevant data sheet or data handbook.

Limiting values definition — Limiting values given are in accordance with the Absolute Maximum Rating System (IEC 60134). Stress above one or more of the limiting values may cause permanent damage to the device. These are stress ratings only and operation of the device at these or at any other conditions above those given in the Characteristics sections of the specification is not implied. Exposure to limiting values for extended periods may affect device reliability.

Application information — Applications that are described herein for any of these products are for illustrative purposes only. Philips Semiconductors make no representation or warranty that such applications will be suitable for the specified use without further testing or modification.

13. Disclaimers

Life support — These products are not designed for use in life support appliances, devices, or systems where malfunction of these products can reasonably be expected to result in personal injury. Philips Semiconductors

15. Contact information

For additional information, please visit: <http://www.semiconductors.philips.com>

For sales office addresses, send an email to: sales.addresses@www.semiconductors.philips.com

customers using or selling these products for use in such applications do so at their own risk and agree to fully indemnify Philips Semiconductors for any damages resulting from such application.

Right to make changes — Philips Semiconductors reserves the right to make changes in the products - including circuits, standard cells, and/or software - described or contained herein in order to improve design and/or performance. When the product is in full production (status 'Production'), relevant changes will be communicated via a Customer Product/Process Change Notification (CPCN). Philips Semiconductors assumes no responsibility or liability for the use of any of these products, conveys no license or title under any patent, copyright, or mask work right to these products, and makes no representations or warranties that these products are free from patent, copyright, or mask work right infringement, unless otherwise specified.

14. Trademarks

Notice — All referenced brands, product names, service names and trademarks are the property of their respective owners.

16. Contents

1	Product profile	1
1.1	General description	1
1.2	Features	1
1.3	Applications	1
1.4	Quick reference data	1
2	Pinning information	2
3	Ordering information	2
4	Marking	2
5	Limiting values	3
6	Characteristics	5
7	Application information	10
8	Package outline	11
9	Packing information	11
10	Revision history	12
11	Data sheet status	13
12	Definitions	13
13	Disclaimers	13
14	Trademarks	13
15	Contact information	13



© Koninklijke Philips Electronics N.V. 2005

All rights are reserved. Reproduction in whole or in part is prohibited without the prior written consent of the copyright owner. The information presented in this document does not form part of any quotation or contract, is believed to be accurate and reliable and may be changed without notice. No liability will be accepted by the publisher for any consequence of its use. Publication thereof does not convey nor imply any license under patent- or other industrial or intellectual property rights.

Date of release: 1 November 2005
Document number: 9397 750 14034

Published in The Netherlands