

PQxxxEN01ZPH Series

Low Voltage Operation, Compact Surface Mount type Low Power-Loss Voltage Regulators

■ Features

1. Low voltage operation
(Minimum operating voltage: 2.35V)
2. Output current : 1A
3. Low dissipation current
(Dissipation current at no load: MAX. 2mA
Output OFF-state dissipation current: MAX. 5μA)
4. Low power-loss
5. Built-in overcurrent and overheat protection functions
6. Conform to Flow Soldering SC-63 package
7. RoHS directive compliant

■ Applications

1. Personal computers and peripheral equipment
2. Power supplies for various digital electronic equipment such as DVD player or STB

■ Model Line-up

Output Voltage (TYP.)	Model No.
1.5V	PQ015EN01ZPH
1.8V	PQ018EN01ZPH
2.5V	PQ025EN01ZPH
3.0V	PQ030EN01ZPH
3.3V	PQ033EN01ZPH

■ Absolute Maximum Ratings

(Ta=25°C)

Parameter	Symbol	Rating	Unit
*1 Input voltage	V _{IN}	10	V
*1 Output control voltage	V _C	10	V
Output current	I _O	1	A
*2 Power dissipation	P _D	8	W
*3 Junction temperature	T _j	150	°C
Operating temperature	T _{opr}	-40 to +85	°C
Storage temperature	T _{stg}	-40 to +150	°C
Soldering temperature	T _{sol}	260(10s)	°C

*1 All are open except GND and applicable terminals.

*2 At surface-mounted condition

*3 Overheat protection may operate at T_j:125°C to 150°C

■ Outline Dimensions

(Unit : mm)

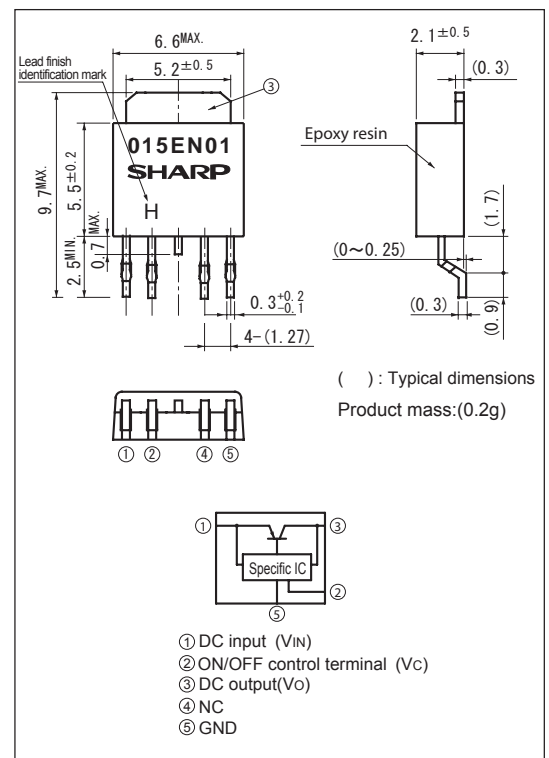

Lead finish: Lead-free solder plating
(Composition: Sn2Cu)

Notice The content of data sheet is subject to change without prior notice.

In the absence of confirmation by device specification sheets, SHARP takes no responsibility for any defects that may occur in equipment using any SHARP devices shown in catalogs, data books, etc. Contact SHARP in order to obtain the latest device specification sheets before using any SHARP device.

Electrical Characteristics

(Unless otherwise specified, condition shall be $V_{IN}=V_O(TYP.)+1V, I_O=0.5A, V_C=2.7V, T_a=25^\circ C$)

Parameter	Symbol	Conditions	MIN.	TYP.	MAX.	Unit
Input voltage	V_{IN}	-	Refer to the following table.1			V
Output voltage	V_O	-	Refer to the following table.2			V
Load regulation	RegL	$I_O=5mA$ to 1A	-	0.2	2	%
Line regulation	RegI	$V_{IN}=V_O(TYP.)+1V$ to $V_O(TYP.)+6V, I_O=5mA$	-	0.1	1	%
Temperature coefficient of output voltage	$T_C V_O$	$T_j=0$ to $+125^\circ C, I_O=5mA$	-	± 0.01	-	%/ $^\circ C$
Ripple rejection	RR	Refer to Fig.3	45	60	-	dB
*4 Dropout voltage	V_{I-O}	$I_O=0.5A$ *5	-	0.2	0.5	V
*6 ON-state voltage for control	$V_{C(ON)}$	-	2	-	-	V
ON-state current for control	$I_{C(ON)}$	-	-	-	200	μA
OFF-state voltage for control	$V_{C(OFF)}$	-	-	-	0.8	V
OFF-state current for control	$I_{C(OFF)}$	$V_C=0.4V$	-	-	2	μA
Quiescent current	I_q	$I_O=0A$	-	1	2	mA
Output OFF-state dissipation current	I_{qs}	$I_O=0A, V_C=0.4V$	-	-	5	μA

*4 Applied to PQ030EN01ZPH and PQ033EN01ZPH

*5 Input voltage shall be the value when output voltage is 95% in comparison with the initial value.

*6 In case of opening control terminal ②, output voltage turns off

Table.1 Input Voltage range

(Unless otherwise specified, condition shall be $I_O=0.5A, V_C=2.7V, T_a=25^\circ C$)

Model No.	Symbol	Conditions	MIN.	TYP.	MAX.	Unit
PQ015EN01ZPH	V_{IN}	-	2.35	-	10	V
PQ018EN01ZPH	V_{IN}	-	2.35	-	10	V
PQ025EN01ZPH	V_{IN}	-	3.0	-	10	V
PQ030EN01ZPH	V_{IN}	-	3.5	-	10	V
PQ033EN01ZPH	V_{IN}	-	3.8	-	10	V

Table.2 Output Voltage

(Unless otherwise specified, condition shall be $V_{IN}=V_O(TYP.)+1V, I_O=0.5A, V_C=2.7V, T_a=25^\circ C$)

Model No.	Symbol	Conditions	MIN.	TYP.	MAX.	Unit
PQ015EN01ZPH	V_O	-	1.45	1.5	1.55	V
PQ018EN01ZPH	V_O	-	1.75	1.8	1.85	V
PQ025EN01ZPH	V_O	-	2.438	2.5	2.562	V
PQ030EN01ZPH	V_O	-	2.925	3.0	3.075	V
PQ033EN01ZPH	V_O	-	3.218	3.3	3.382	V

Fig.1 Typical Application

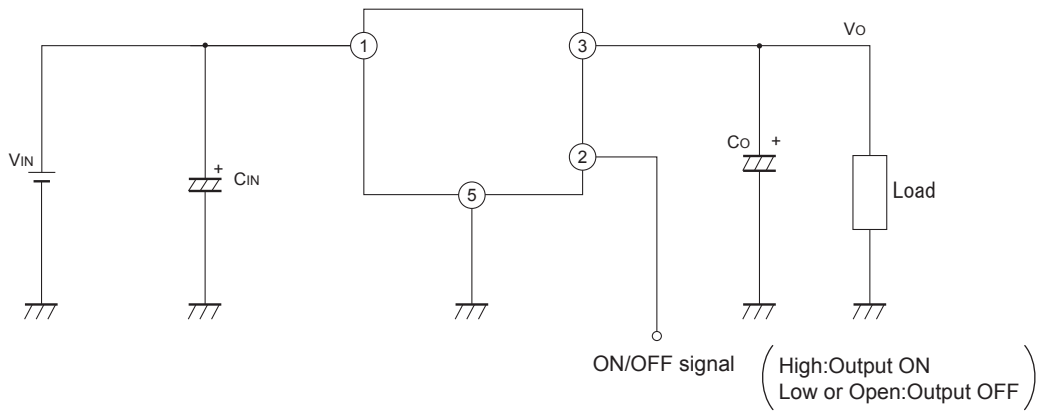

Fig.2 Test Circuit

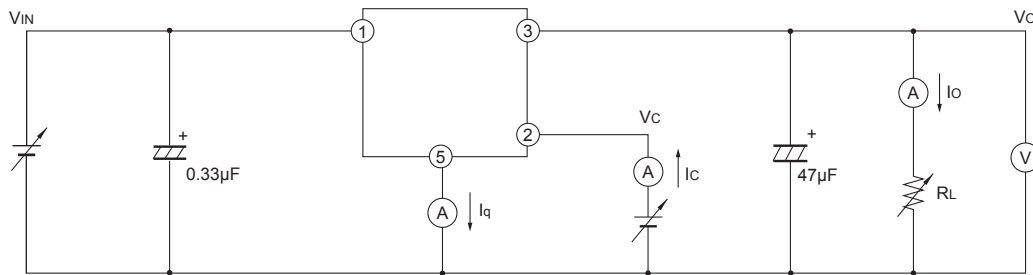

Fig.3 Test Circuit for Ripple Rejection

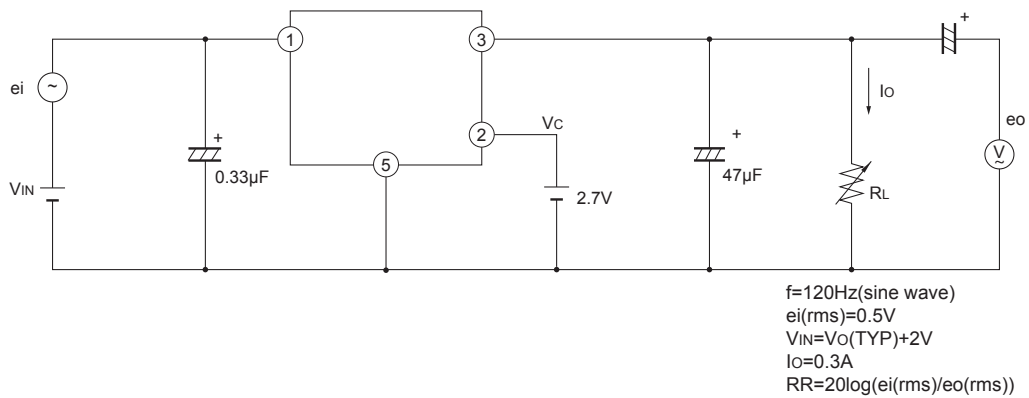
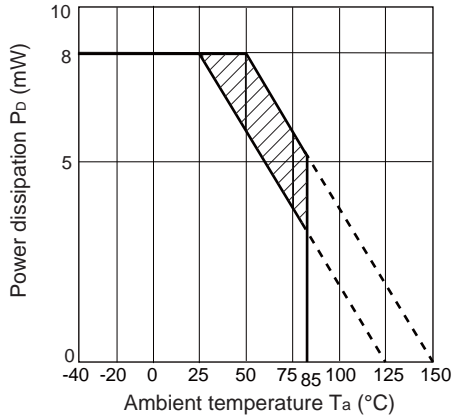

Fig.4 Power Dissipation vs. Ambient Temperature



Note) Oblique line portion: Overheat protection may operate in this area.

Fig.5 Overcurrent Protection Characteristics (PQ015EN01ZPH)

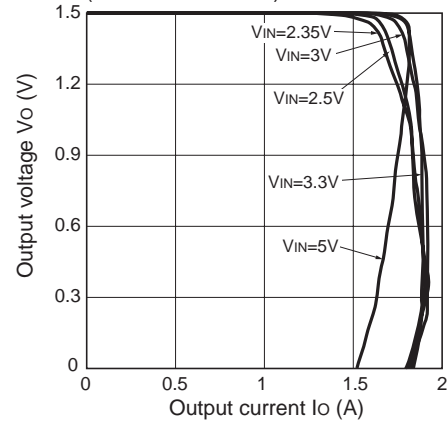

Fig.6 Overcurrent Protection Characteristics (PQ018EN01ZPH)

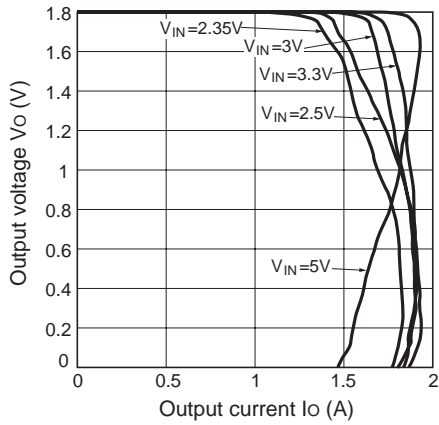

Fig.7 Overcurrent Protection Characteristics (PQ025EN01ZPH)

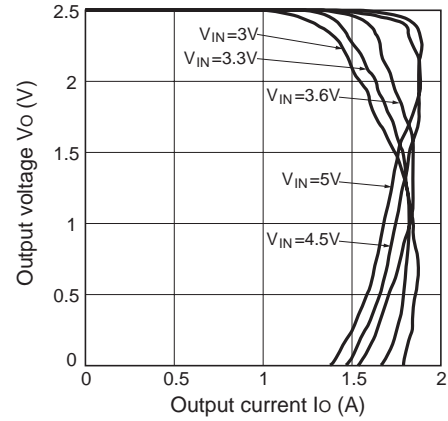

Fig.8 Overcurrent Protection Characteristics (PQ030EN01ZPH)

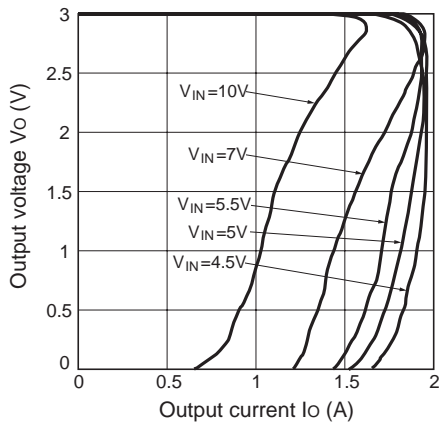

Fig.9 Overcurrent Protection Characteristics (PQ033EN01ZPH)

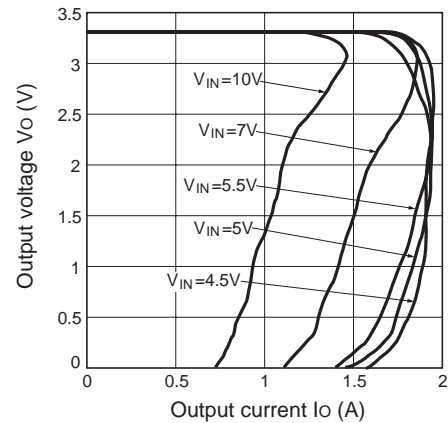

Fig.10 Output Voltage vs. Ambient Temperature (PQ015EN01ZPH)

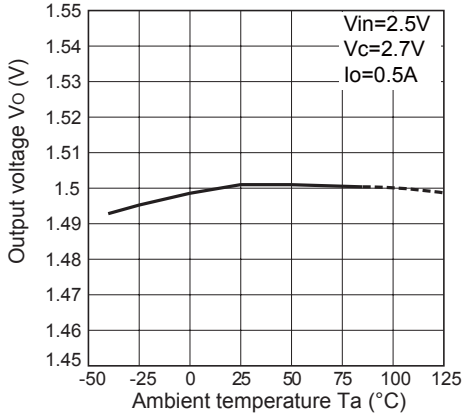

Fig.11 Output Voltage vs. Ambient Temperature (PQ018EN01ZPH)

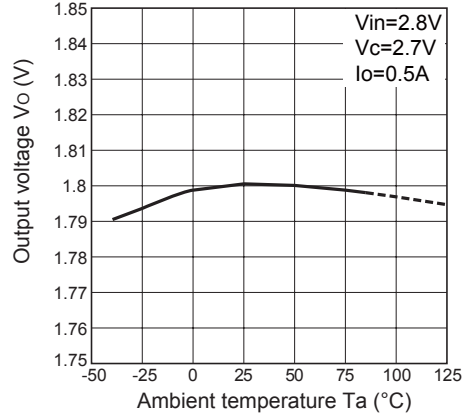

Fig.12 Output Voltage vs. Ambient Temperature (PQ025EN01ZPH)

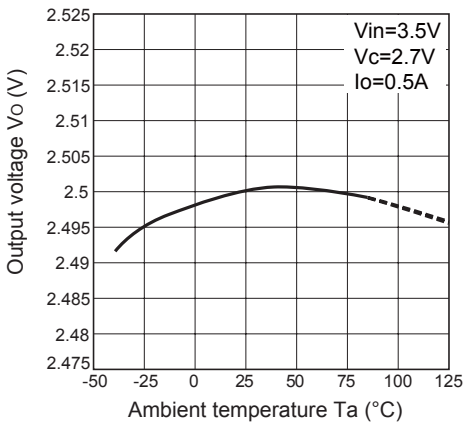

Fig.13 Output Voltage vs. Ambient Temperature (PQ030EN01ZPH)

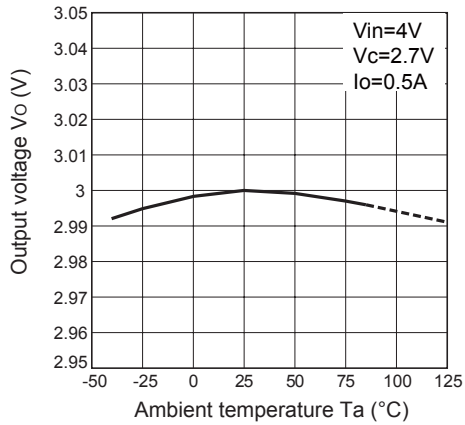

Fig.14 Output Voltage vs. Ambient Temperature (PQ033EN01ZPH)

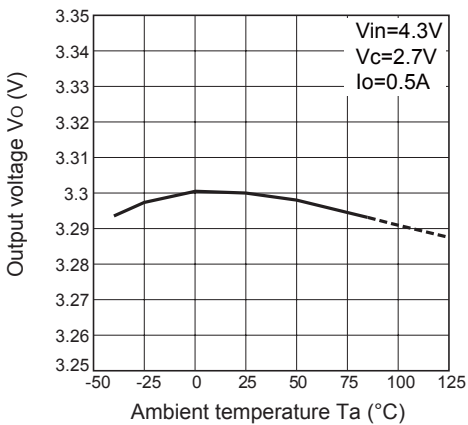

Fig.15 Output Voltage vs. Input Voltage (PQ015EN01ZPH)

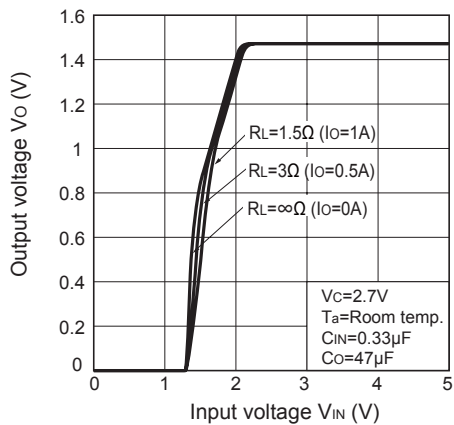

Fig.16 Output Voltage vs. Input Voltage (PQ018EN01ZPH)

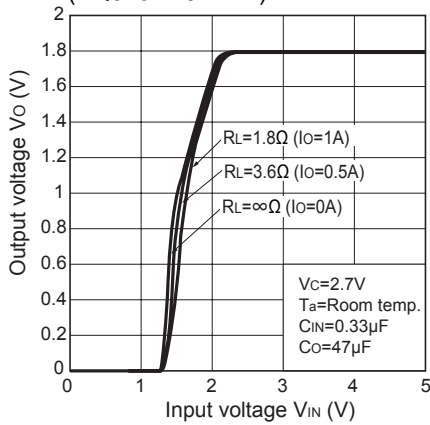

Fig.17 Output Voltage vs. Input Voltage (PQ025EN01ZPH)

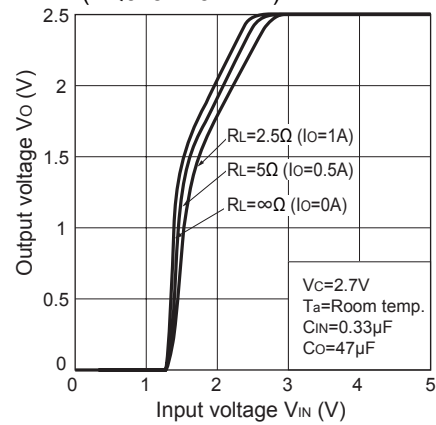

Fig.18 Output Voltage vs. Input Voltage (PQ030EN01ZPH)

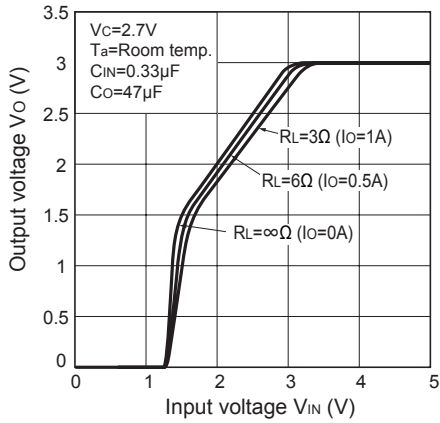

Fig.19 Output Voltage vs. Input Voltage (PQ033EN01ZPH)

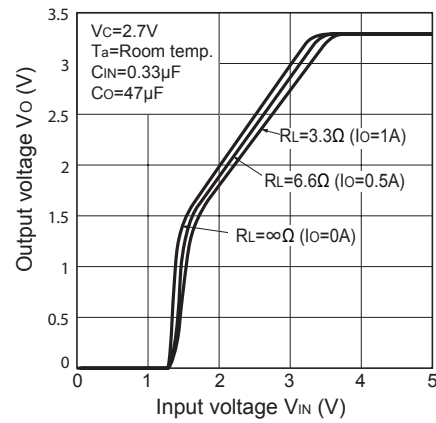

Fig.20 Circuit Operating Current vs. Input Voltage (PQ015EN01ZPH)

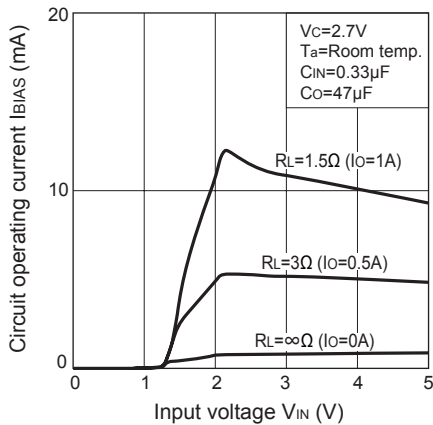

Fig.21 Circuit Operating Current vs. Input Voltage (PQ018EN01ZPH)

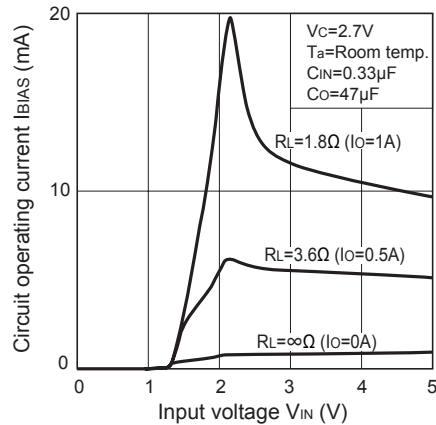

Fig.22 Circuit Operating Current vs. Input Voltage (PQ025EN01ZPH)

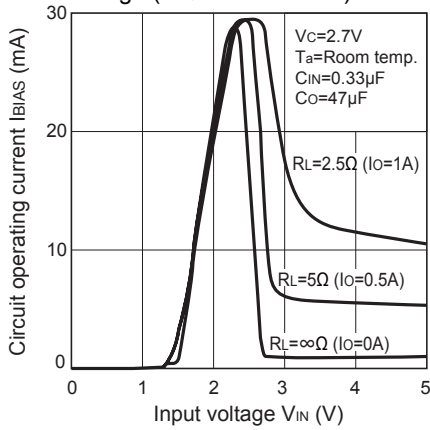

Fig.23 Circuit Operating Current vs. Input Voltage (PQ030EN01ZPH)

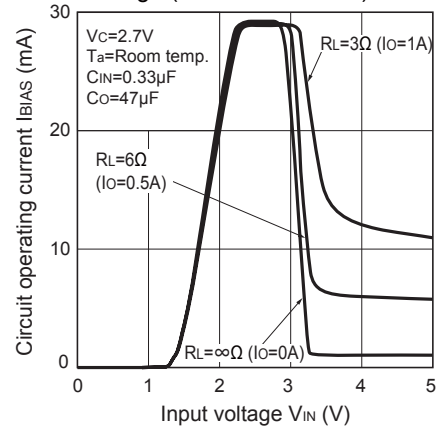

Fig.24 Circuit Operating Current vs. Input Voltage (PQ033EN01ZPH)

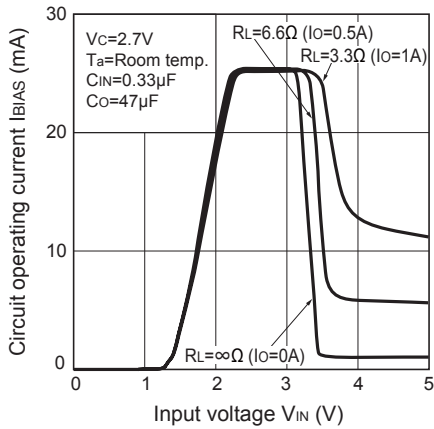

Fig.25 Quiescent Current vs. Junction Temperature (PQxxxEN01ZPH)

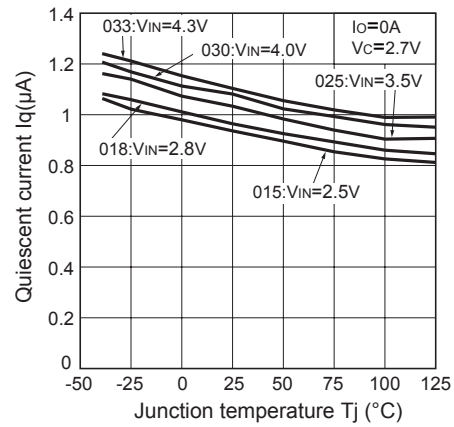

Fig.26 Dropout Voltage vs. Junction Temperature (PQ030EN01ZPH, PQ033EN01ZPH)

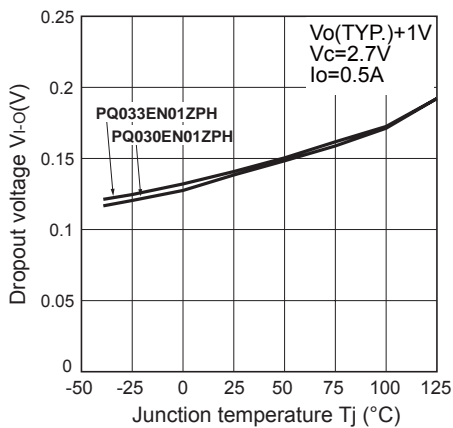

Fig.27 Ripple Rejection vs. Input Ripple Frequency (PQxxxEN01ZPH)

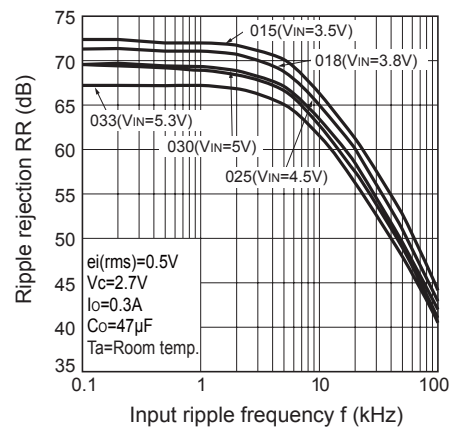

Fig.28 Ripple Rejection vs. Output Current (PQxxxEN01ZPH)

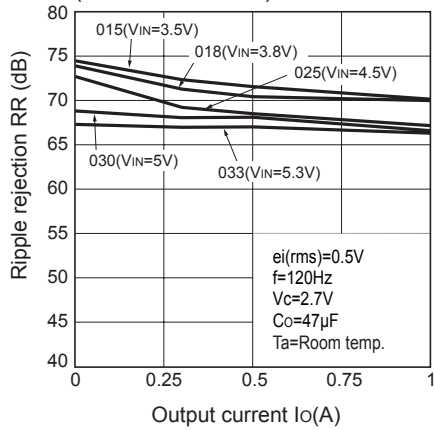
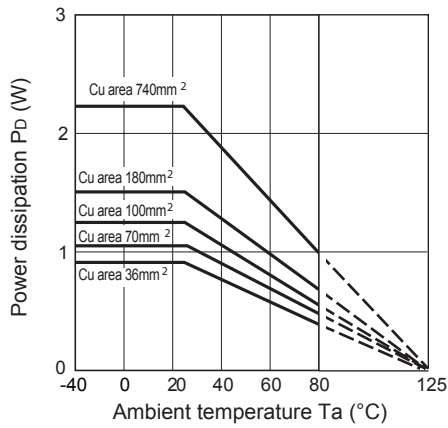
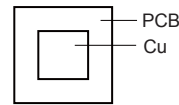

Fig.29 Power Dissipation vs. Ambient Temperature (Typical Value)



Mounting PCB



Material : Glass-cloth epoxy resin
 Size : 50×50×1.6mm
 Cu thickness : 35μm