

PQ05RH1/PQ05RH11 Series

1.5A Output, Low Power-Loss Voltage Regulators

Features

- Low power-loss (Dropout voltage: MAX. 0.5V)
- Compact resin full-mold package
- Built-in ON/OFF control terminal
- High-precision output (Output voltage precision: $\pm 2.5\%$) (PQ05RH11 Series)

Applications

- Series power supply for various electronic equipment such as VCRs and OA equipment.

Model Line-ups

Output voltage	5V Output	9V Output	12V Output
Output voltage precision: $\pm 5\%$	PQ05RH1	PQ09RH1	PQ12RH1
Output voltage precision: $\pm 2.5\%$	PQ05RH11	PQ09RH11	PQ12RH11

Equivalent Circuit Diagram

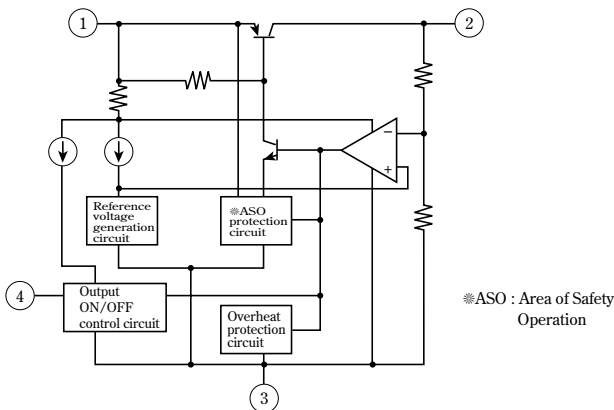

Outline Dimensions

(Unit : mm)

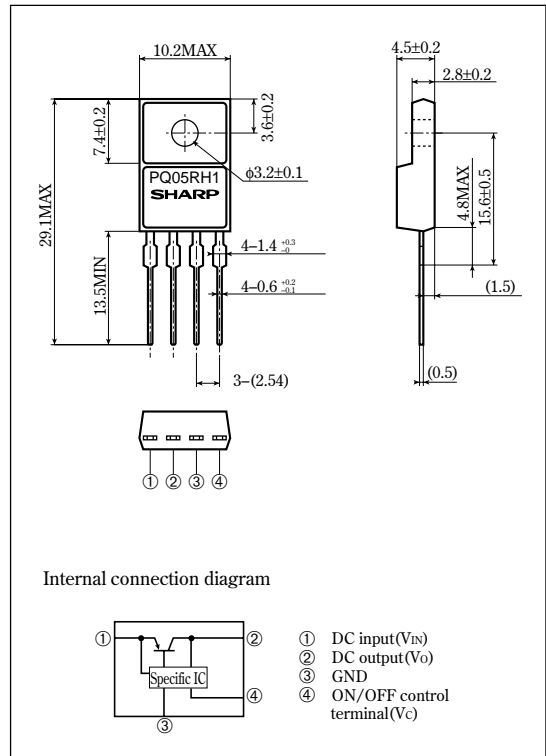

•Please refer to the chapter " Handling Precautions ".

SHARP

Absolute Maximum Ratings

($T_a=25^\circ\text{C}$)

Parameter	Symbol	Rating	Unit
*1 Input voltage	V_{IN}	35	V
*1 ON/OFF control terminal voltage	V_C	35	V
Output current	I_o	1.5	A
Power dissipation (No heat sink)	P_{D1}	1.5	W
Power dissipation (With infinite heat sink)	P_{D2}	18	W
*2 Junction temperature	T_j	150	$^\circ\text{C}$
Operating temperature	T_{opr}	-20 to +80	$^\circ\text{C}$
Storage temperature	T_{stg}	-40 to +150	$^\circ\text{C}$
Soldering temperature	T_{sol}	260 (For 10s)	$^\circ\text{C}$

*1 All are open except GND and applicable terminals.

*2 Overheat protection may operate at $125 \leq T_j < 150^\circ\text{C}$.

Electrical Characteristics

(Unless otherwise specified, condition shall be $I_o=0.5\text{A}$, $T_a=25^\circ\text{C}$ *)

Parameter	Symbol	Conditions	MIN.	TYP.	MAX.	Unit	
Output voltage	V_o	-	PQ05RH1	4.75	5.0	5.25	V
			PQ09RH1	8.55	9.0	9.45	
			PQ12RH1	11.4	12.0	12.6	
			PQ05RH11	4.88	5.0	5.12	
			PQ09RH11	8.78	9.0	9.22	
			PQ12RH11	11.7	12.0	12.3	
Load regulation	$RegL$	$I_o=5\text{mA}$ to 1.5A	-	0.3	2.0	%	
Line regulation	$RegI$	*4	-	0.5	2.5	%	
Temperature coefficient of output voltage	TcV_o	$T_j=0$ to 125°C	-	± 0.02	-	$\%/^\circ\text{C}$	
Ripple rejection	RR	Refer to Figs.2	45	55	-	dB	
Dropout voltage	V_{f-o}	*5	-	-	0.5	V	
ON-state voltage for control	$V_C(ON)$	-	2.0 *6	-	-	V	
ON-state current for control	$I_C(ON)$	$V_C=2.7\text{V}$	-	-	20	μA	
OFF-state voltage for control	$V_C(OFF)$	-	-	-	0.8	V	
OFF-state current for control	$I_C(OFF)$	$V_C=0.4\text{V}$	-	-	-0.4	mA	
Quiescent current	I_q	$I_o=0$	-	-	10	mA	

*3 PQ05RH1 series: $V_{IN}=7\text{V}$, PQ09RH1 series: $V_{IN}=15\text{V}$, PQ12RH1 series: $V_{IN}=18\text{V}$

*4 PQ05RH1/PQ05RH11: $V_{IN}=6$ to 12V
 PQ09RH1/PQ09RH11: $V_{IN}=10$ to 25V
 PQ12RH1/PQ12RH11: $V_{IN}=13$ to 29V

*5 Input voltage shall be the value when output voltage is 95% in comparison with the initial value.

*6 In case of opening control terminal ④, output voltage turns on.

Fig.1 Test Circuit

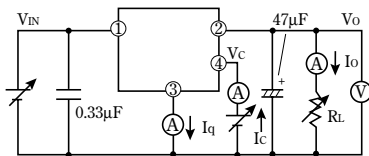
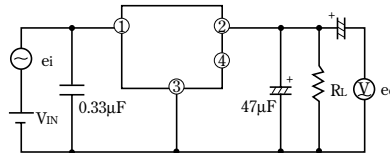
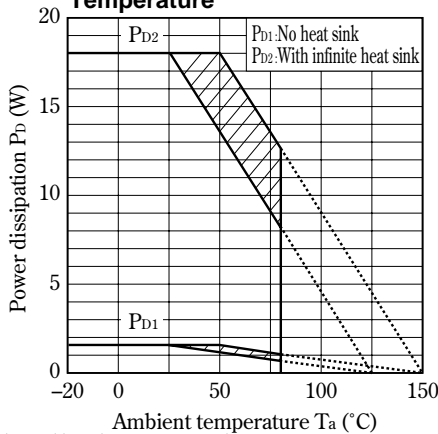

Fig.2 Test Circuit of Ripple Rejection



$f=120\text{Hz}$ (sine wave)
 $e_i(\text{rms})=0.5\text{V}$
 $RR=20 \log(e_i(\text{rms})/e_o(\text{rms}))$

Fig.3 Power Dissipation vs. Ambient Temperature



Note) Oblique line portion : Overheat protection may operate in this area.

Fig.4 Overcurrent Protection Characteristics (Typical value)

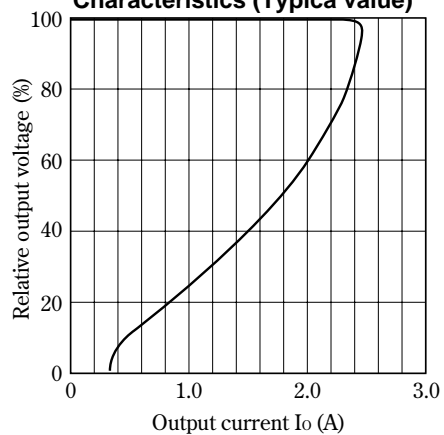

Fig.5 Output Voltage Deviation vs. Junction Temperature (PQ05RH1/PQ05RH11)

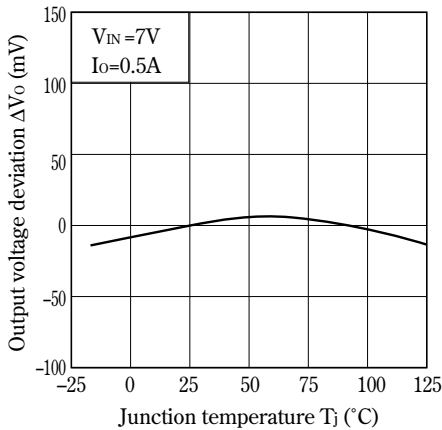

Fig.6 Output Voltage Deviation vs. Junction Temperature (PQ09RH1/PQ09RH11)

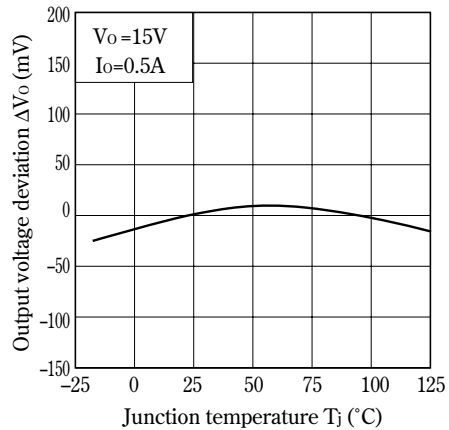

Fig.7 Output Voltage Deviation vs. Junction Temperature (PQ12RH1/PQ12RH11)

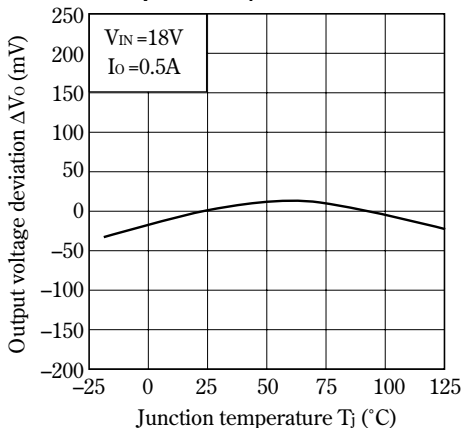

Fig.8 Output Voltage vs. Input Voltage (PQ05RH1/PQ05RH11)

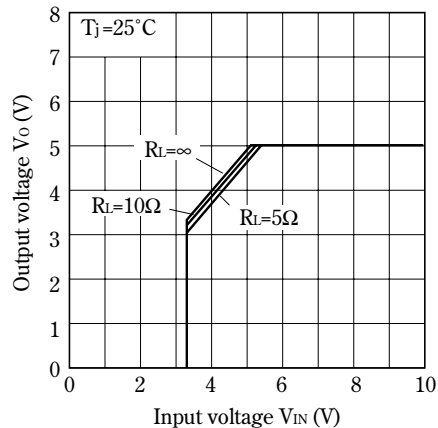

Fig.9 Output Voltage vs. Input Voltage (PQ09RH1/PQ09RH11)

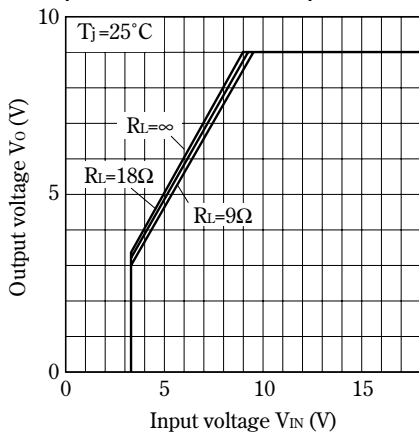

Fig.10 Output Voltage vs. Input Voltage (PQ12RH1/PQ12RH11)

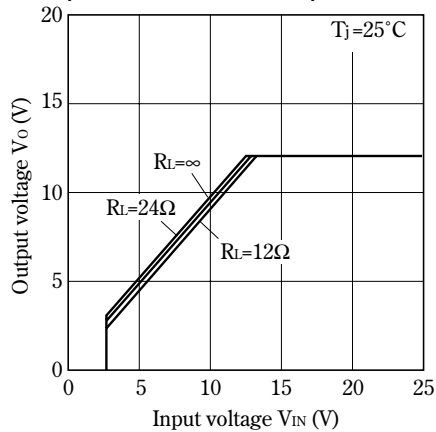

Fig.11 Circuit Operating Current vs. Input Voltage (PQ05RH1/PQ05RH11)

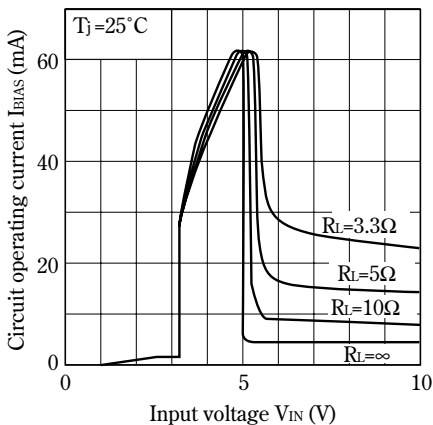

Fig.12 Circuit Operating Current vs. Input Voltage (PQ09RH1/PQ09RH11)

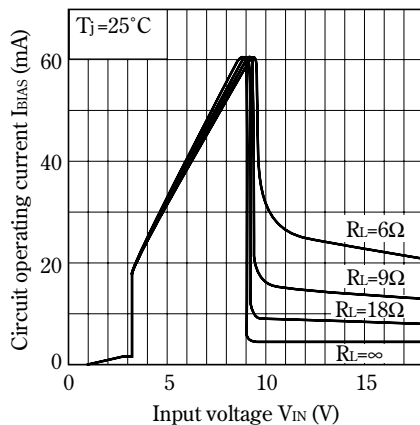

Fig.13 Circuit Operating Current vs. Input Voltage (PQ12RH1/PQ12RH11)

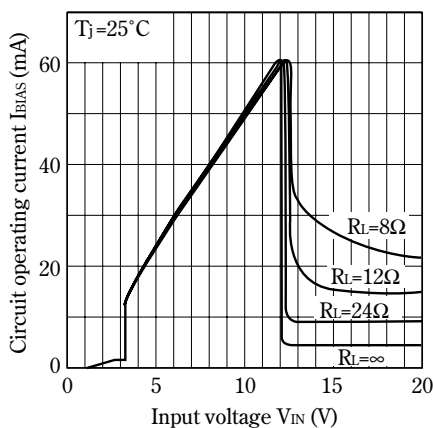

Fig.14 Dropout Voltage vs. Junction Temperature

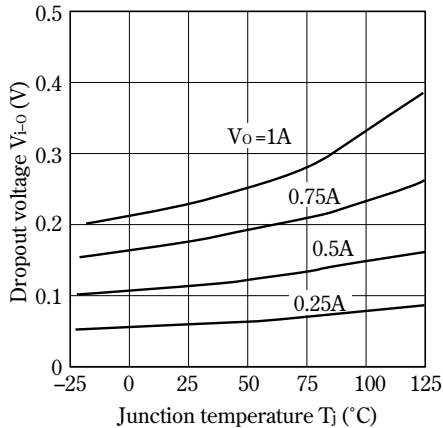

Fig.15 Quiescent Current vs. Junction Temperature

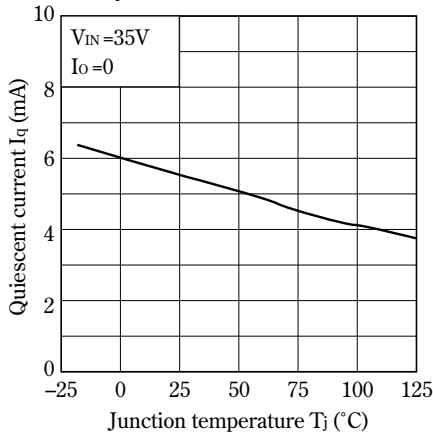

Fig.16 Repple Rejection vs. Input Ripple Frequency

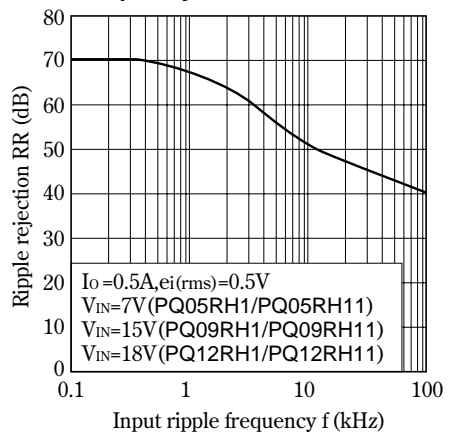

Fig.17 Ripple Rejection vs. Output Current

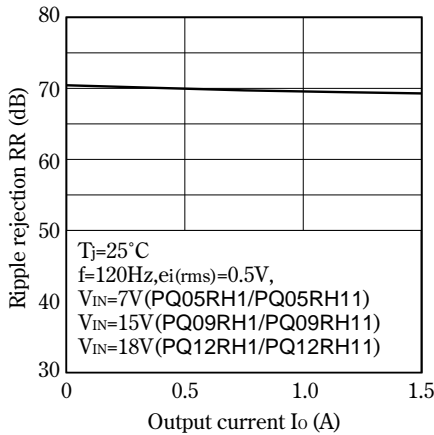
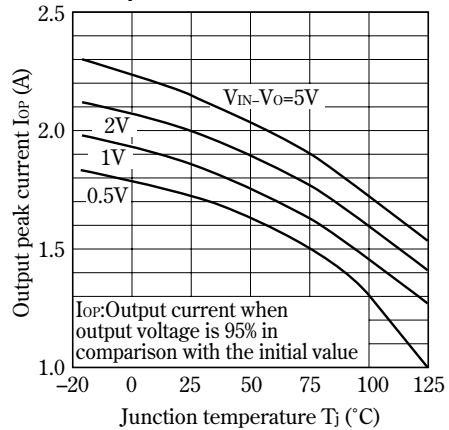
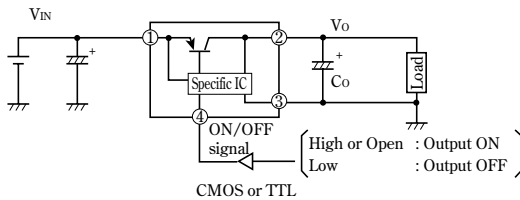

Fig.18 Output Peak Current vs. Junction Temperature



■ Typical Application



Model Line-ups for Lead Forming Type

Output voltage	5V Output	9V Output	12V Output
Output voltage precision:±5%	PQ05RH1A	PQ09RH1A	PQ12RH1A
Output voltage precision:±2.5%	PQ05RH1B	PQ09RH1B	PQ12RH1B

Outline Dimensions (PQ05RH1A/PQ05RH1B Series)

(Unit : mm)

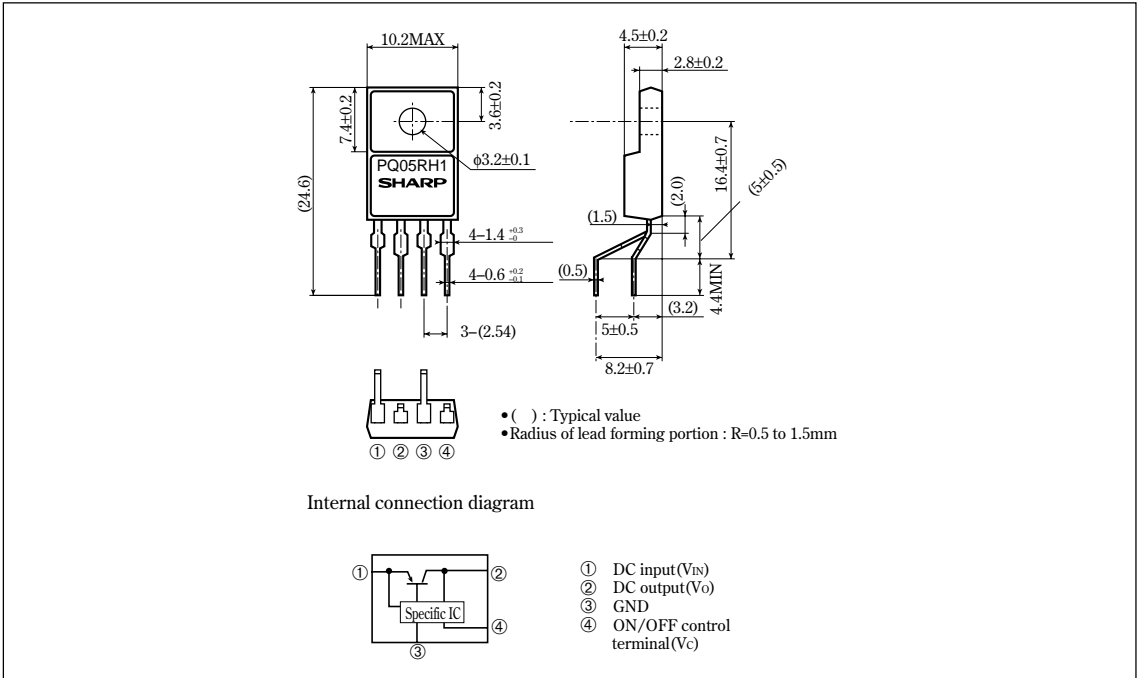

Note)The value of absolute maximum ratings and electrical characteristics is same as ones of PQ05RH1/11 series.

NOTICE

- The circuit application examples in this publication are provided to explain representative applications of SHARP devices and are not intended to guarantee any circuit design or license any intellectual property rights. SHARP takes no responsibility for any problems related to any intellectual property right of a third party resulting from the use of SHARP's devices.
- Contact SHARP in order to obtain the latest device specification sheets before using any SHARP device. SHARP reserves the right to make changes in the specifications, characteristics, data, materials, structure, and other contents described herein at any time without notice in order to improve design or reliability. Manufacturing locations are also subject to change without notice.
- Observe the following points when using any devices in this publication. SHARP takes no responsibility for damage caused by improper use of the devices which does not meet the conditions and absolute maximum ratings to be used specified in the relevant specification sheet nor meet the following conditions:
 - (i) The devices in this publication are designed for use in general electronic equipment designs such as:
 - Personal computers
 - Office automation equipment
 - Telecommunication equipment [terminal]
 - Test and measurement equipment
 - Industrial control
 - Audio visual equipment
 - Consumer electronics
 - (ii) Measures such as fail-safe function and redundant design should be taken to ensure reliability and safety when SHARP devices are used for or in connection with equipment that requires higher reliability such as:
 - Transportation control and safety equipment (i.e., aircraft, trains, automobiles, etc.)
 - Traffic signals
 - Gas leakage sensor breakers
 - Alarm equipment
 - Various safety devices, etc.
 - (iii) SHARP devices shall not be used for or in connection with equipment that requires an extremely high level of reliability and safety such as:
 - Space applications
 - Telecommunication equipment [trunk lines]
 - Nuclear power control equipment
 - Medical and other life support equipment (e.g., scuba).
- Contact a SHARP representative in advance when intending to use SHARP devices for any "specific" applications other than those recommended by SHARP or when it is unclear which category mentioned above controls the intended use.
- If the SHARP devices listed in this publication fall within the scope of strategic products described in the Foreign Exchange and Foreign Trade Control Law of Japan, it is necessary to obtain approval to export such SHARP devices.
- This publication is the proprietary product of SHARP and is copyrighted, with all rights reserved. Under the copyright laws, no part of this publication may be reproduced or transmitted in any form or by any means, electronic or mechanical, for any purpose, in whole or in part, without the express written permission of SHARP. Express written permission is also required before any use of this publication may be made by a third party.
- Contact and consult with a SHARP representative if there are any questions about the contents of this publication.