

## HIGH ISOLATION VOLTAGE HIGH COLLECTOR TO EMITTER VOLTAGE SOP PHOTOCOUPLER

PS2732-1, -2, -4  
PS2733-1, -2, -4

### FEATURES

- **HIGH ISOLATION VOLTAGE**  
BV: 2.5 k Vr.m.s. MIN
- **HIGH COLLECTOR TO EMITTER VOLTAGE**  
V<sub>CEO</sub>: 300 V MIN: PS2732-1,-2,-4  
V<sub>CEO</sub>: 350 V MIN: PS2733-1,-2,-4
- **SOP (SMALL OUT-LINE PACKAGE)**
- **ULTRA HIGH CURRENT TRANSFER RATIO**  
CTR: 4000% TYP
- **TAPING PRODUCT NUMBER (Only -1 Type)**  
PS2732-1-E3, F3  
PS2733-1-E3, F3

### DESCRIPTION

The PS2732 and PS2733 are optically coupled isolators containing a GaAs light emitting diode and an NPN silicon Darlington-connected phototransistor. Each is mounted in a plastic SOP (Small Out-line Package) for high density applications.

### APPLICATIONS

Interface circuit for various instrumentations and control equipment.

- **REPLACEMENT FOR RELAY IN PULSE-DIAL CIRCUIT**
- **HIGH CTR CIRCUIT APPLICATIONS**

### ELECTRICAL CHARACTERISTICS (T<sub>A</sub> = 25°C)

PART NUMBER			PS2732-1, -2, -4, PS2733-1, -2, -4			
	SYMBOLS	PARAMETERS	UNITS	MIN	TYP	MAX
Diode	V <sub>F</sub>	Forward Voltage, I <sub>F</sub> = 10 mA	V		1.15	1.4
	I <sub>R</sub>	Reverse Current, V <sub>R</sub> = 5 V	μA			5
	C <sub>t</sub>	Junction Capacitance, V = 0, f = 1.0 MHz	pF		30	
Transistor	I <sub>CEO</sub>	Collector to Emitter Dark Current, V <sub>CE</sub> = 300 V, I <sub>F</sub> = 0	nA			400
Coupled	CTR	Current Transfer Ratio, I <sub>F</sub> = 1 mA, V <sub>CE</sub> = 2 V	%	1500	4000	
	V <sub>CE(sat)</sub>	Collector Saturation Voltage, I <sub>F</sub> = 1 mA, I <sub>C</sub> = 2 mA	V			1.0
	R <sub>1-2</sub>	Isolation Resistance, V <sub>IN-OUT</sub> = 1.0 k VDC	Ω	10 <sup>11</sup>		
	C <sub>1-2</sub>	Isolation Capacitance, V = 0, f = 1.0 MHz	pF		0.4	
	t <sub>r</sub>	Rise Time <sup>1</sup> , V <sub>CC</sub> = 5 V, I <sub>C</sub> = 10 mA, R <sub>L</sub> = 100 Ω	μs		100	
	t <sub>f</sub>	Fall Time <sup>1</sup> , V <sub>CC</sub> = 5 V, I <sub>C</sub> = 10 mA, R <sub>L</sub> = 100 Ω	μs		100	

Note:

1. Test Circuit for Switching Time

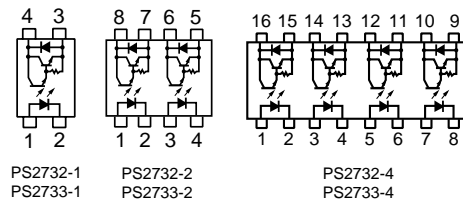
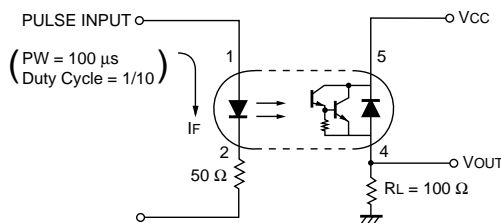

**ABSOLUTE MAXIMUM RATINGS<sup>1</sup>** (T<sub>A</sub> = 25°C)

SYMBOLS	PARAMETERS	UNITS	RATINGS	
			PS2732-1 PS2733-1	PS2732-2,-4 PS2733-2,-4
Diode				
V <sub>R</sub>	Reverse Voltage	V	6	6
I <sub>F</sub>	Forward Current	mA	50	50
P <sub>D</sub>	Power Dissipation	mW/Ch	80	80
I <sub>F</sub> (PEAK)	Peak Forward Current (P <sub>W</sub> = 100 μs, Duty Cycle 1%)	A	1	1
Transistor				
V <sub>CEO</sub>	Collector to Emitter Voltage (I <sub>C</sub> = 1mA, I <sub>B</sub> = 0)	V	300/350	300/350
V <sub>EBO</sub>	Emitter to Base Breakdown Volt (I <sub>E</sub> = 100μA, I <sub>B</sub> = 0)	V	6	6
I <sub>C</sub>	Collector Current	mA/Ch	150	150
P <sub>C</sub>	Power Dissipation	mW/Ch	150	120
Coupled				
BV	Isolation Voltage <sup>2</sup>	V <sub>r.m.s.</sub>	2500	
T <sub>OP</sub>	Operating Temperature	°C	-55 to +100	
T <sub>STG</sub>	Storage Temperature	°C	-55 to +150	

Notes:

1. Operation in excess of any one of these parameters may result in permanent damage.
2. AC voltage for 1 minute at T<sub>A</sub> = 25 °C, RH = 60 % between input and output.

**TYPICAL PERFORMANCE CURVES** (T<sub>A</sub> = 25 °C)

**DIODE POWER DISSIPATION vs. AMBIENT TEMPERATURE**

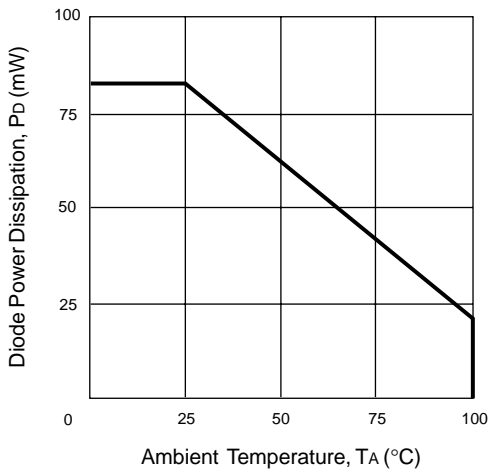

**TRANSISTOR POWER DISSIPATION vs. AMBIENT TEMPERATURE**

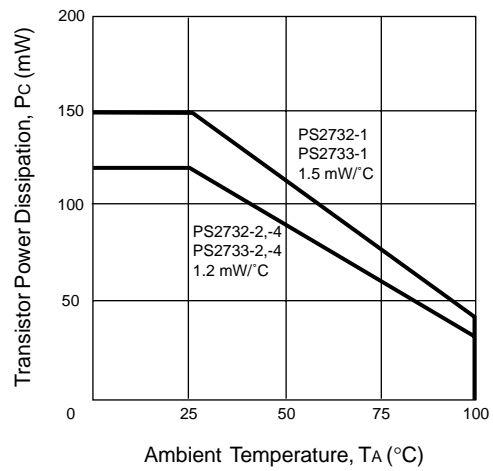

**FORWARD CURRENT vs. FORWARD VOLTAGE**

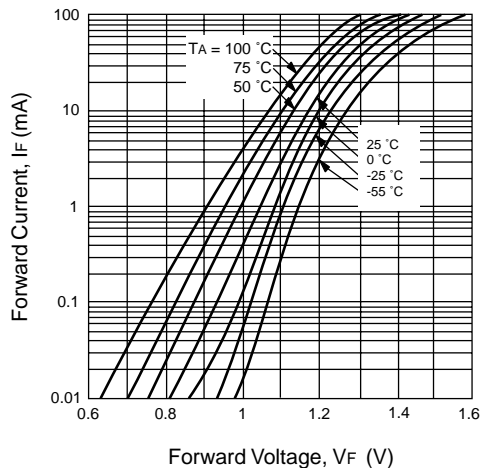

**COLLECTOR CURRENT vs. COLLECTOR TO EMITTER VOLTAGE**

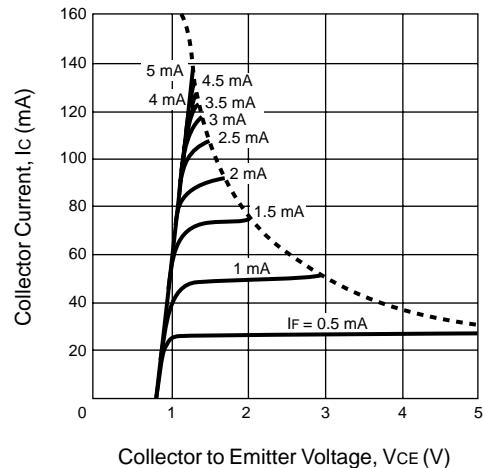

**TYPICAL PERFORMANCE CURVES** ( $T_A = 25^\circ\text{C}$ )

**COLLECTOR TO EMITTER DARK CURRENT vs. AMBIENT TEMPERATURE**

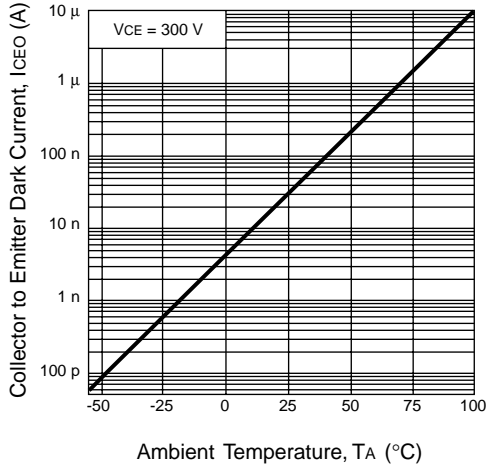

**COLLECTOR CURRENT vs. COLLECTOR SATURATION VOLTAGE**

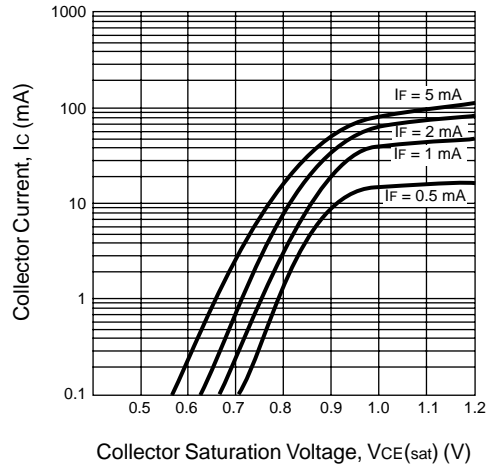

**NORMALIZED OUTPUT CURRENT vs. AMBIENT TEMPERATURE**

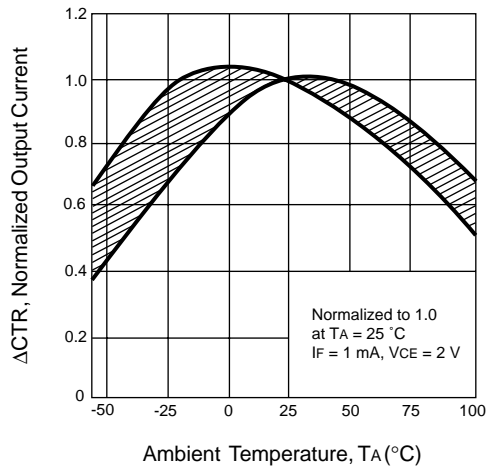

**CURRENT TRANSFER RATIO (CTR) vs. FORWARD CURRENT**

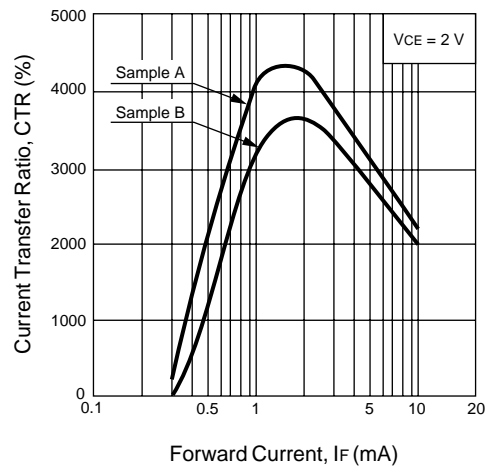

**SWITCHING TIME vs. LOAD RESISTANCE**

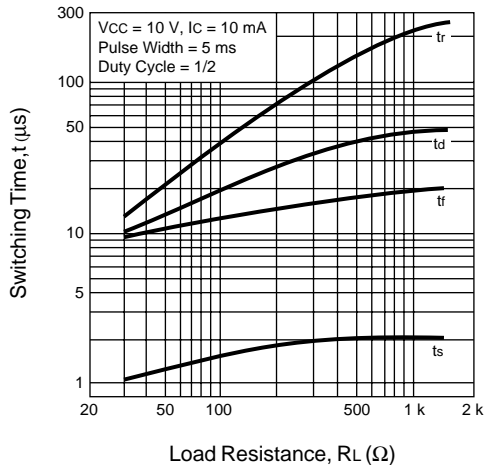

**FREQUENCY RESPONSE**

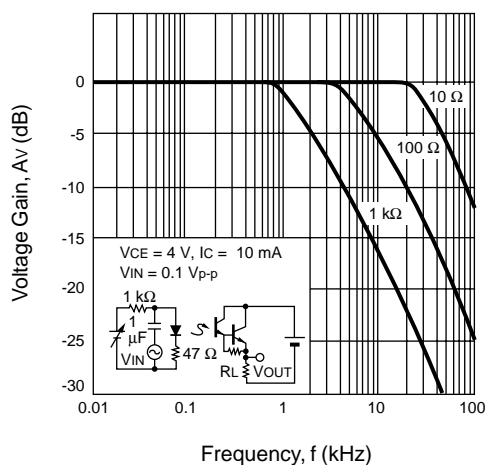

**TYPICAL PERFORMANCE CURVES** (T<sub>A</sub> = 25 °C)

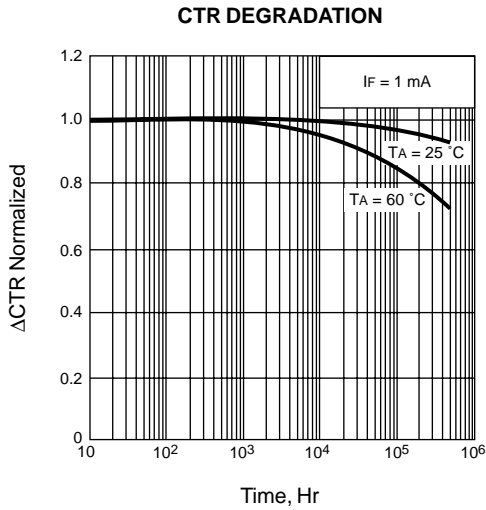

**OUTLINE DIMENSIONS** (Units in mm)

**PS2732-1, PS2733-1**

**PIN CONNECTION**  
(Top View)

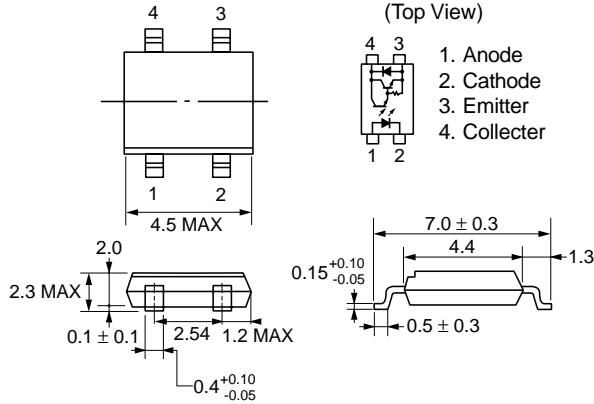

**PS2732-2, PS2733-2**

**PIN CONNECTION**  
(Top View)

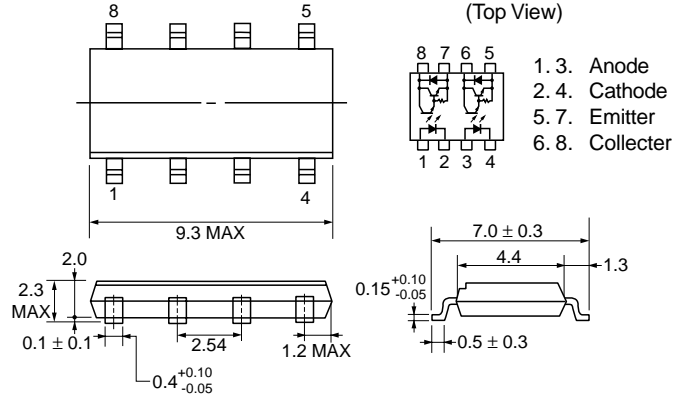

**PS2732-4, PS2733-4**

**PIN CONNECTION**  
(Top View)

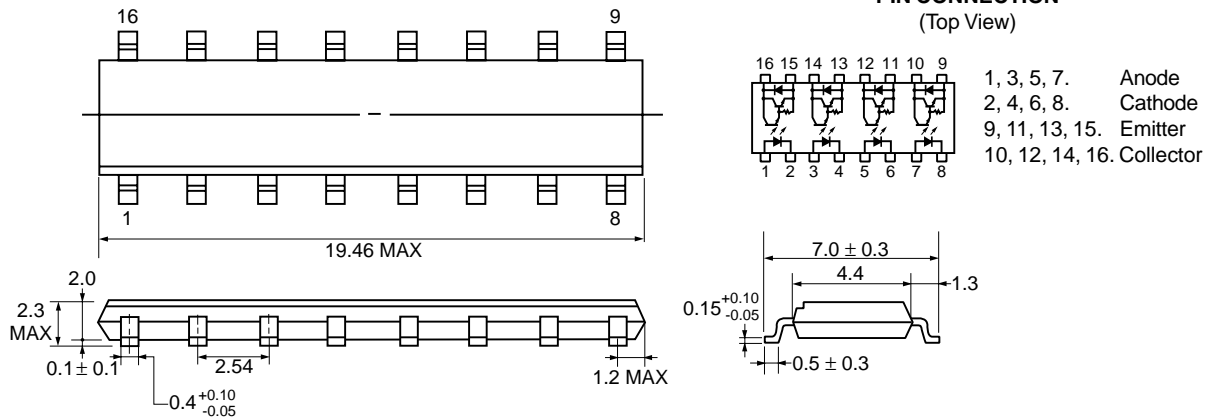

EXCLUSIVE NORTH AMERICAN AGENT FOR **NEC** RF, MICROWAVE & OPTOELECTRONIC SEMICONDUCTORS

**CEL CALIFORNIA EASTERN LABORATORIES** • Headquarters • 4590 Patrick Henry Drive • Santa Clara, CA 95054-1817 • (408) 988-3500 • Telex 34-6393 • FAX (408) 988-0279  
24-Hour Fax-On-Demand: 800-390-3232 (U.S. and Canada only) • Internet: <http://WWW.CEL.COM>

DATA SUBJECT TO CHANGE WITHOUT NOTICE

7/26/2000