

FEATURES

- **2 CHANNEL TYPE:**
OCMOS FET + PHOTOCOUPLER
- **DESIGNED FOR AC/DC SWITCHING LINE CHANGER**
- **SMALL PACKAGE:**
8-PIN SOP
- **ISOLATION VOLTAGE:**
BV: 1500 Vr.m.s. MIN
- **LOW OFFSET VOLTAGE**
- **LOW LED OPERATING CURRENT:**
IF = 2 mA
- **AVAILABLE IN TAPE AND REEL**

DESCRIPTION

PS7241-AT1 and PS7241-AT5 are solid state relays containing a GaAs LED on the emitting side (input side) and MOSFETs (+ Phototransistor) on the output side. They are suitable for analog signal control because of their low offset and high linearity.

APPLICATIONS

- EXCHANGE EQUIPMENT
- MEASUREMENT EQUIPMENT
- FA/OA EQUIPMENT

ELECTRICAL CHARACTERISTICS (TA = 25°C)

		PART NUMBER				PS7241-AT1, PS7241-AT5		
		SYMBOLS	PARAMETERS	CONDITIONS	UNITS	MIN	TYP	MAX
OCMOS FET	Diode	V _F	Forward Voltage	I _F = 5 mA	V		1.2	1.4
		I _R	Reverse Current	V _R = 5 V	μA			5.0
	MOSFET	I _{LOFF}	Off-state Leakage Current	V _D = 400 V	μA		0.03	1.0
		C _{out}	Output Capacitance	V _D = 0 V, f = 1 MHz	pF		65	
	Coupler	I _{Fon}	LED On-state Current	I _L = 120 mA	mA			2.0
		R _{ON1}	On-state Resistance	I _F = 10 mA, I _L = 10 mA	Ω		20	30
				I _F = 10 mA, I _L = 120 mA, t _≤ 10 ms	Ω			25
		t _{ON}	Turn-on Time	I _F = 10 mA, V _O = 5 V, PW ≥10 ms	ms		0.3	1.0
		t _{OFF}	Turn-off Time		ms		0.04	0.2
		R _{I-O}	Isolation Resistance	V _{I-O} = 1.0 kV	Ω	10 ⁹		
C _{I-O}	Isolation Capacitance	V = 0 V, f = 1 MHz	pF		1.1			
Photocoupler	Diode	V _F	Forward Voltage	I _F = 10 mA	V		1.2	1.4
		I _R	Reverse Current ¹	V _R = 5 V	μA			5.0
	Transistor	I _{CEO}	Collector to Emitter Dark Current	V _{CE} = 40 V, I _F = 0 mA	nA			100
		BV _{CEO}	Collector to Emitter Breakdown Voltage	I _C = 1 mA	V	40		
	Coupler	BV _{ECO}	Emitter to Collector Breakdown Voltage	I _E = 100 μA	V	6		
		CTR	Current Transfer Ratio	I _F = 5 mA, V _{CE} = 5 V	%	50		400
		V _{CE(sat)}	Collector Saturation Voltage	I _F = 10 mA, I _C = 2 mA	V			0.3
		R _{I-O}	Isolation Resistance	V _{in-out} = 1.0 kVcc	Ω	10 ¹¹		
		C _{I-O}	Isolation Capacitance	V = 0 V, f = 1 MHz	pF		0.4	
		t _R	Rise Time	V _{CC} = 5 V, I _C = 2 mA	μs		3.0	
t _F	Fall Time	R _L = 100 Ω	μs		5.0			

Note:

1. PS7241-AT1 only.

ABSOLUTE MAXIMUM RATINGS¹ (TA = 25°C)

	SYMBOLS	PARAMETERS	UNITS	RATINGS
OCMOS	Diode			
	IF	Forward Current (DC)	mA	50
	VR	Reverse Voltage	V	5.0
	PD	Power Dissipation	mW/ch	50
	IFP	Peak Forward Current ²	A	1.0
	MOSFET			
	VL	Break Down Voltage	V	400
	IL	Continuous Load Current	mA	120
	ILP	Pulse Load Current ³ (AC/DC Connection)	mA	250
	PD	Power Dissipation	mW	430
Photocoupler	Diode			
	IF	Forward Current	mA	50
	VR	Reverse Voltage ⁴	V	5.0
	PD	Power Dissipation	mW/ch	50
	IFP	Peak Forward Current ²	A	1.0
	Transistor			
	VCEO	Collector to Emitter Voltage	V	40
	VECO	Emitter to Collector Voltage	V	6.0
	IC	Collector Current	mA	80
	PC	Power Dissipation	mW	100
BV	Isolation Voltage ⁵	Vr.m.s.	1500	
PT	Total Power Dissipation	mW	630	
TA	Operating Ambient Temp.	°C	-40 to 80	
TSTG	Storage Temperature	°C	-40 to 100	

RECOMMENDED OPERATING CONDITIONS (TA = 25°C)

SYMBOLS	PARAMETERS	UNITS	MIN	TYP	MAX
OCMOS FET					
IF	LED Operating Current	mA	2	10	20
VF	LED Off Voltage	V	0		0.5

ORDERING INFORMATION

PART NUMBER	PACKAGE	PACKING STYLE
PS7241-AT1	8-pin SOP	Magazine case 45 pcs
PS7241-AT1-F3		Embossed Tape 1500 pcs/reel
PS7241-AT1-F4		
PS7241-AT5		Magazine case 45 pcs
PS7241-AT5-F3		Embossed Tape 1500 pcs/reel
PS7241-AT5-F4		

Notes:

1. Operation in excess of any one of these parameters may result in permanent damage.
2. PW = 100 μs, Duty Cycle = 1%.
3. PW = 100 ms, 1 shot.
4. PS7241-AT1 only.
5. AC voltage for 1 minute at TA = 25 °C, RH = 60 % between input and output.

OUTLINE DIMENSIONS (Units in mm)

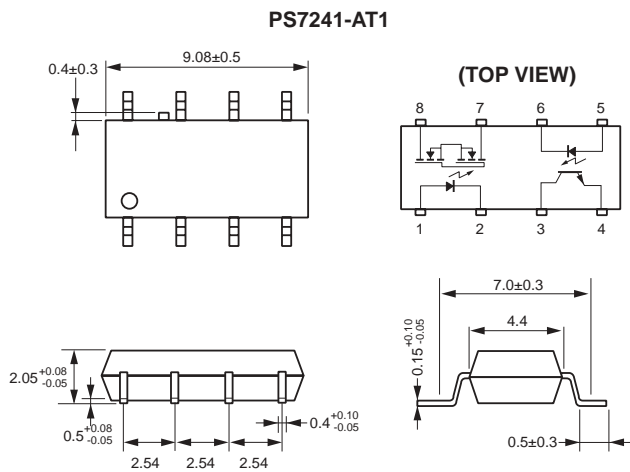

- 1 LED Anode
- 2 LED Cathode
- 3 Tr Collector
- 4 Tr Emitter
- 5 LED Anode
- 6 LED Cathode
- 7 MOSFET
- 8 MOSFET

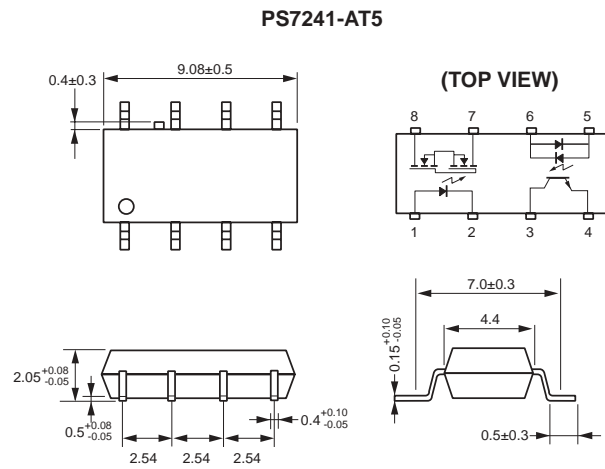

- 1 LED Anode
- 2 LED Cathode
- 3 Tr Collector
- 4 Tr Emitter
- 5 LED Anode/Cathode
- 6 LED Cathode/Anode
- 7 MOSFET
- 8 MOSFET

OCMOS TYPICAL PERFORMANCE CURVES (TA = 25°C)

MAXIMUM FORWARD CURRENT (DC)
vs. AMBIENT TEMPERATURE

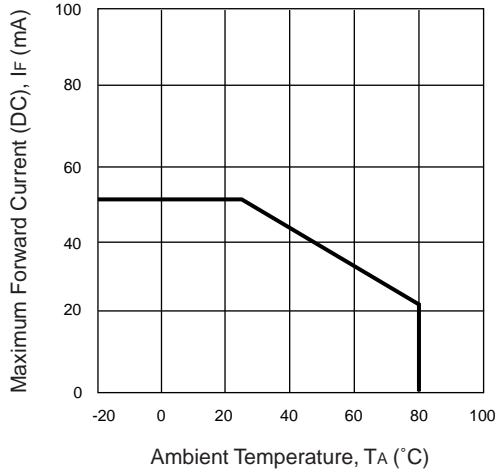

MAXIMUM LOAD CURRENT
vs. AMBIENT TEMPERATURE

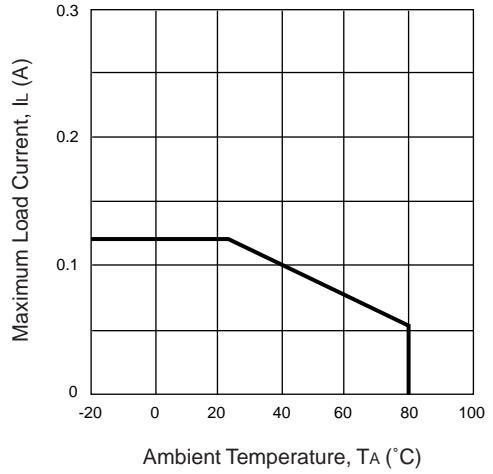

FORWARD VOLTAGE vs.
AMBIENT TEMPERATURE

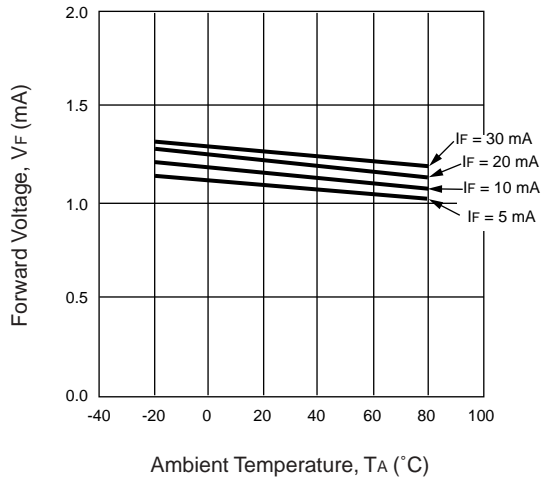

OUTPUT CAPACITANCE
vs. SUPPLY VOLTAGE

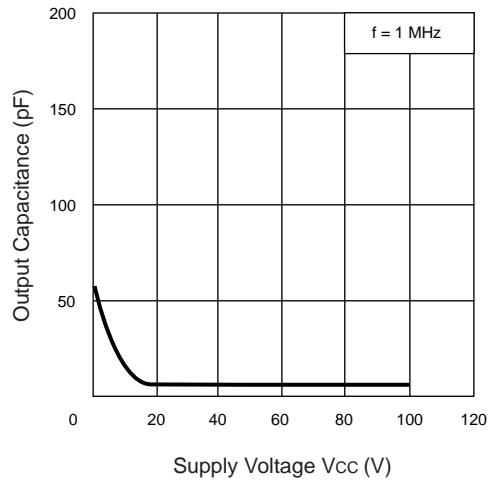

OFF-STATE LEAKAGE CURRENT
vs. SUPPLY VOLTAGE

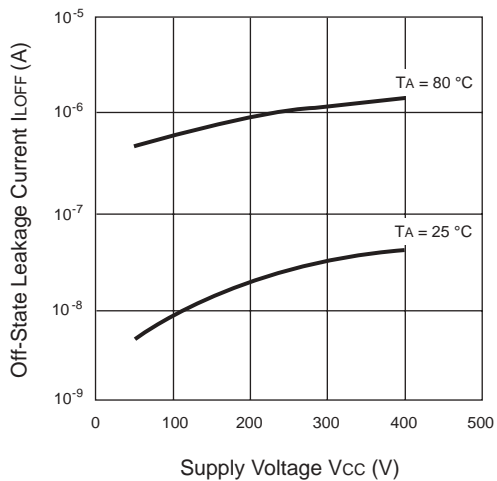

LOAD CURRENT vs.
LOAD VOLTAGE

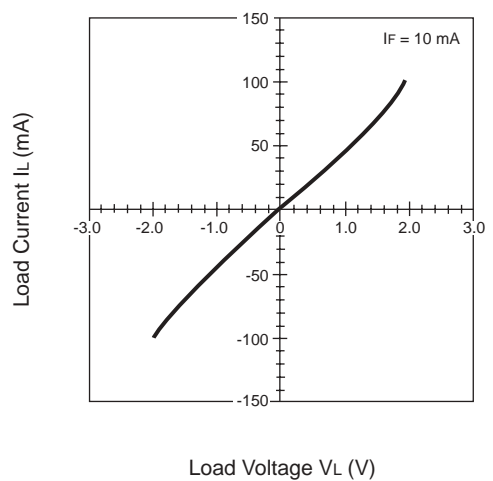

OCMOS TYPICAL PERFORMANCE CURVES (TA = 25°C)

NORMALIZED ON-STATE RESISTANCE vs. AMBIENT TEMPERATURE

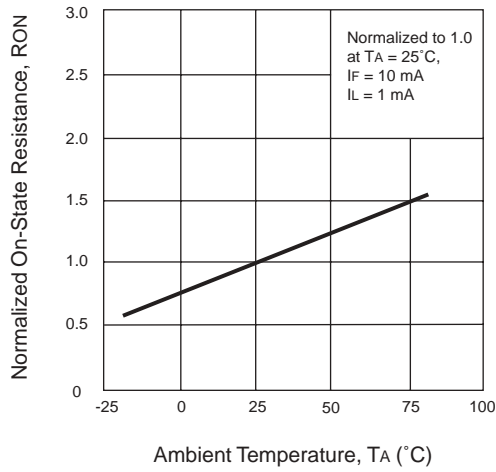

ON-STATE RESISTANCE DISTRIBUTION

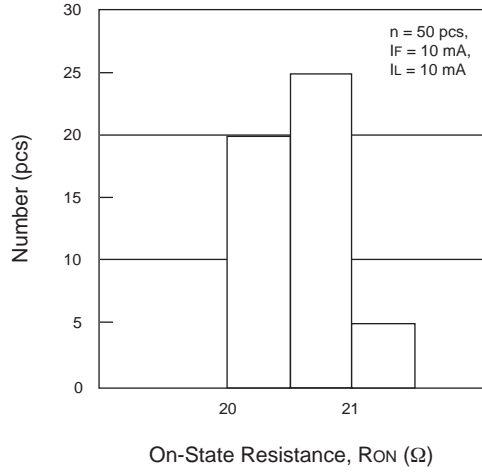

TURN-ON TIME vs. FORWARD CURRENT

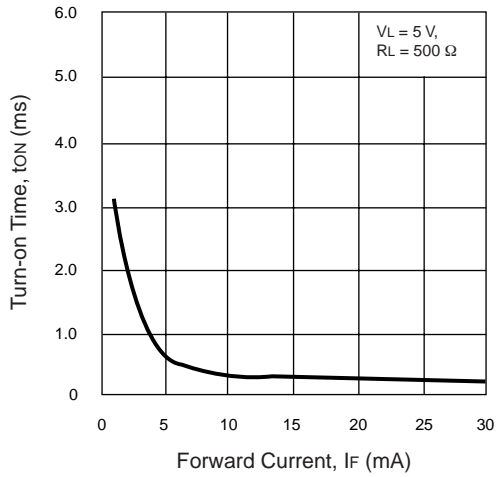

TURN-OFF TIME vs. FORWARD CURRENT

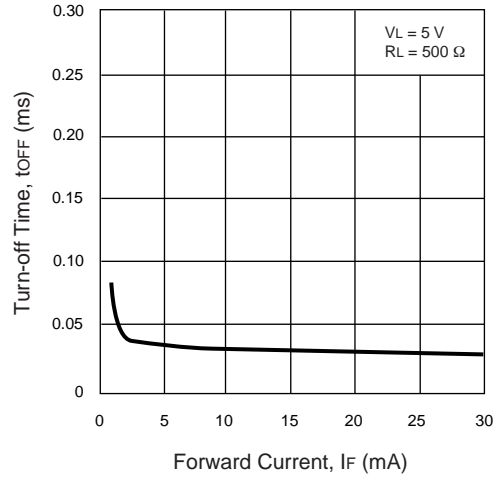

TURN-ON TIME DISTRIBUTION

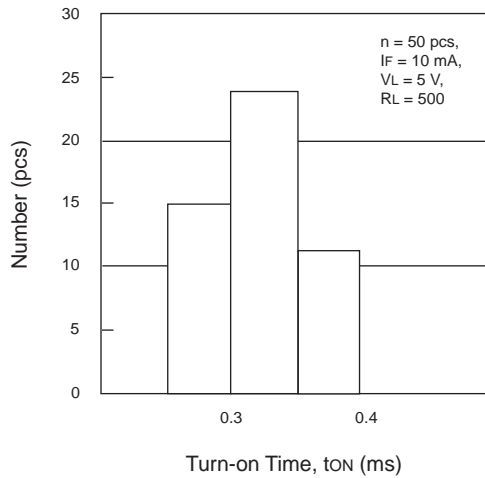

TURN-OFF TIME DISTRIBUTION

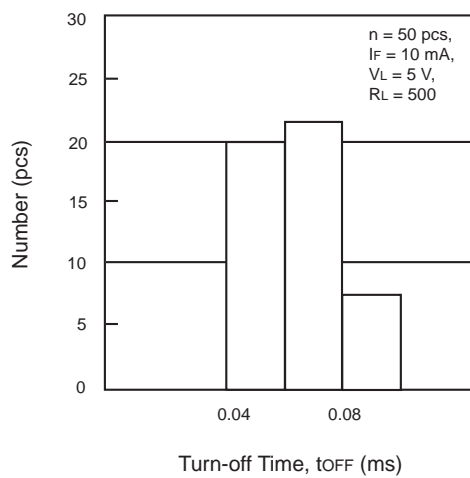

OCMOS TYPICAL PERFORMANCE CURVES (TA = 25°C)

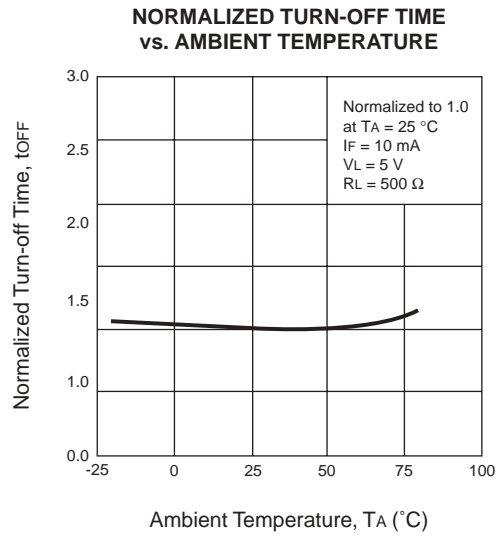
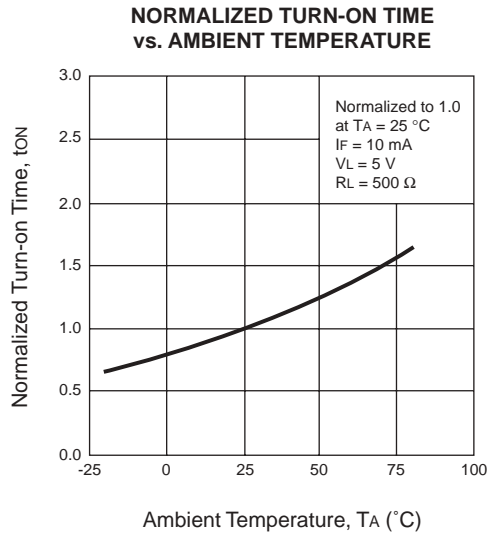

PHOTOCOUPLER TYPICAL PERFORMANCE CURVES (TA = 25°C)

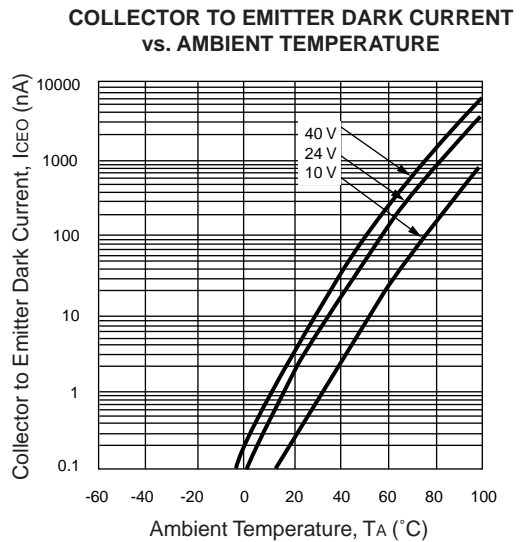
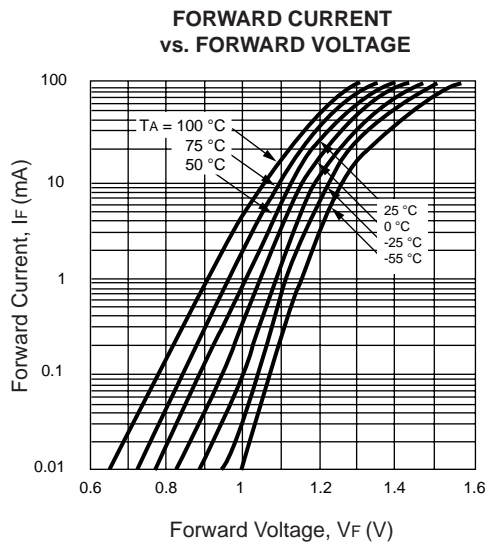
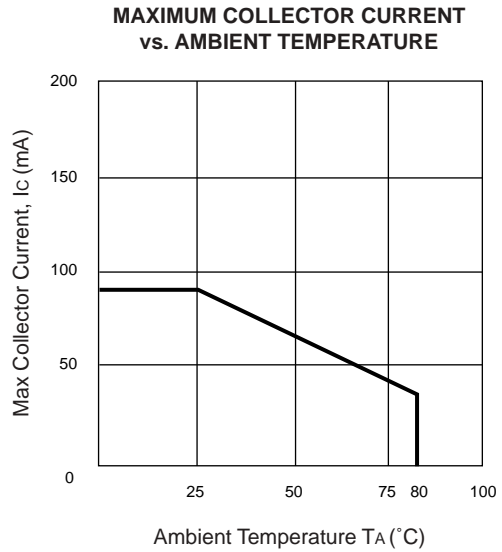
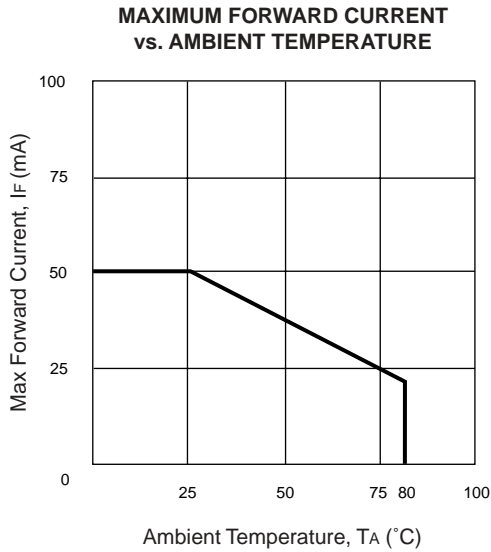

PHOTOCOUPLER TYPICAL PERFORMANCE CURVES (TA = 25°C)

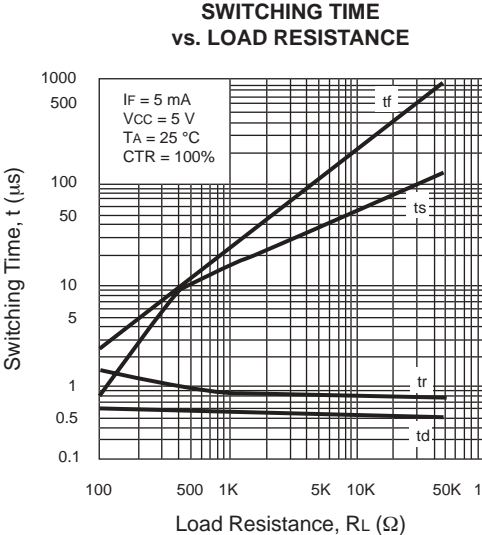
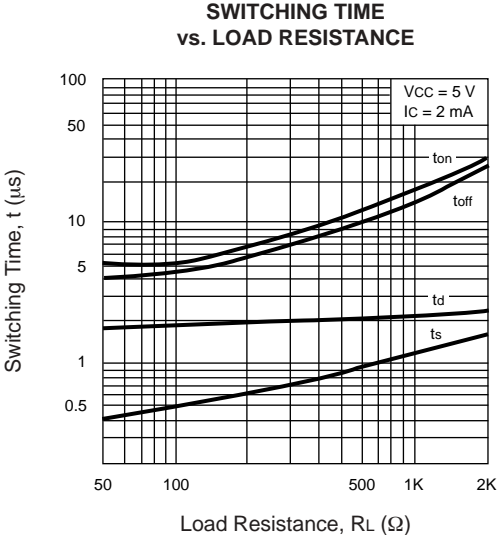
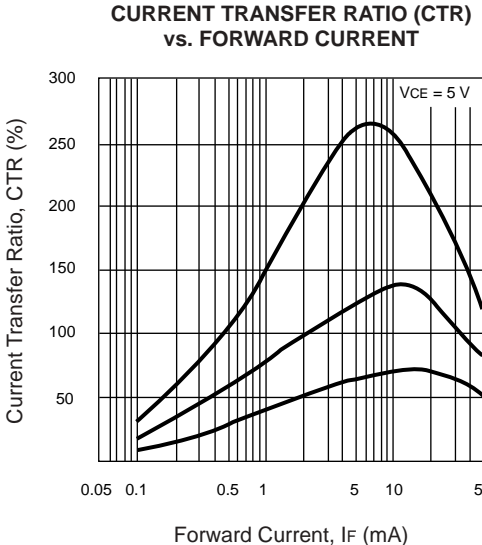
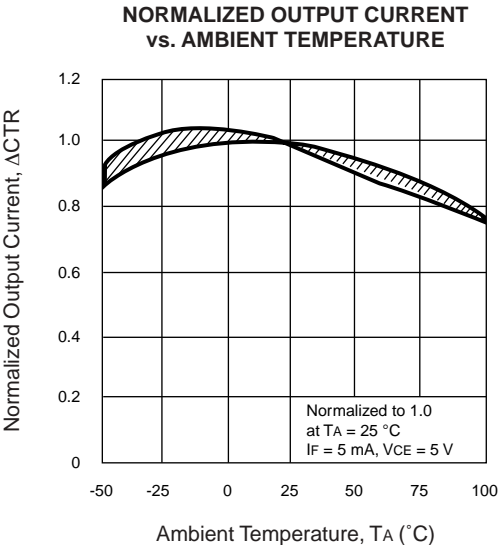
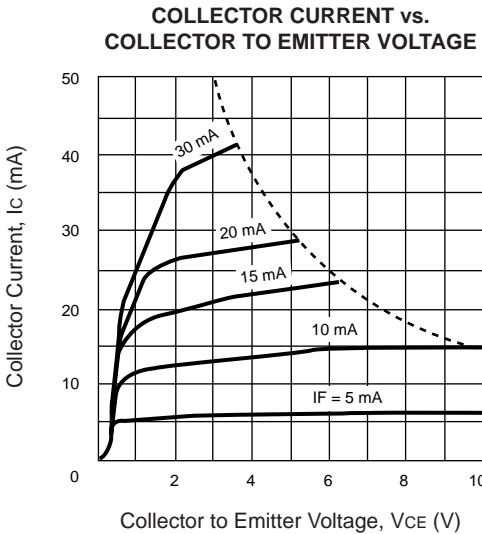
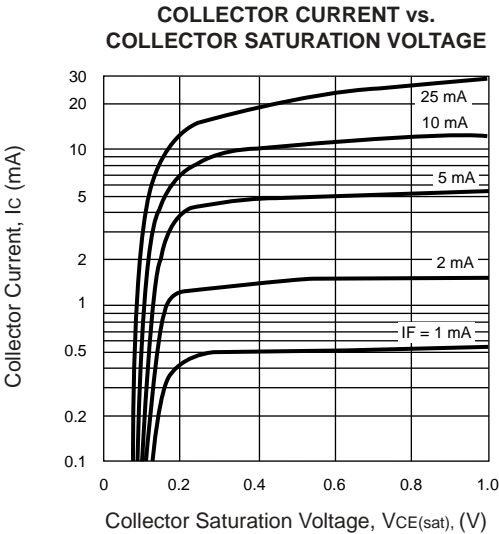

TAPING SPECIFICATIONS (Units in mm)

OUTLINE AND DIMENSIONS (TAPE)

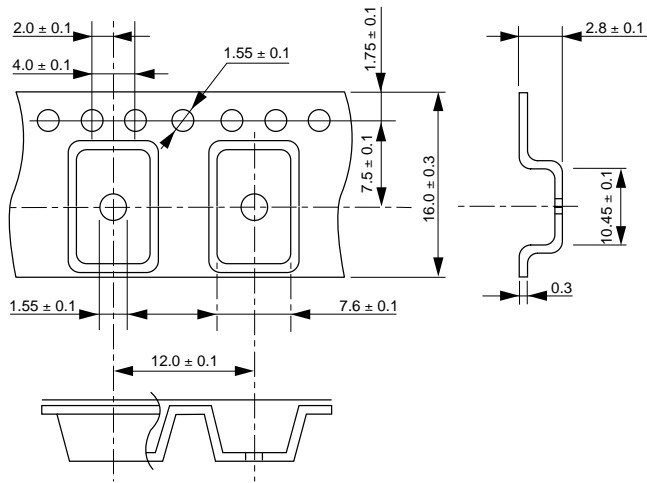

OUTLINE AND DIMENSIONS (REEL)

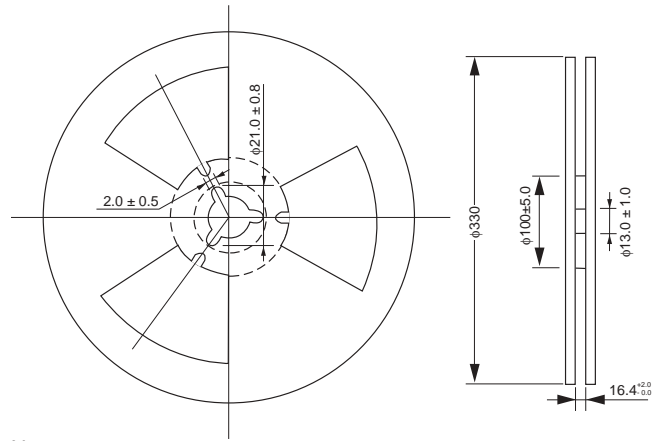

Notes:
1. Packaging : 1500 pcs/reel

TAPING DIRECTION

PS7241-AT1-F3
PS7241-AT5-F3

PS7241-AT1-F4
PS7241-AT5-F4

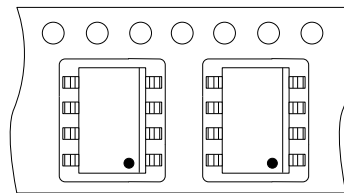
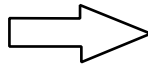
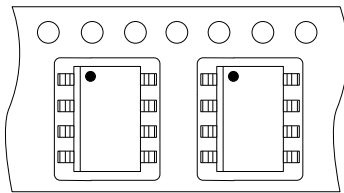

RECOMMENDED SOLDERING CONDITIONS

(1) Infrared reflow soldering

- Peak reflow temperature 235 °C or below (package surface temperature)
- Time of temperature higher than 210 °C 30 seconds or less
- Number of reflows Two
- Flux Rosin flux containing small amount of chlorine
(The flux with a maximum chlorine content of 0.2 Wt % is recommended.)

Recommended Temperature Profile of Infrared Reflow

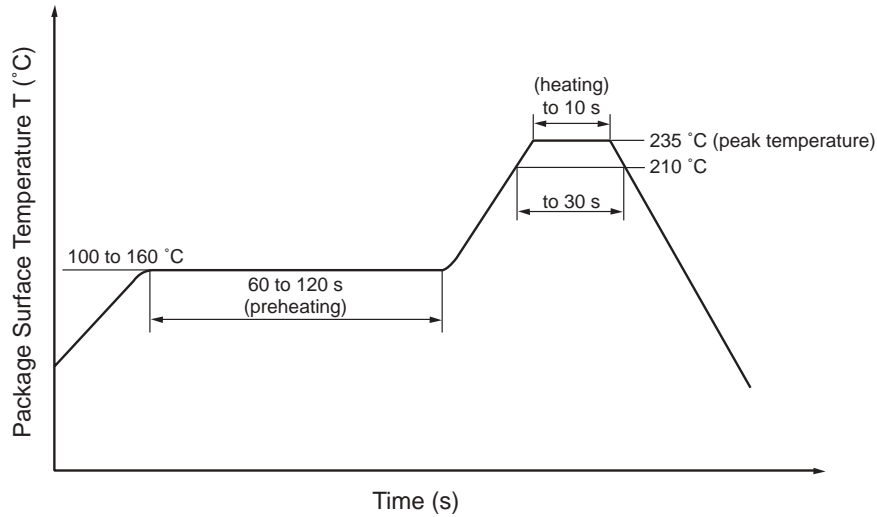

(2) Dip soldering

- Temperature 260 °C or below (molten solder temperature)
- Time 10 seconds or less
- Number of times One
- Flux Rosin flux containing small amount of chlorine
(The flux with a maximum chlorine content of 0.2 Wt % is recommended.)

(3) Cautions

- Fluxes
Avoid removing the residual flux with freon-based cleaning solvent.
- Avoid shorting between portion of frame and leads.

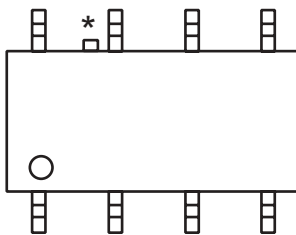

* Portion of frame

EXCLUSIVE NORTH AMERICAN AGENT FOR NEC RF, MICROWAVE & OPTOELECTRONIC SEMICONDUCTORS