

HIGH NOISE REDUCTION HIGH-SPEED ANALOG OUTPUT TYPE
5-PIN SOP PHOTOCOUPLER

DESCRIPTION

The PS8701 is an optically coupled isolator containing a GaAlAs LED on the light emitting diode (input side) and a PIN photodiode and a high-speed amplifier transistor on the output side on one chip.

This is a plastic SOP (Small Out-line Package) type for high density applications.

FEATURES

- High common mode transient immunity ($C_{MH}, C_{ML} = \pm 10 \text{ kV}/\mu\text{s}$ MIN.)
- High supply voltage ($V_{CC} = 35 \text{ V}$)
- High isolation voltage ($BV = 2\,500 \text{ Vr.m.s.}$)
- High-speed response ($t_{PHL} = 0.8 \mu\text{s}$ MAX., $t_{PLH} = 1.2 \mu\text{s}$ MAX.)
- Taping product number (PS8701-E3, E4, F3, F4)

APPLICATIONS

- Computer and peripheral manufactures
- General purpose inverter
- Substitutions for relays and pulse transformers
- Power supply

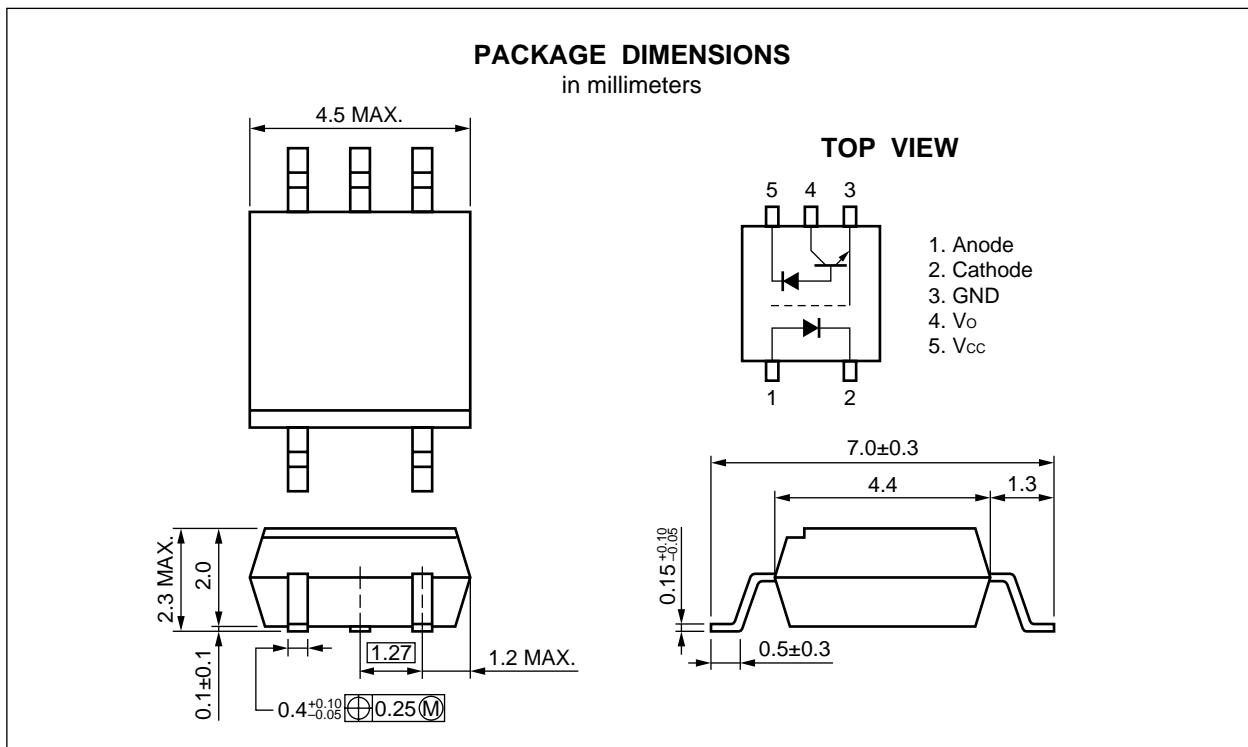

The information in this document is subject to change without notice.

ABSOLUTE MAXIMUM RATINGS (T_A = 25 °C, unless otherwise specified)

Parameter		Symbol	Ratings	Unit
Diode	Forward Current	I _F	25	mA
	Reverse Voltage	V _R	3.0	V
	Power Dissipation	P _D	45	mW
Detector	Supply Voltage	V _{CC}	35	V
	Output Voltage	V _O	35	V
	Output Current	I _O	8.0	mA
	Power Dissipation	P _C	100	mW
Isolation Voltage ^{*1}		BV	2 500	Vr.m.s.
Operating Ambient Temperature		T _A	-55 to +100	°C
Storage Temperature		T _{stg}	-55 to +125	°C

*1 AC voltage for 1 minute at T_A = 25 °C, RH = 60 % between input and output

ELECTRICAL CHARACTERISTICS (T_A = 25 °C)

Parameter		Symbol	Conditions	MIN.	TYP.	MAX.	Unit
Diode	Forward Voltage	V _F	I _F = 16 mA		1.7	2.2	V
	Reverse Current	I _R	V _R = 3 V			10	μA
	Forward Voltage Temperature Coefficient	ΔV _F /ΔT	I _F = 16 mA		-1.6		mV/°C
	Terminal Capacitance	C _t	V = 0 V, f = 1 MHz		60		pF
Detector	High Level Output Current	I _{OH} (1)	I _F = 0 mA, V _{CC} = V _O = 5.5 V		3	500	nA
	High Level Output Current	I _{OH} (2)	I _F = 0 mA, V _{CC} = V _O = 30 V			100	μA
	Low Level Output Voltage	V _{OL}	I _F = 16 mA, V _{CC} = 4.5 V, I _O = 1.2 mA		0.1	0.4	V
	Low Level Supply Current	I _{CC} L	I _F = 16 mA, V _O = open, V _{CC} = 30 V		50		μA
	High Level Supply Current	I _{CC} H	I _F = 0 mA, V _O = open, V _{CC} = 30 V		0.01	2	
Coupled	Current Transfer Ratio	CTR	I _F = 16 mA, V _{CC} = 4.5 V, V _O = 0.4 V	15	20	35	%
	Isolation Resistance	R _{I-O}	V _{I-O} = 1 kV _{DC} , RH = 40 to 60 %	10 ¹¹			Ω
	Isolation Capacitance	C _{I-O}	V = 0 V, f = 1 MHz		0.4		pF
	Propagation Delay Time (H → L) ^{*1}	t _{PHL}	I _F = 16 mA, V _{CC} = 5 V, R _L = 2.2 kΩ, C _L = 15 pF		0.5	0.8	μs
	Propagation Delay Time (L → H) ^{*1}	t _{PLH}			0.6	1.2	
	Common Mode Transient Immunity at High Level Output ^{*2}	C _{MH}	I _F = 0 mA, V _{CC} = 5 V, R _L = 4.1 kΩ, V _{CM} = 1.5 kV	10			kV/μs
	Common Mode Transient Immunity at Low Level Output ^{*2}	C _{ML}	I _F = 16 mA, V _{CC} = 5 V, R _L = 4.1 kΩ, V _{CM} = 1.5 kV	-10			

***1 Test circuit for propagation delay time**

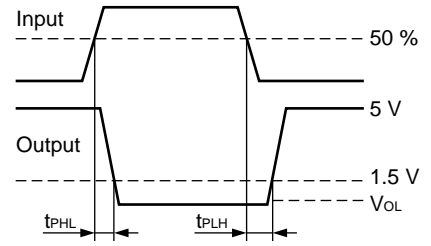
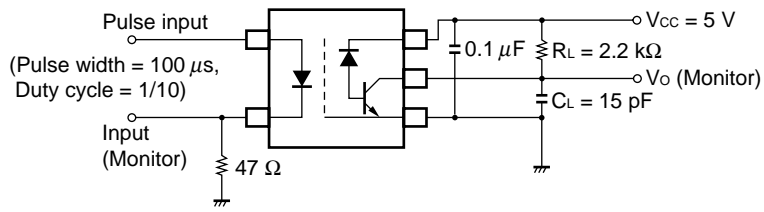

C_L is approximately 15 pF which includes probe and stray wiring capacitance

***2 Test circuit for common mode transient immunity**

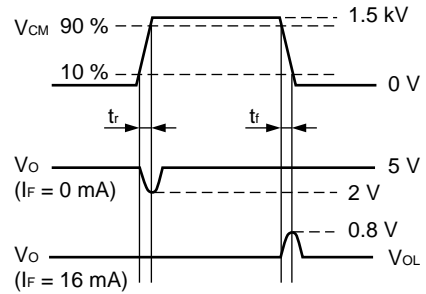
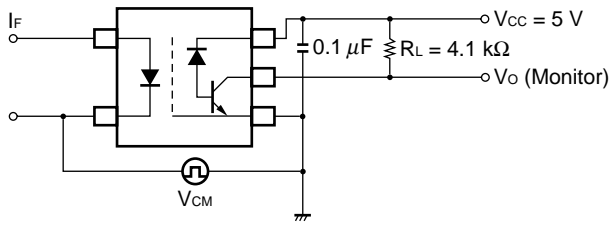

USAGE CAUTIONS

1. This product is weak for static electricity by designed with high-speed integrated circuit so protect against static electricity when handling.
2. By-pase capacitor of more than 0.1 μF is used between V_{CC} and GND near device.

TYPICAL CHARACTERISTICS ($T_A = 25\text{ }^\circ\text{C}$, unless otherwise specified)

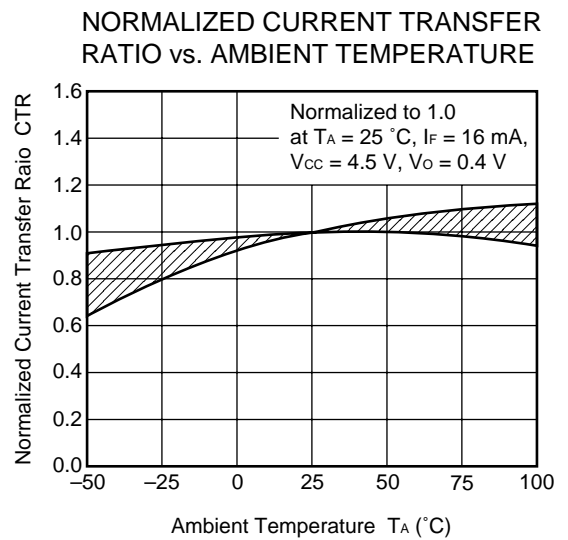
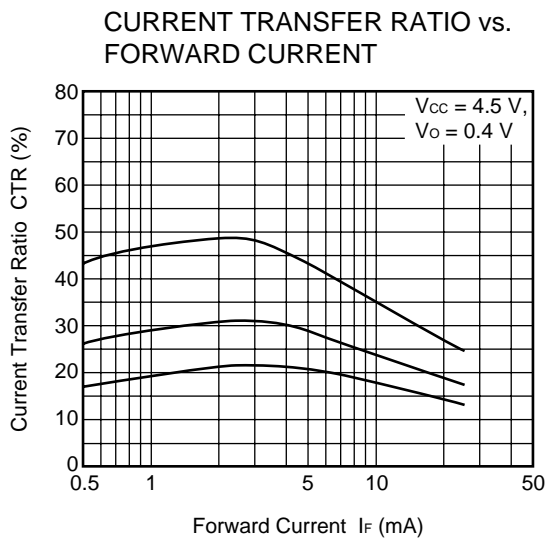
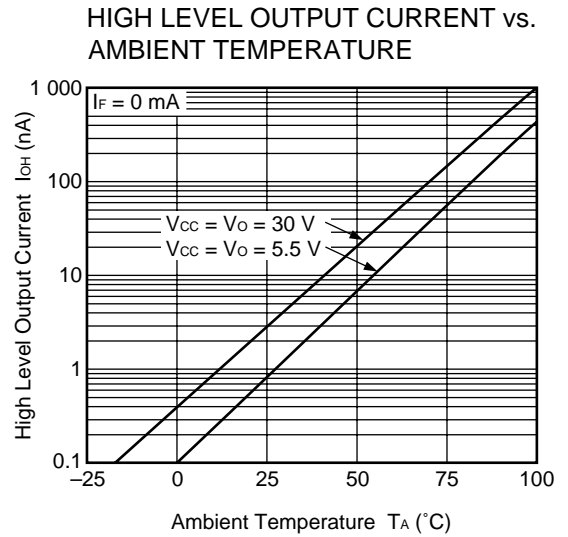
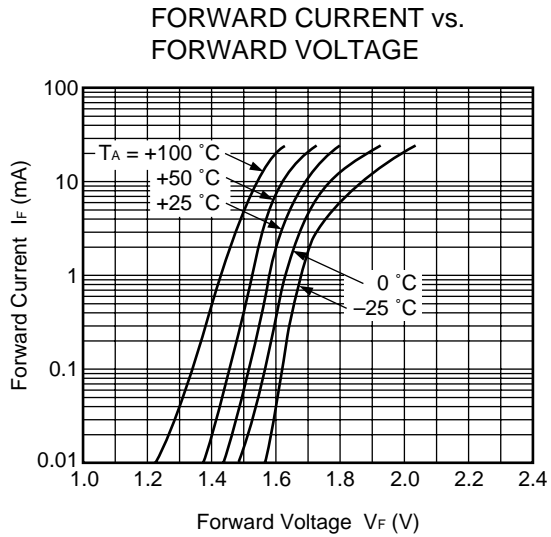
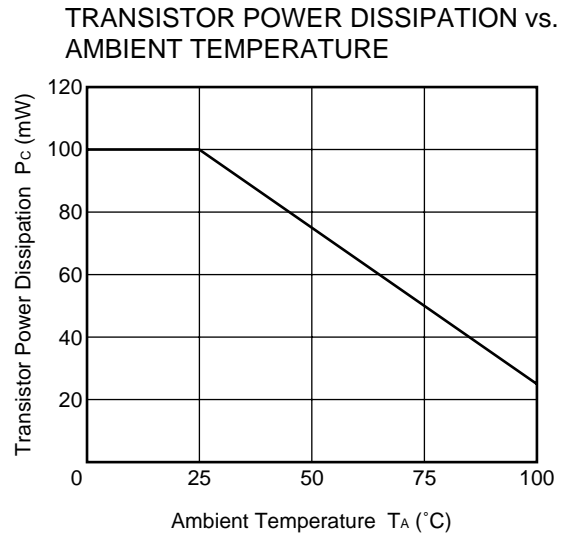
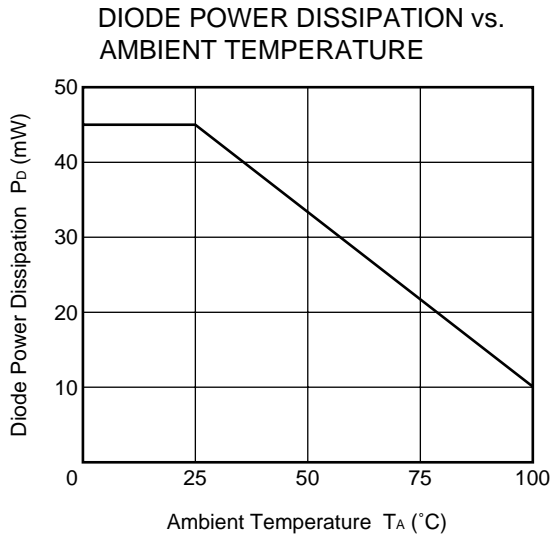

OUTPUT CURRENT vs. OUTPUT VOLTAGE

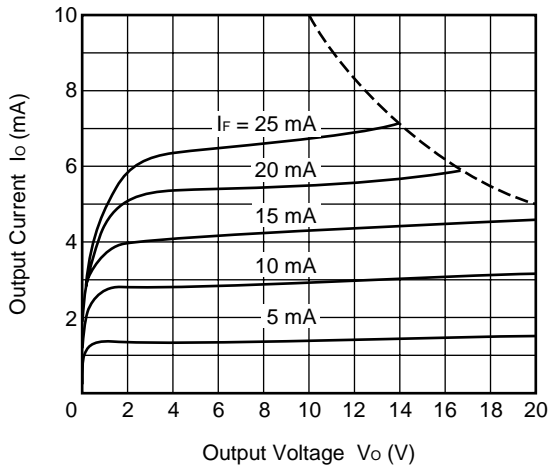

OUTPUT VOLTAGE vs. FORWARD CURRENT

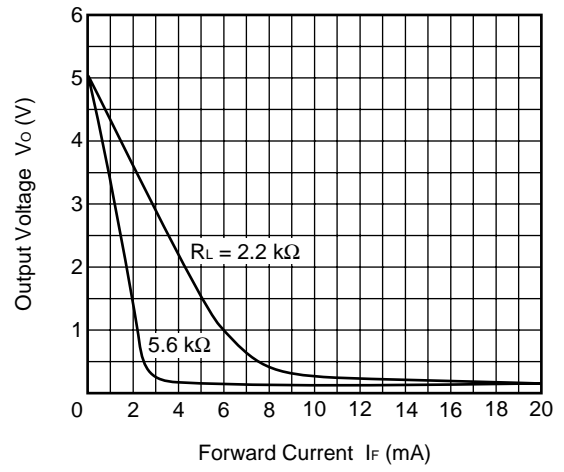

PROPAGATION DELAY TIME vs. FORWARD CURRENT

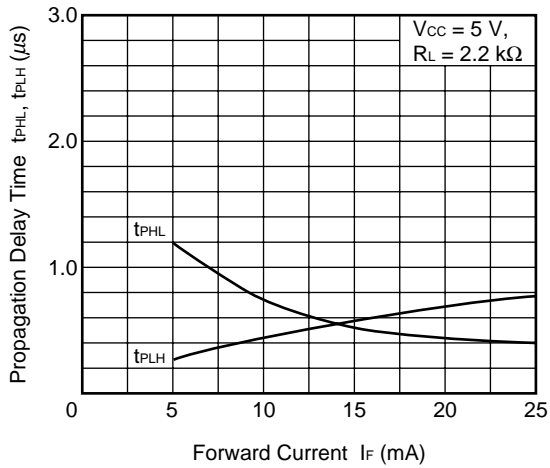

PROPAGATION DELAY TIME vs. LOAD RESISTANCE

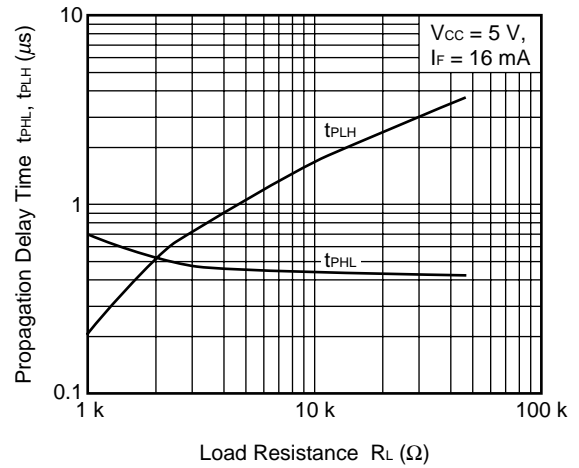

NORMALIZED PROPAGATION DELAY TIME vs. AMBIENT TEMPERATURE

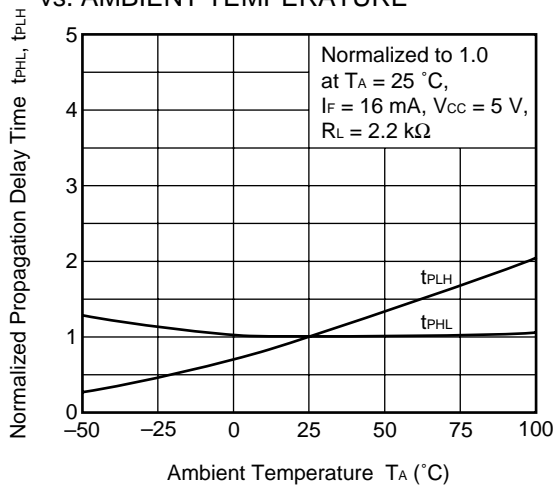

TAPING SPECIFICATIONS (in millimeters)

Outline and Dimensions (Tape)

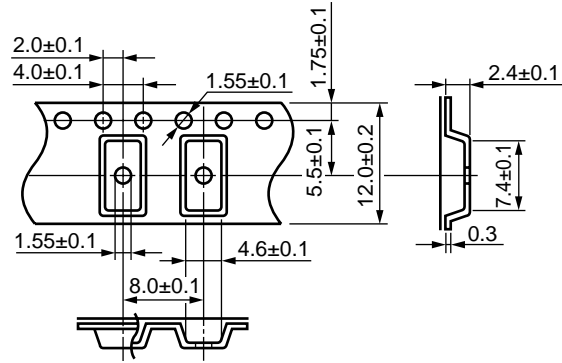

Taping Direction

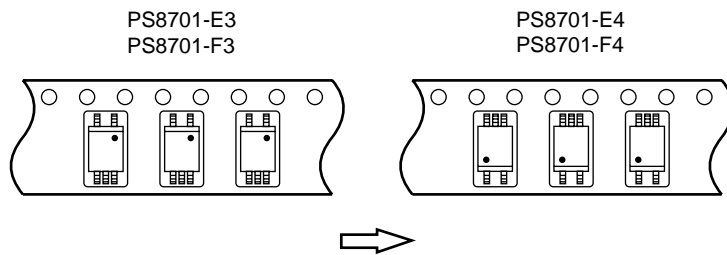

Outline and Dimensions (Reel)

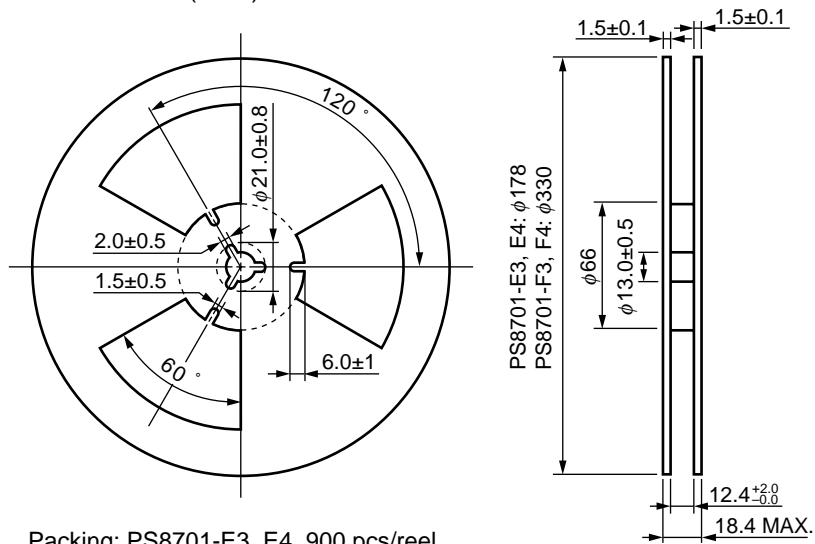

Packing: PS8701-E3, E4 900 pcs/reel
 PS8701-F3, F4 3 500 pcs/reel

RECOMMENDED SOLDERING CONDITIONS

(1) Infrared reflow soldering

- Peak reflow temperature 235 °C (package surface temperature)
- Time of temperature higher than 210 °C 30 seconds or less
- Number of reflows Three
- Flux Rosin flux containing small amount of chlorine (The flux with a maximum chlorine content of 0.2 Wt % is recommended.)

Recommended Temperature Profile of Infrared Reflow

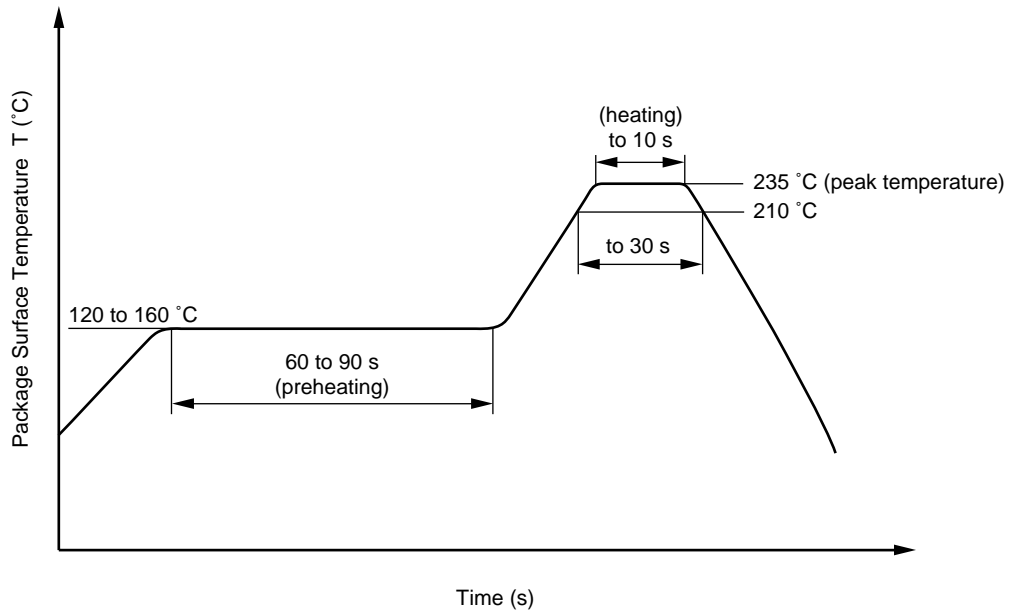

Caution Please avoid to removed the residual flux by water after the first reflow processes.

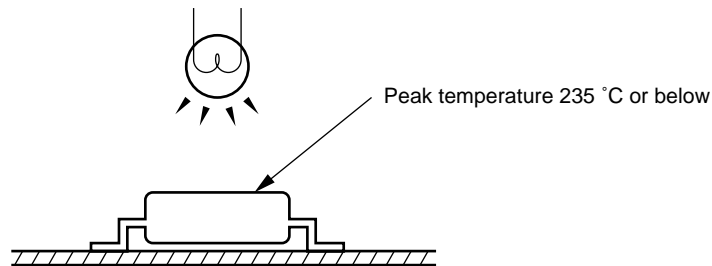

(2) Dip soldering

- Temperature 260 °C or below (molten solder temperature)
- Time 10 seconds or less
- Number of times One
- Flux Rosin flux containing small amount of chlorine (The flux with a maximum chlorine content of 0.2 Wt % is recommended.)

CAUTION

Within this device there exists GaAs (Gallium Arsenide) material which is a harmful substance if ingested. Please do not under any circumstances break the hermetic seal.

No part of this document may be copied or reproduced in any form or by any means without the prior written consent of NEC Corporation. NEC Corporation assumes no responsibility for any errors which may appear in this document.

NEC Corporation does not assume any liability for infringement of patents, copyrights or other intellectual property rights of third parties by or arising from use of a device described herein or any other liability arising from use of such device. No license, either express, implied or otherwise, is granted under any patents, copyrights or other intellectual property rights of NEC Corporation or others.

While NEC Corporation has been making continuous effort to enhance the reliability of its semiconductor devices, the possibility of defects cannot be eliminated entirely. To minimize risks of damage or injury to persons or property arising from a defect in an NEC semiconductor device, customers must incorporate sufficient safety measures in its design, such as redundancy, fire-containment, and anti-failure features.

NEC devices are classified into the following three quality grades:

"Standard", "Special", and "Specific". The Specific quality grade applies only to devices developed based on a customer designated "quality assurance program" for a specific application. The recommended applications of a device depend on its quality grade, as indicated below. Customers must check the quality grade of each device before using it in a particular application.

Standard: Computers, office equipment, communications equipment, test and measurement equipment, audio and visual equipment, home electronic appliances, machine tools, personal electronic equipment and industrial robots

Special: Transportation equipment (automobiles, trains, ships, etc.), traffic control systems, anti-disaster systems, anti-crime systems, safety equipment and medical equipment (not specifically designed for life support)

Specific: Aircrafts, aerospace equipment, submersible repeaters, nuclear reactor control systems, life support systems or medical equipment for life support, etc.

The quality grade of NEC devices is "Standard" unless otherwise specified in NEC's Data Sheets or Data Books. If customers intend to use NEC devices for applications other than those specified for Standard quality grade, they should contact an NEC sales representative in advance.

Anti-radioactive design is not implemented in this product.