

Fast Recovery Epitaxial Diode (FRED) Module

PSKD 75E

$I_{FAV} = 75 \text{ A}$
 $V_{RRM} = 200-600 \text{ V}$

Preliminary Data Sheet

V_{RSM} V	V_{RRM} V	Type
200	200	PSKD 75E/02
400	400	PSKD 75E/04
600	600	PSKD 75E/06

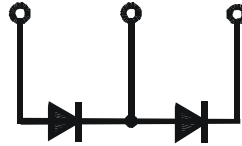

Features

- Package with screw terminals
- Isolation voltage 3000 V~
- Planar glasspassivated chips
- Short recovery time
- Low forward voltage drop
- Short recovery behaviour
- UL registered, E 148688

Applications

- Inductive heating and melting
- Free wheeling diode in converters and motor control circuits
- Uninterruptible power supplies (UPS)
- Ultrasonic cleaners and welders

Advantages

- High reliability circuit operation
- Low voltage peaks for reduced protection circuits
- Low noise switching
- Low losses

Package, style and outline

Dimensions in mm (1mm = 0.0394")

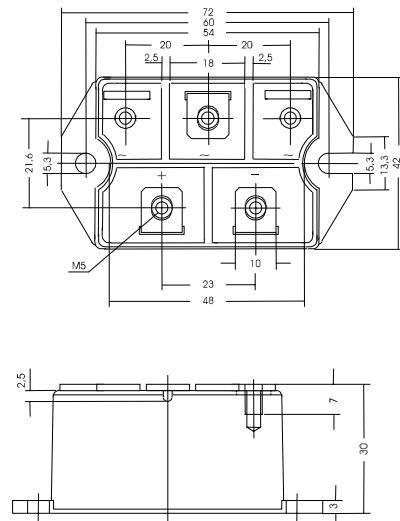

Symbol	Test Conditions	Maximum Ratings
I_{FAV}	$T_C = 85^\circ\text{C}$	75 A
I_{FSM}	$T_{VJ} = 45^\circ\text{C}$ $V_R = 0$ $t = 10 \text{ ms}$ (50 Hz), sine	1400 A
	$t = 8.3 \text{ ms}$ (60 Hz), sine	1540 A
	$T_{VJ} = T_{VJM}$ $V_R = 0$ $t = 10 \text{ ms}$ (50 Hz), sine	1250 A
	$t = 8.3 \text{ ms}$ (60 Hz), sine	1370 A
$\int i^2 dt$	$T_{VJ} = 45^\circ\text{C}$ $V_R = 0$ $t = 10 \text{ ms}$ (50 Hz), sine	9800 $\text{A}^2 \text{ s}$
	$t = 8.3 \text{ ms}$ (60 Hz), sine	9840 $\text{A}^2 \text{ s}$
	$T_{VJ} = T_{VJM}$ $V_R = 0$ $t = 10 \text{ ms}$ (50 Hz), sine	7800 $\text{A}^2 \text{ s}$
	$t = 8.3 \text{ ms}$ (60 Hz), sine	7780 $\text{A}^2 \text{ s}$
T_{VJ}		-40 ... + 150 $^\circ\text{C}$
T_{VJM}		150 $^\circ\text{C}$
T_{stg}		-40 ... + 125 $^\circ\text{C}$
V_{ISOL}	50/60 HZ, RMS $t = 1 \text{ min}$	2500 V ~
	$I_{ISOL} \leq 1 \text{ mA}$ $t = 1 \text{ s}$	3000 V ~
M_d	Mounting torque (M5)	5 Nm
	Terminal connection torque (M5)	5 Nm
Weight	typ.	160 g

Symbol	Test Conditions	Characteristic Value
I_R	$V_R = V_{RRM}$ $T_{VJ} = 25^\circ\text{C}$	$\leq 250 \mu\text{A}$
	$V_R = V_{RRM}$ $T_{VJ} = T_{VJM}$	$\leq 2.5 \text{ mA}$
V_F	$I_F = 75 \text{ A}$ $T_{VJ} = 25^\circ\text{C}$	$\leq 1.25 \text{ V}$
t_{rr}	$T_{VJ} = 25^\circ\text{C}$, $I_F = 1 \text{ A}$; $-di/dt = 100 \text{ A}/\mu\text{s}$; $V_R = 30 \text{ V}$	typ. 60 ns
V_{TO}	For power-loss calculations only	0.7 V
r_T	$T_{VJ} = T_{VJM}$	1.55 $\text{m}\Omega$
R_{thJC}	per diode; DC current	0.85 K/W
	per module	0.43 K/W
R_{thJK}	per diode; DC current	1.0 K/W
	per module	0.5 K/W
d_S	Creeping distance on surface	10 mm
d_A	Creeping distance in air	9.4 mm
a	Max. allowable acceleration	50 m/s^2