

STANDARD CAPACITANCE TVS ARRAY

APPLICATIONS

- ✓ Cellular Phones
- ✓ MP3 Players
- ✓ Personal Digital Assistant (PDA)
- ✓ Notebooks
- ✓ Digital Cameras

IEC COMPATIBILITY (EN61000-4)

- ✓ 61000-4-2 (ESD): Air - 15kV, Contact - 8kV
- ✓ 61000-4-4 (EFT): 40A - 5/50ns

FEATURES

- ✓ 100 Watts Peak Pulse Power per Line (tp=8/20µs)
- ✓ Available in Multiple Voltages
- ✓ Up to Four (4) Lines of Protection
- ✓ ESD Protection > 25 kilovolts
- ✓ Low Clamping Voltage
- ✓ RoHS Compliant in Lead-Free Versions

MECHANICAL CHARACTERISTICS

- ✓ Molded JEDEC SC-70-5L Package
- ✓ Available in Tin-Lead or Lead-Free Pure-Tin Plating(Annealed)
- ✓ Solder Reflow Temperature:
 - Tin-Lead - Sn/Pb, 85/15: 240-245°C
 - Pure-Tin - Sn, 100: 260-270°C
- ✓ Weight 7 milligrams (Approximate)
- ✓ Flammability Rating UL 94V-0
- ✓ 8mm Tape and Reel Per EIA Standard 481
- ✓ Marking: Marking Code & Pin One Defined By DOT on Package



PIN CONFIGURATIONS

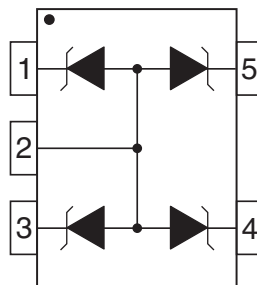

DEVICE CHARACTERISTICS

MAXIMUM RATINGS @ 25°C Unless Otherwise Specified			
PARAMETER	SYMBOL	VALUE	UNITS
Peak Pulse Power ($t_p = 8/20\mu s$) - See Figure 1	P_{PP}	100	Watts
Operating Temperature	T_J	-55°C to 150°C	°C
Storage Temperature	T_{STG}	-55°C to 150°C	°C
Forward Voltage @ 1A, 8/20μs	V_{FP}	1.5	Volts

ELECTRICAL CHARACTERISTICS PER LINE @ 25°C Unless Otherwise Specified							
PART NUMBER	DEVICE MARKING CODE	RATED STAND-OFF VOLTAGE	MINIMUM BREAKDOWN VOLTAGE (See Note 1)	MAXIMUM CLAMPING VOLTAGE (See Fig. 2)	MAXIMUM CLAMPING VOLTAGE (See Fig. 2)	MAXIMUM LEAKAGE CURRENT	MAXIMUM CAPACITANCE
		V_{WM} VOLTS	@ 1mA $V_{(BR)}$ VOLTS	@ $I_p = 1A$ V_C VOLTS	@ 8/20μs $V_C @ I_{PP}$	@ V_{WM} I_D μA	@ 0V, 1 MHz C_J pF
PSMF05	05	5.0	6.0	9.5	12.0V @ 9.0A	10	60
PSMF12	12	12.0	13.3	15.0	22.0V @ 5.0A	1	30
PSMF15	15	15.0	16.7	-	33.0V @ 3.0A	1	25
PSMF24	24	24.0	26.7	-	55.5V @ 1.8A	1	20

Note 1: Test between pins 1 to 2, 3 to 2, 4 to 2 and 5 to 2.

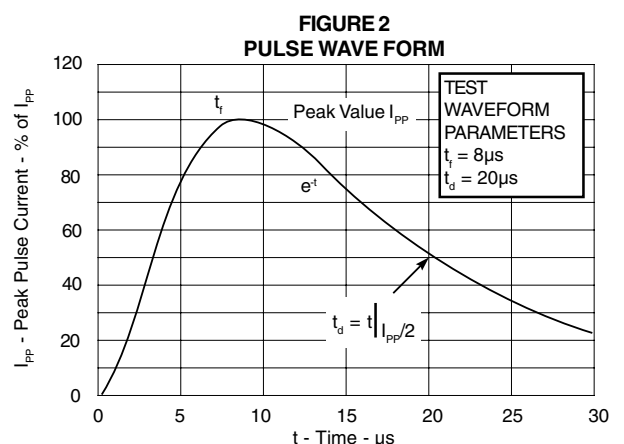
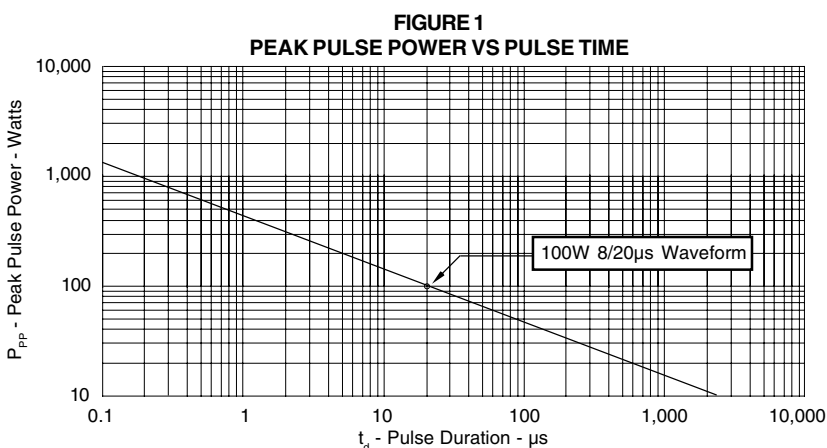

GRAPHS

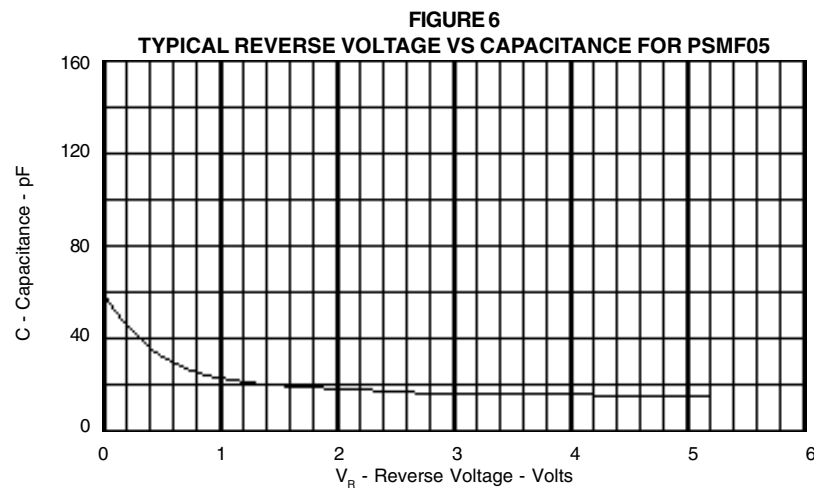
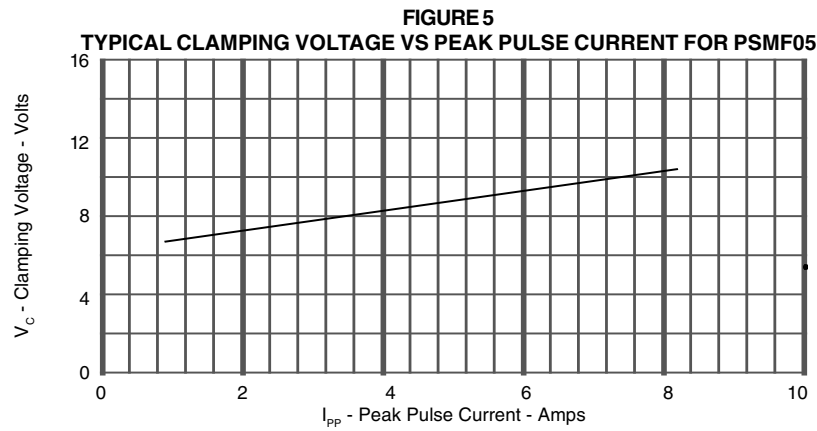
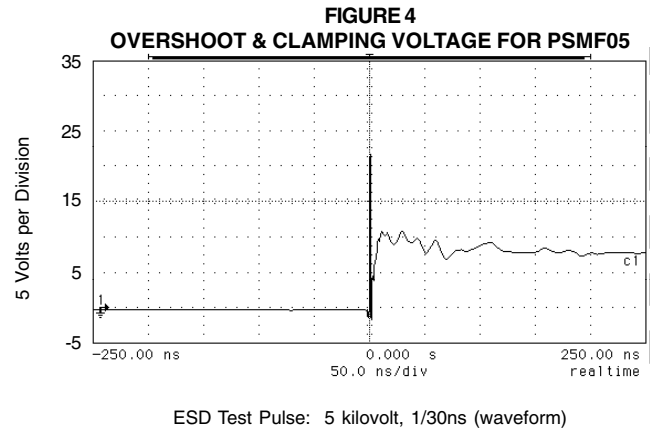
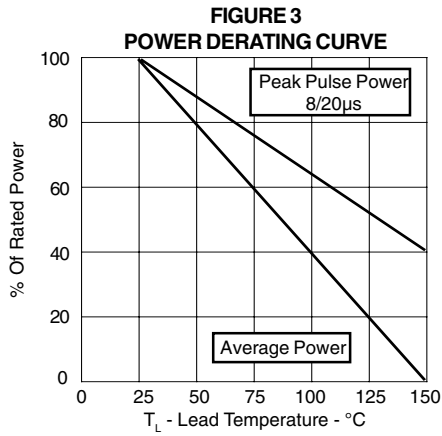

APPLICATION NOTE

The PSMF Series are TVS arrays designed to protect I/O or data lines from the damaging effects of ESD or EFT. This product provides unidirectional protection, with a surge capability of 200 Watts P_{pp} per line for an 8/20 μ s waveform and ESD protection > 25 kilovolts.

UNIDIRECTIONAL COMMON-MODE CONFIGURATION (Figure 1)

The PSMF Series provides up to four (4) lines of protection in a common-mode configuration as depicted in Figure 1. Circuit connectivity is as follows:

- ✓ I/O 1 is connected to Pin 1.
- ✓ I/O 2 is connected to Pin 3.
- ✓ I/O 3 is connected to Pin 4.
- ✓ I/O 4 is connected to Pin 5.
- ✓ Pin 2 is connected to ground.

CIRCUIT BOARD LAYOUT RECOMMENDATIONS

Circuit board layout is critical for Electromagnetic Compatibility (EMC) protection. The following guidelines are recommended:

- ✓ The protection device should be placed near the input terminals or connectors, the device will divert the transient current immediately before it can be coupled into the nearby traces.
- ✓ The path length between the TVS device and the protected line should be minimized.
- ✓ All conductive loops including power and ground loops should be minimized.
- ✓ The transient current return path to ground should be kept as short as possible to reduce parasitic inductance.
- ✓ Ground planes should be used whenever possible. For multilayer PCBs, use ground vias.

Figure 1 - Unidirectional Configuration
Common-Mode I/O Port Protection

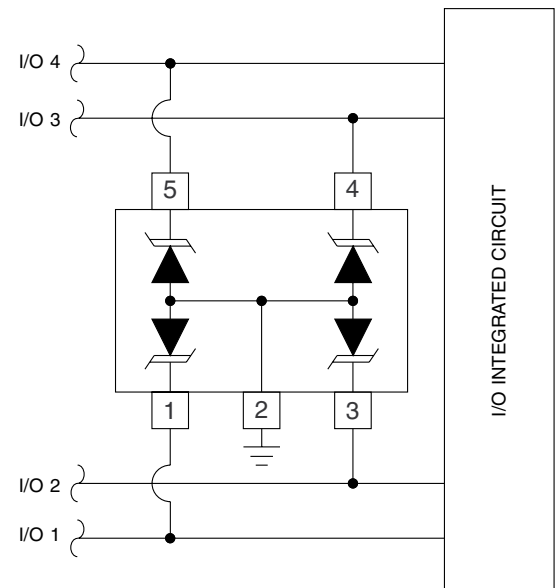

PACKAGE OUTLINE & DIMENSIONS

<p style="text-align: center;">PACKAGE OUTLINE</p>	<p style="text-align: center;">SC70-5L</p> <p style="text-align: center;">PACKAGE DIMENSIONS</p> <table border="1" style="width: 100%; border-collapse: collapse; text-align: center;"> <thead> <tr> <th rowspan="2">DIM</th> <th colspan="2">MILLIMETERS</th> <th colspan="2">INCHES</th> </tr> <tr> <th>MIN</th> <th>MAX</th> <th>MIN</th> <th>MAX</th> </tr> </thead> <tbody> <tr><td>A</td><td>1.90</td><td>2.15</td><td>0.074</td><td>0.084</td></tr> <tr><td>B</td><td>1.15</td><td>1.35</td><td>0.045</td><td>0.055</td></tr> <tr><td>C</td><td>0.80</td><td>1.00</td><td>0.031</td><td>0.040</td></tr> <tr><td>D</td><td>0.15</td><td>0.30</td><td>0.006</td><td>0.012</td></tr> <tr><td>E</td><td>0.65 BSC</td><td>-</td><td>0.0255 BSC</td><td>-</td></tr> <tr><td>F</td><td>1.30 BSC</td><td>-</td><td>0.0512 BSC</td><td>-</td></tr> <tr><td>G</td><td>0.80</td><td>1.10</td><td>0.031</td><td>0.043</td></tr> <tr><td>J</td><td>0.08</td><td>0.25</td><td>0.003</td><td>0.010</td></tr> <tr><td>K</td><td>1.90</td><td>2.15</td><td>0.074</td><td>0.084</td></tr> <tr><td>L</td><td>0</td><td>0.10</td><td>0</td><td>0.004</td></tr> <tr><td>M</td><td>0.26</td><td>0.46</td><td>0.010</td><td>0.018</td></tr> </tbody> </table>	DIM	MILLIMETERS		INCHES		MIN	MAX	MIN	MAX	A	1.90	2.15	0.074	0.084	B	1.15	1.35	0.045	0.055	C	0.80	1.00	0.031	0.040	D	0.15	0.30	0.006	0.012	E	0.65 BSC	-	0.0255 BSC	-	F	1.30 BSC	-	0.0512 BSC	-	G	0.80	1.10	0.031	0.043	J	0.08	0.25	0.003	0.010	K	1.90	2.15	0.074	0.084	L	0	0.10	0	0.004	M	0.26	0.46	0.010	0.018
DIM	MILLIMETERS		INCHES																																																														
	MIN	MAX	MIN	MAX																																																													
A	1.90	2.15	0.074	0.084																																																													
B	1.15	1.35	0.045	0.055																																																													
C	0.80	1.00	0.031	0.040																																																													
D	0.15	0.30	0.006	0.012																																																													
E	0.65 BSC	-	0.0255 BSC	-																																																													
F	1.30 BSC	-	0.0512 BSC	-																																																													
G	0.80	1.10	0.031	0.043																																																													
J	0.08	0.25	0.003	0.010																																																													
K	1.90	2.15	0.074	0.084																																																													
L	0	0.10	0	0.004																																																													
M	0.26	0.46	0.010	0.018																																																													
<p style="text-align: center;">MOUNTING PAD</p> <table border="1" style="width: 100%; border-collapse: collapse; text-align: center;"> <thead> <tr> <th colspan="3">TYPICAL</th> </tr> <tr> <th>DIM</th> <th>Millimeters</th> <th>Inches</th> </tr> </thead> <tbody> <tr><td>1</td><td>0.50</td><td>0.020</td></tr> <tr><td>2</td><td>1.30</td><td>0.051</td></tr> <tr><td>3</td><td>0.65</td><td>0.026</td></tr> <tr><td>4</td><td>1.72</td><td>0.068</td></tr> <tr><td>5</td><td>0.60</td><td>0.024</td></tr> <tr><td>6</td><td>1.11</td><td>0.044</td></tr> <tr><td>7</td><td>2.33</td><td>0.092</td></tr> </tbody> </table>	TYPICAL			DIM	Millimeters	Inches	1	0.50	0.020	2	1.30	0.051	3	0.65	0.026	4	1.72	0.068	5	0.60	0.024	6	1.11	0.044	7	2.33	0.092	<p>NOTES</p> <ol style="list-style-type: none"> 1. Dimensioning and tolerances per ANSI Y14.5M, 1985. 2. Controlling Dimension: Inches 3. Dimensions are exclusive of mold flash and metal burrs. <p>TAPE & REEL ORDERING NOMENCLATURE</p> <ol style="list-style-type: none"> 1. Surface mount product is taped and reeled in accordance with EIA-481. 2. Suffix-T7 = 7 Inch Reel - 3,000 pieces per 8mm tape, i.e., PSMF05-T7. 3. Suffix-LF = Lead-Free, Pure Tin Plating, i.e., PSMF05-LF-T7. <p style="text-align: right;">Outline & Dimensions: Rev 2 - 10/05, 06005</p>																																					
TYPICAL																																																																	
DIM	Millimeters	Inches																																																															
1	0.50	0.020																																																															
2	1.30	0.051																																																															
3	0.65	0.026																																																															
4	1.72	0.068																																																															
5	0.60	0.024																																																															
6	1.11	0.044																																																															
7	2.33	0.092																																																															

Tape & Reel Specifications (Dimensions in millimeters)

Reel Dia.	Tape Width	A0	B0	K0	D	E	F	W	P0	P2	P	tmax
178mm (7")	8mm	2.25 ± 0.10	2.34 ± 0.10	1.22 ± 0.10	1.50 ± 0.10	1.75 ± 0.10	3.50 ± 0.05	8.00 ± 0.30	4.00 ± 0.10	2.00 ± 0.05	4.00 ± 0.10	0.25

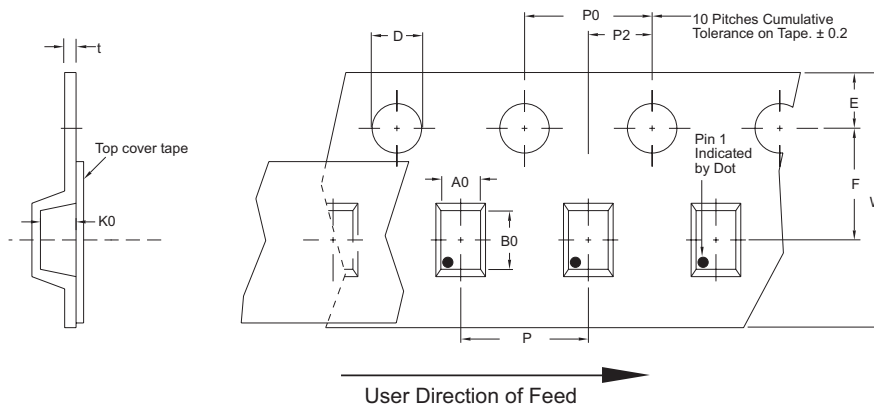

COPYRIGHT © ProTek Devices 2005
SPECIFICATIONS: ProTek reserves the right to change the electrical and or mechanical characteristics described herein without notice (except JEDEC).

DESIGN CHANGES: ProTek reserves the right to discontinue product lines without notice, and that the final judgement concerning selection and specifications is the buyer's and that in furnishing engineering and technical assistance, ProTek assumes no responsibility with respect to the selection or specifications of such products.

ProTek Devices
2929 South Fair Lane, Tempe, AZ 85282
Tel: 602-431-8101 Fax: 602-431-2288
E-Mail: sales@protekdevices.com
Web Site: www.protekdevices.com