

500 WATT ULTRA LOW CAPACITANCE TVS ARRAY



DESCRIPTION

The PSOTxxLC series are ultra low capacitance transient voltage suppressor (TVS) arrays, designed for power or data line applications that provide protection against ESD, tertiary lightning and switching transients. This series offers low clamping voltage for the protection of sensitive components.

The PSOTxxLC series has a peak pulse power of 500 Watts for an 8/20 μ s waveshape and is available in a SOT-23 package configuration. This series meets the IEC 61000-4-2, 61000-4-4 and IEC 61000-4-5 requirements.

FEATURES

- Compatible with IEC 61000-4-2 (ESD): Air 15kV, Contact 8kV
- Compatible with IEC 61000-4-4 (EFT): 40A, 5/50ns
- Compatible with IEC 61000-4-5 (Surge): 12A, 8/20 μ s - Level 1(Line-Ground) & Level 2(Line-Line)
- 500 Watts Peak Pulse Power per Line(tp = 8/20 μ s)
- Low Clamping Voltage
- Ultra Low Capacitance
- Available in Multiple Voltages Ranging from 3V to 36V
- RoHS Compliant
- REACH Compliant

APPLICATIONS

- Ethernet 10/100 Base T
- Cellular Phones
- FireWire
- Audio/Video Inputs
- Portable Electronics

MECHANICAL CHARACTERISTICS

- Molded JEDEC SOT-23 Package
- Approximate Weight: 8 milligrams
- Lead-Free Pure-Tin Plating (Annealed)
- Solder Reflow Temperature:
Pure-Tin - Sn, 100: 260-270°C
- Flammability Rating UL 94V-0
- 8mm Tape and Reel per EIA Standard 481

PIN CONFIGURATION

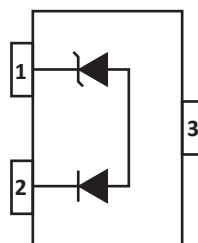

TYPICAL DEVICE CHARACTERISTICS
MAXIMUM RATINGS @ 25°C Unless Otherwise Specified

PARAMETER	SYMBOL	VALUE	UNITS
Peak Pulse Power (tp = 8/20μs) - See Figure 1	P _{PP}	500	Watts
Operating Temperature	T _L	-55 to 150	°C
Storage Temperature	T _{STG}	-55 to 150	°C

ELECTRICAL CHARACTERISTICS PER LINE @ 25°C Unless Otherwise Specified

PART NUMBER (Note 1)	DEVICE MARKING	RATED STAND-OFF VOLTAGE V _{WM} VOLTS	MINIMUM BREAKDOWN VOLTAGE (Note 2) @ 1mA V _(BR) VOLTS	MAXIMUM CLAMPING VOLTAGE (Fig. 2) @ I _p = 1A V _C VOLTS	MAXIMUM CLAMPING VOLTAGE (Fig. 2) @ I _p = 5A V _C VOLTS	MAXIMUM LEAKAGE CURRENT @V _{WM} I _D μA	TYPICAL CAPACITANCE @0V, 1MHz C pF
PSOT03LC	03L	3.3	4.0	7.0	9.0	125	5
PSOT05LC	05L	5.0	6.0	9.8	11.0	20	5
PSOT08LC	08L	8.0	8.5	13.4	15.0	10	5
PSOT12LC	12L	12.0	13.3	19.0	23.0	1	5
PSOT15LC	15L	15.0	16.7	24.0	28.0	1	5
PSOT24LC	24L	24.0	26.7	43.0	46.0	1	5
PSOT36LC	36L	36.0	40.0	51.0	68.0	1	5

NOTES

1. Positive potential is applied from pin 1 to 2; pin 2 is ground.
2. Do not test or surge from pin 2 to 1. PIV typically greater than 100V for rectifier diode.

TYPICAL DEVICE CHARACTERISTICS

FIGURE 1
PEAK PULSE POWER VS PULSE TIME

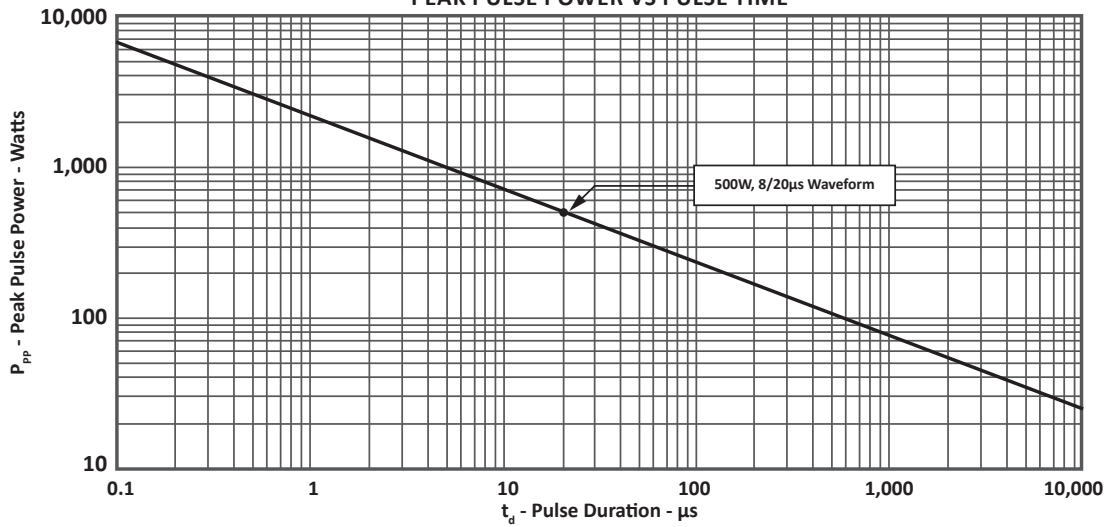

FIGURE 2
PULSE WAVE FORM

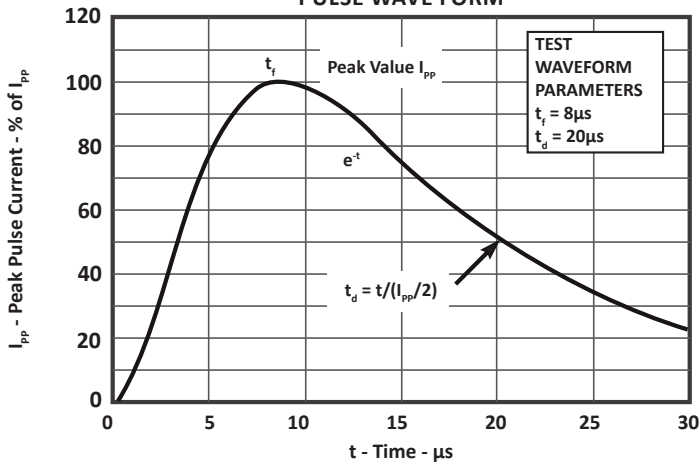
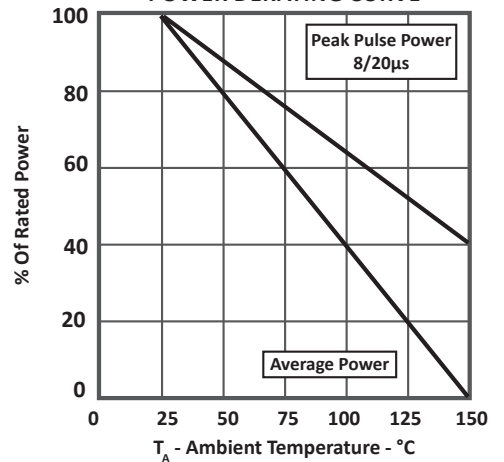
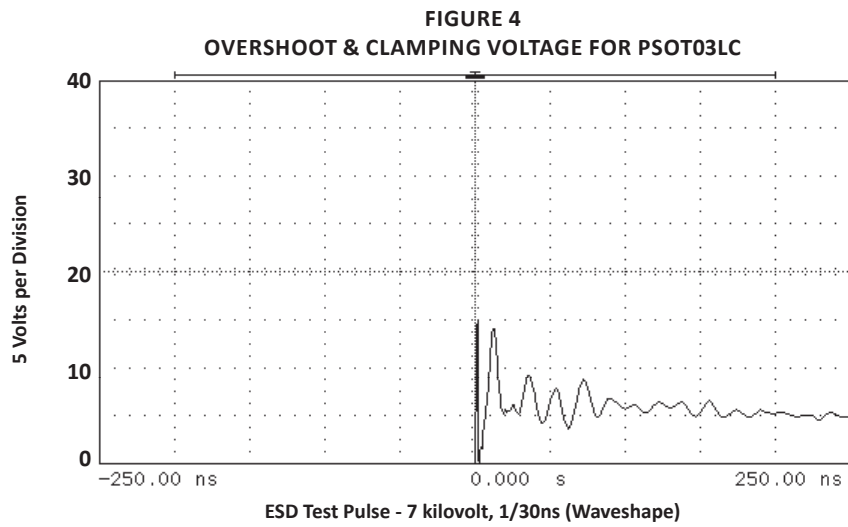

FIGURE 3
POWER DERATING CURVE



TYPICAL DEVICE CHARACTERISTICS



SPICE MODEL

FIGURE 1
SPICE MODEL FOR



ABD - Avalanche Breakdown Diode (TVS)
 LCRD - Low Capacitance Rectifier Diode
 Lg - Lead Inductance

TABLE 1 - SPICE PARAMETERS

PARAMETER	UNIT	ABD(TVS)	LCRD
BV	V	See Table 2	200
IBV	μ A	1	0.01
C_{jo}	pF	See Table 2	5
I_s	A	See Table 2	1E-14
Vj	V	0.6	0.6
M	-	0.33	0.33
N	-	1	1
R_s	Ohms	See Table 2	0.31
TT	s	1E-8	1E-9
EG	eV	1.11	1.11

TABLE 2 - ABD SPECIFIC SPICE PARAMETERS

PART NUMBER	B_v (VOLTS)	C_{jo} (pF)	I_s (AMPS)	R_s (OHMS)
PSOT03LC	4.5	438	1E-11	0.21
PSOT05LC	6.0	284	1E-11	0.14
PSOT08LC	8.5	146	1E-11	0.28
PSOT12LC	13.3	123	1E-13	0.40
PSOT15LC	16.7	102	1E-13	0.52
PSOT12LC	26.7	61	1E-13	1.54

APPLICATION INFORMATION

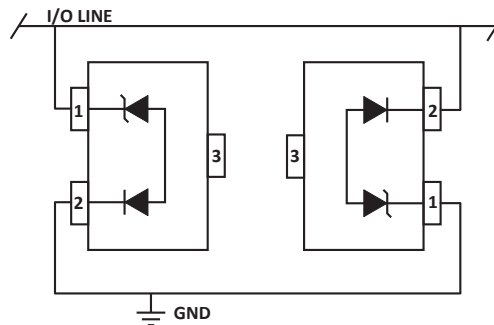

FIGURE 1 - COMMON MODE I/O PORT PROTECTION

Two PSOTxxLC devices used in parallel. Circuit connectivity is as follows:

- I/O Line connected to Device 1, Pin 1.
- I/O Line connected to Device 2, Pin 2.
- Device 1, Pin 2 connected to ground.
- Device 2, Pin 1 connected to ground.
- Device 1 and 2, Pin 3 not connected.

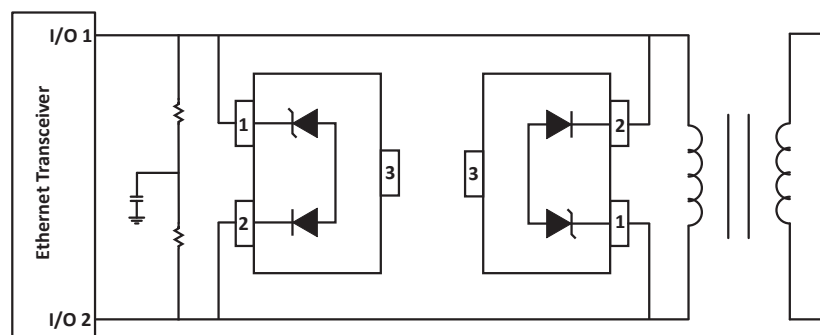

FIGURE 1 - DIFFERENTIAL MODE ETHERNET PROTECTION

Two PSOTxxLC devices used in parallel. Circuit connectivity is as follows:

- I/O Line 1 connected to Device 1, Pin 1.
- I/O Line 1 connected to Device 2, Pin 2.
- I/O Line 2 connected to Device 1, Pin 2.
- I/O Line 2 connected to Device 2, Pin 1.
- Device 1 and 2, Pin 3 not connected.

CIRCUIT BOARD RECOMMENDATIONS

Circuit board layout is critical for electromagnetic compatibility protection. The following guidelines are recommended:

- The protection device should be placed near the input terminals or connectors, the device will divert the transient current immediately before it can be coupled into the nearby traces.
- The path length between the TVS device and the protected line should be minimized.
- All conductive loops including power and ground loops should be minimized.
- The transient current return path to ground should be kept as short as possible to reduce parasitic inductance.
- Ground planes should be used whenever possible. For multilayer PCBs, use dedicated ground planes

SOT-23 PACKAGE INFORMATION

OUTLINE DIMENSIONS

DIM	MILLIMETERS		INCHES	
	MIN	MAX	MIN	MAX
A	2.80	3.04	0.110	0.120
B	1.20	1.40	0.047	0.055
C	0.89	1.11	0.035	0.044
D	0.37	0.50	0.015	0.020
G	1.78	2.04	0.070	0.081
H	0.013	0.100	0.001	0.004
J	0.085	0.177	0.003	0.007
K	0.45	0.60	0.018	0.024
L	0.89	1.02	0.035	0.040
S	2.10	2.50	0.083	0.098
V	0.45	0.60	0.018	0.024

NOTES

1. Controlling dimension: inches.
2. Dimensioning and tolerances per ANSI Y14.5M, 1985.
3. Pin 3 is the cathode (Unidirectional Only)
4. Dimensions are exclusive of mold flash and metal burrs.

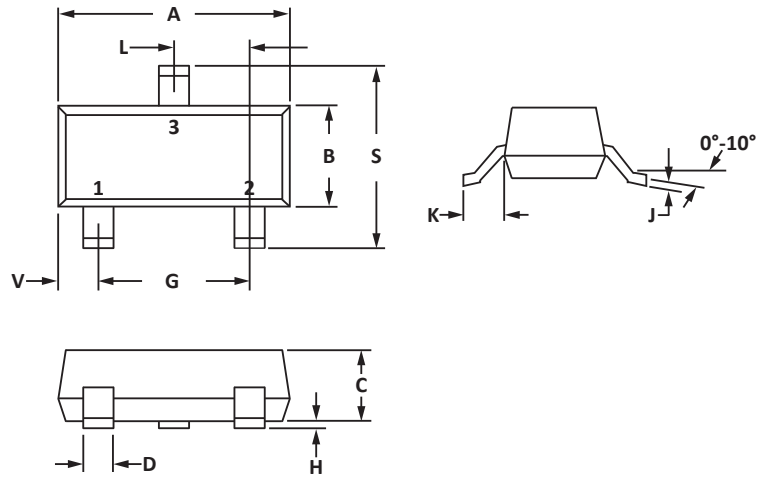

PAD LAYOUT DIMENSIONS

DIM	MILLIMETERS		INCHES	
	MIN	MAX	MIN	MAX
A	0.71	0.97	0.028	0.038
B	1.88	2.13	0.074	0.084
C	0.71	0.97	0.028	0.038
D	0.81	1.07	0.032	0.042

NOTES

1. Controlling dimension: inches.

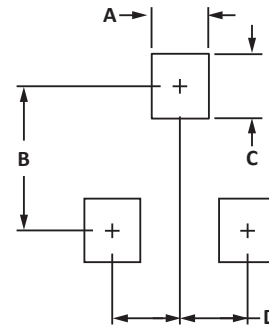

TAPE AND REEL

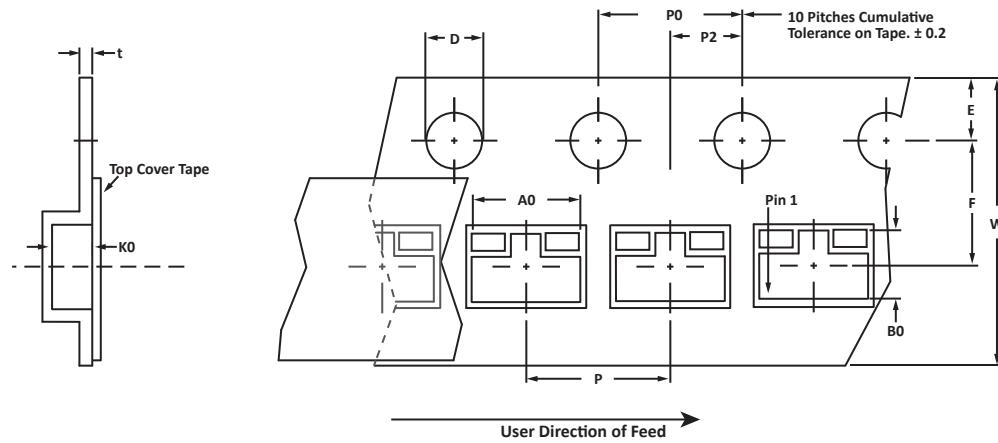

SPECIFICATIONS

REEL DIA.	TAPE WIDTH	A0	B0	K0	D	E	F	W	P0	P2	P	tmax
178mm (7")	8mm	3.15 ± 0.10	2.77 ± 0.10	1.30 ± 0.10	1.55 ± 0.10	1.75 ± 0.10	3.50 ± 0.05	8.00 ± 0.30	4.00 ± 0.10	2.00 ± 0.05	4.00 ± 0.10	0.228

NOTES

- Dimensions are in millimeters.
- Surface mount product is taped and reeled in accordance with EIA-481.
- Suffix - T7 = 7" Reel - 3,000 pieces per 8mm tape.
- Suffix - T13 = 13" Reel - 10,000 pieces per 8mm tape.
- Marking on Part - marking code (see page 2) and date code.

Package outline, pad layout and tape specifications per document number 06012.R2 8/10.

ORDERING INFORMATION

BASE PART NUMBER (xx = Voltage)	LEADFREE SUFFIX	TAPE SUFFIX	QTY/REEL	REEL SIZE	TUBE QTY
PSOTxxLC	-LF	-T7	3,000	7"	n/a
PSOTxxLC	-LF	-T13	10,000	13"	n/a

COMPANY INFORMATION

COMPANY PROFILE

ProTek Devices, based in Tempe, Arizona USA, is a manufacturer of Transient Voltage Suppression (TVS) products designed specifically for the protection of electronic systems from the effects of lightning, Electrostatic Discharge (ESD), Nuclear Electromagnetic Pulse (NEMP), inductive switching and EMI/RFI. With over 25 years of engineering and manufacturing experience, ProTek designs TVS devices that provide application specific protection solutions for all electronic equipment/systems.

ProTek Devices Analog Products Division, also manufactures analog interface, control, RF and power management products.

CONTACT US

Corporate Headquarters

2929 South Fair Lane
Tempe, Arizona 85282
USA

By Telephone

General: 602-431-8101
Sales: 602-414-5109
Customer Service: 602-414-5114

By Fax

General: 602-431-2288

By E-mail:

Sales: sales@protekdevices.com
Customer Service: service@protekdevices.com
Technical Support: support@protekdevices.com

Web

www.protekdevices.com
www.protekanalog.com

COPYRIGHT © ProTek Devices 1998 - This literature is subject to all applicable copyright laws and is not for resale in any manner.

SPECIFICATIONS: ProTek reserves the right to change the electrical and or mechanical characteristics described herein without notice.

DESIGN CHANGES: ProTek reserves the right to discontinue product lines without notice and that the final judgement concerning selection and specifications is the buyer's and that in furnishing engineering and technical assistance. ProTek assumes no responsibility with respect to the selection or specifications of such products. ProTek makes no warranty, representation or guarantee regarding the suitability of its products for any particular purpose, nor does ProTek assume any liability arising out of the application or use of any product or circuit and specifically disclaims any and all liability without limitation special, consequential or incidental damages.

LIFE SUPPORT POLICY: ProTek Devices products are not authorized for use in life support systems without written consent from the factory.