

PV548BA

N-Channel Enhancement Mode MOSFET

PRODUCT SUMMARY

$V_{(BR)DSS}$	$R_{DS(ON)}$	I_D
30V	5.6mΩ @ $V_{GS} = 10V$	14A

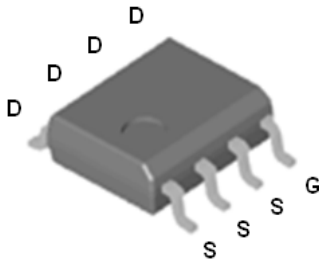

SOP-8

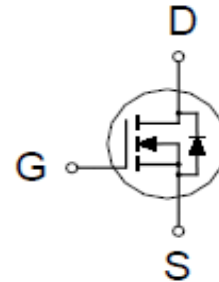

ABSOLUTE MAXIMUM RATINGS ($T_A = 25\text{ °C}$ Unless Otherwise Noted)

PARAMETERS/TEST CONDITIONS		SYMBOL	LIMITS	UNITS
Drain-Source Voltage		V_{DS}	30	V
Gate-Source Voltage		V_{GS}	±20	
Continuous Drain Current	$T_A = 25\text{ °C}$	I_D	14	A
	$T_A = 70\text{ °C}$		11	
Pulsed Drain Current ¹		I_{DM}	150	
Avalanche Current		I_{AS}	36.3	
Avalanche Energy	$L = 0.1\text{mH}$	E_{AS}	65.9	mJ
Power Dissipation	$T_A = 25\text{ °C}$	P_D	1.9	W
	$T_A = 70\text{ °C}$		1.2	
Junction & Storage Temperature Range		T_j, T_{stg}	-55 to 150	°C

THERMAL RESISTANCE RATINGS

THERMAL RESISTANCE	SYMBOL	TYPICAL	MAXIMUM	UNITS
Junction-to-Ambient	$R_{\theta JA}$		65	°C / W
Junction-to-Case	$R_{\theta JC}$		25	

¹Pulse width limited by maximum junction temperature.

²The value of $R_{\theta JA}$ is measured with the device mounted on 1in² FR-4 board with 2oz. Copper, in a still air environment with $T_A = 25\text{ °C}$.

PV548BA

N-Channel Enhancement Mode MOSFET

ELECTRICAL CHARACTERISTICS (T_J = 25 °C, Unless Otherwise Noted)

PARAMETER	SYMBOL	TEST CONDITIONS	LIMITS			UNITS
			MIN	TYP	MAX	
STATIC						
Drain-Source Breakdown Voltage	V _{(BR)DSS}	V _{GS} = 0V, I _D = 250μA	30			V
Gate Threshold Voltage	V _{GS(th)}	V _{DS} = V _{GS} , I _D = 250μA	1	1.6	3	V
Gate-Body Leakage	I _{GSS}	V _{DS} = 0V, V _{GS} = ±20V			±100	nA
Zero Gate Voltage Drain Current	I _{DSS}	V _{DS} = 24V, V _{GS} = 0V			1	μA
		V _{DS} = 20V, V _{GS} = 0V, T _J = 70 °C			10	
Drain-Source On-State Resistance ¹	R _{DS(ON)}	V _{GS} = 4.5V, I _D = 14A		5	7.2	mΩ
		V _{GS} = 10V, I _D = 14A		4.4	5.6	
Forward Transconductance ¹	g _{fs}	V _{DS} = 5V, I _D = 14A		80		S
DYNAMIC						
Input Capacitance	C _{iss}	V _{GS} = 0V, V _{DS} = 15V, f = 1MHz		2280		pF
Output Capacitance	C _{oss}			343		
Reverse Transfer Capacitance	C _{rss}			289		
Gate Resistance	R _g	V _{GS} = 0V, V _{DS} = 0V, f = 1MHz		0.9		Ω
Total Gate Charge ²	Q _g (V _{GS} =10V)	V _{DS} = 15V, I _D = 14A		54.4		nC
	Q _g (V _{GS} =4.5V)			28.8		
Gate-Source Charge ²	Q _{gs}			6.5		
Gate-Drain Charge ²	Q _{gd}			14.2		
Turn-On Delay Time ²	t _{d(on)}		V _{DS} = 15V, I _D ≅ 14A, V _{GS} = 10V, R _{GEN} = 6Ω		24	
Rise Time ²	t _r			16		
Turn-Off Delay Time ²	t _{d(off)}			63		
Fall Time ²	t _f			24		
SOURCE-DRAIN DIODE RATINGS AND CHARACTERISTICS (T_J = 25 °C)						
Continuous Current	I _S				1.9	A
Forward Voltage ¹	V _{SD}	I _F = 14A, V _{GS} = 0V			1	V
Reverse Recovery Time	t _{rr}	I _F = 14A, di _F /dt = 100A / μS		26		nS
Reverse Recovery Charge	Q _{rr}				13	

¹Pulse test : Pulse Width ≤ 300 μsec, Duty Cycle ≤ 2%.

²Independent of operating temperature.

PV548BA

N-Channel Enhancement Mode MOSFET

Output Characteristics

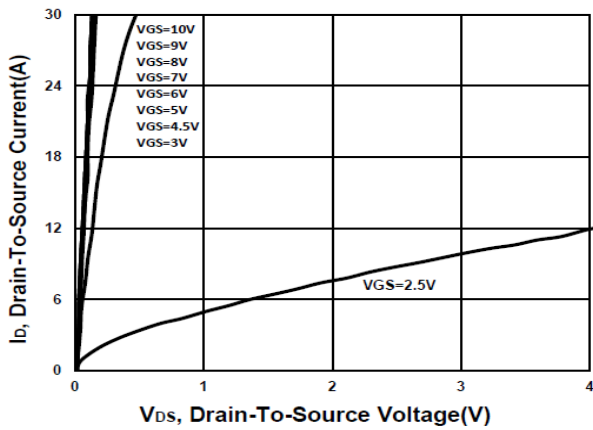

Transfer Characteristics

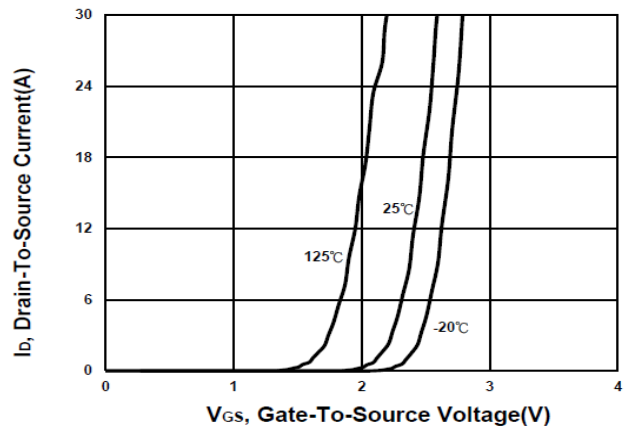

On-Resistance VS Temperature

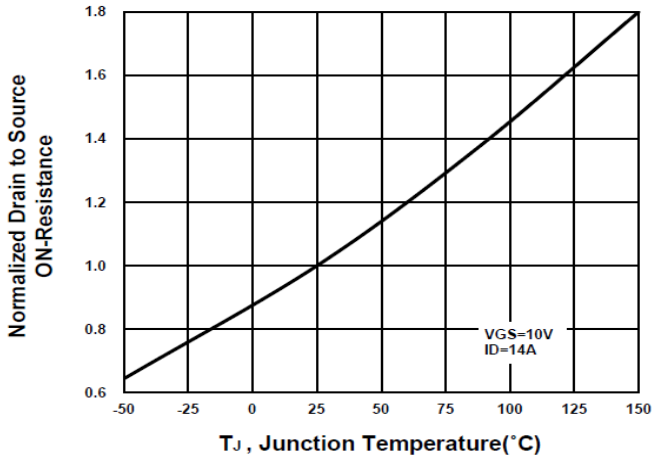

Capacitance Characteristic

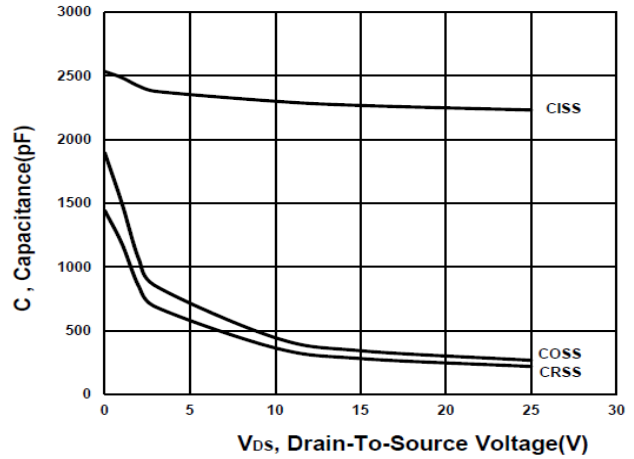

Gate charge Characteristics

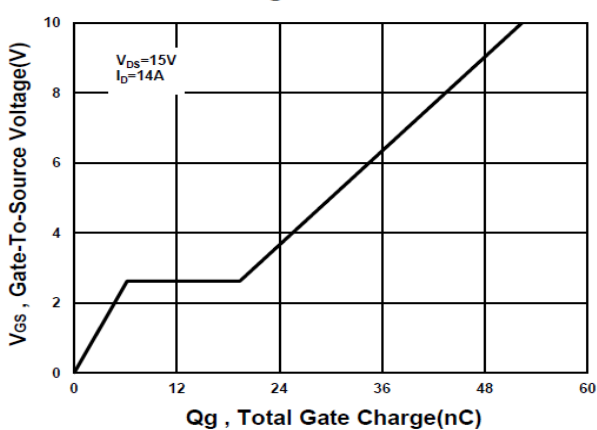

Source-Drain Diode Forward Voltage

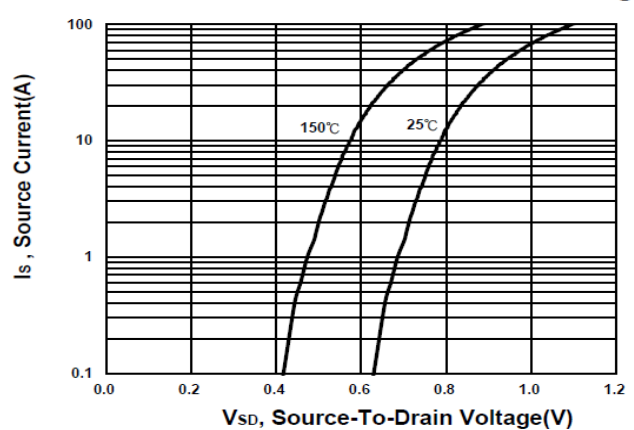

PV548BA

N-Channel Enhancement Mode MOSFET

Safe Operating Area

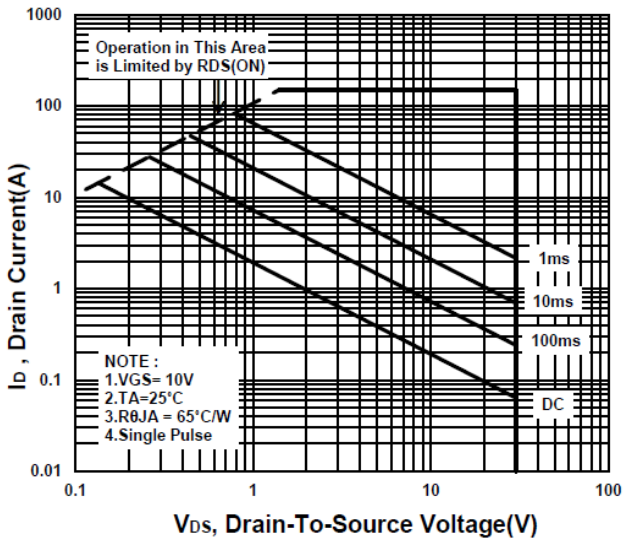

Single Pulse Maximum Power Dissipation

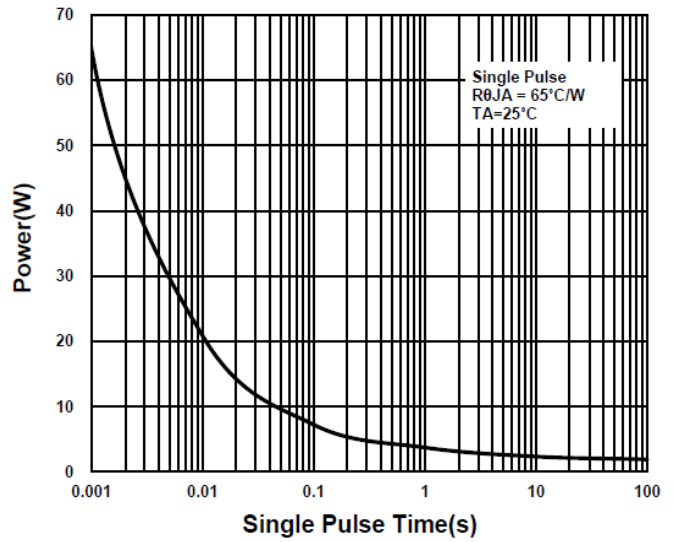

Transient Thermal Response Curve

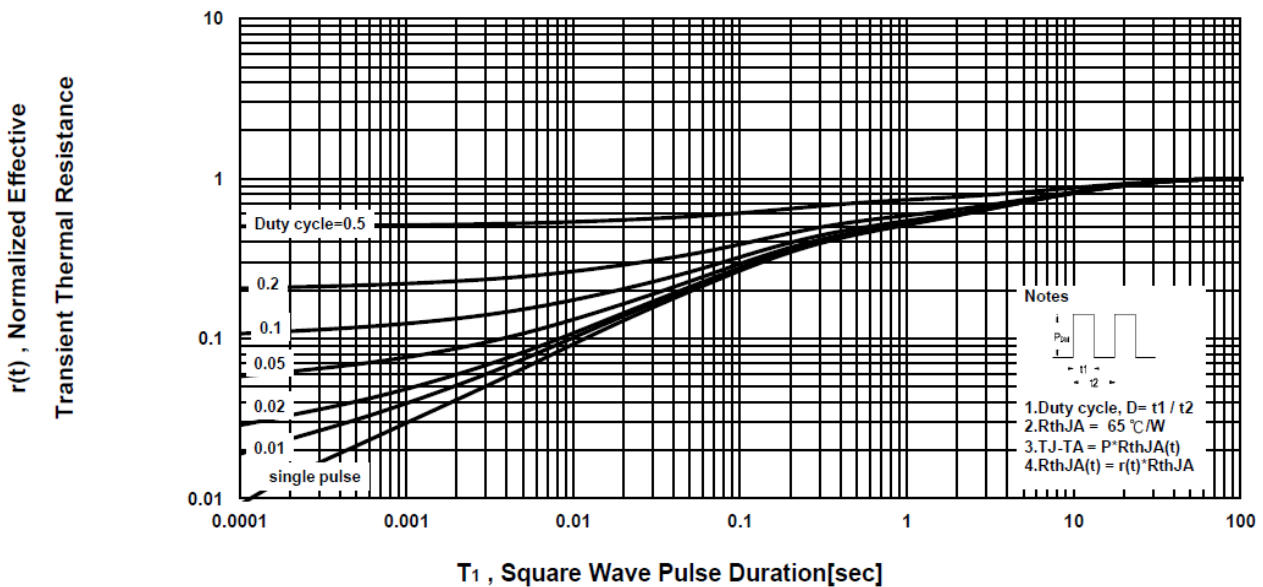

PV548BA

N-Channel Enhancement Mode MOSFET

Package Dimension

SOP-8 MECHANICAL DATA

Dimension	mm			Dimension	mm		
	Min.	Typ.	Max.		Min.	Typ.	Max.
A	4.8	4.9	5.0	H	0.4	0.6	0.93
B	3.8	3.9	4.0	I	0.19	0.21	0.25
C	5.79	6.0	6.2	J	0.25	0.375	0.5
D	0.33	0.4	0.51	K	0°	3°	18°
E	1.25	1.27	1.29				
F	1.1	1.3	1.65				
G	0.05	0.15	0.25				

