

R-GAGE® Q130RA Sensor

Instruction Manual

Original Instructions
208831 Rev. B
15 May 2019
© Banner Engineering Corp. All rights reserved



208831

Contents

1 Product Description	3
1.1 Models	3
1.2 Overview	3
1.3 Banner Radar Configuration Software	4
1.4 Features and Indicators	4
2 Installation Instructions	6
2.1 Sensor Orientation	6
2.2 Mount the Device	6
2.3 Wiring	6
2.4 Install the Software	6
3 Getting Started	8
3.1 Connect to the Sensor	8
3.2 Software Overview	8
4 Banner Radar Configuration Workspace	9
4.1 Navigation Toolbar	9
4.2 Live Sensor Data and Legend	9
4.3 Summary Pane	10
4.4 Sensor Settings Pane	10
4.5 Live Sensor Data Controls	11
5 Remote Input	12
5.1 Teach Output 1 Switch Point	12
5.2 Remote Setup	13
5.3 Set the Sensitivity	14
6 Reset the Sensor to Factory Defaults	15
6.1 Factory Default Settings	15
7 Specifications	16
7.1 FCC Part 15 and CAN ICES-3 (B)/NMB-3(B)	16
7.2 PC Requirements	17
7.3 Beam Patterns	17
7.4 Dimensions	20
8 Windows	21
9 Update the Software	22
10 Accessories	23
10.1 Configuration Tool	23
10.2 Quick Disconnect (QD) Cordsets	23
10.3 Brackets and Enclosures	23
11 Product Support and Maintenance	25
11.1 Repairs	25
11.2 Contact Us	25
11.3 Banner Engineering Corp. Software Copyright Notice	25
11.4 Banner Engineering Corp. Limited Warranty	25

1 Product Description

Radar-Based Sensors for Detection of Moving and Stationary Targets

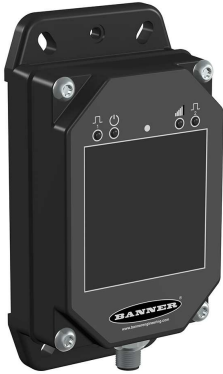

- FMCW radar detects moving and stationary objects
- Adjustable sensing field—ignores objects beyond setpoint
- Easy setup and configuration of range, sensitivity, and output using the Banner Radar Configuration Software and Pro Converter Cable
- Sensing functions are unaffected by wind, falling rain or snow, fog, humidity, air temperatures, or light
- Sensor operates in Industrial, Scientific, and Medical (ISM) telecommunication band
- Rugged IP67 housing withstands harsh environments



WARNING:

- **Do not use this device for personnel protection**
- Using this device for personnel protection could result in serious injury or death.
- This device does not include the self-checking redundant circuitry necessary to allow its use in personnel safety applications. A device failure or malfunction can cause either an energized (on) or de-energized (off) output condition.

1.1 Models

Models	Maximum Range	Beam Angle	Telecom Approval ¹	Output	Connection ²
Q130RA-9076-AFQ	24 m (78.7 ft)	90° × 76°	Telecom approved for US, UK, Europe, China, Australia, and New Zealand	Bipolar NPN/PNP N.O./N.C. Configurable	Integral 5-pin Euro-style (M12) quick-disconnect (QD)
Q130RA-2450-AFQ	40 m (131.2 ft)	24° × 50°			

1.2 Overview

The R-GAGE sensor emits a well-defined beam of high-frequency radio waves from an internal antenna. Some of this emitted energy reflects back to the receiving antenna. Signal processing electronics in the sensor determine the distance from the sensor to the object based on the time delay of the return signal. The sensor can be configured (using a PC or remote input wire) to sense objects up to a specific distance, ignoring objects beyond this distance (also called background suppression).

¹ For additional countries, contact Banner Engineering.

² Models with a quick disconnect require a mating cordset. See [Quick Disconnect \(QD\) Cordsets](#) on page 23.

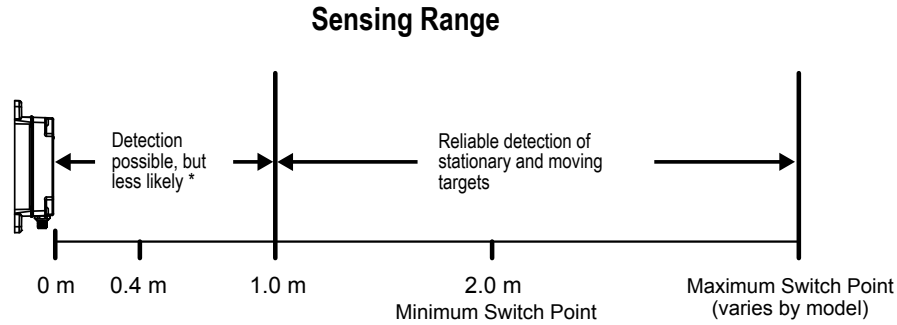

*The specific detection range depends on the radar cross section and returned signal strength of the specific target. Moving targets provide a stronger signal and are more likely to be detected at closer distances. Typical stationary targets can be detected as close as 1 meter (3.3 feet). Typical moving targets can be detected as close as 0.4 meters (1.3 feet).

Figure 1. Sensing Range

1.3 Banner Radar Configuration Software

Use the Banner Radar Configuration software and Pro Converter Cable to set up the R-GAGE sensor.

For more information visit www.bannerengineering.com/us/en/products/sensors/software/radar-configuration.html.

1.4 Features and Indicators

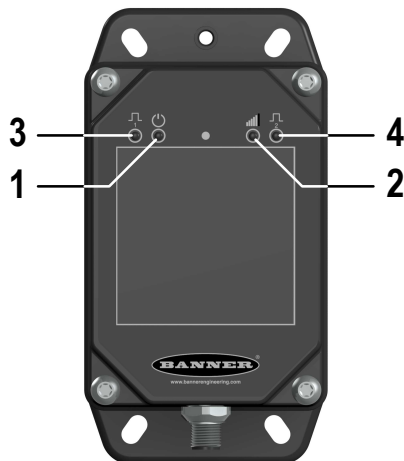

Figure 2. R-GAGE Features

	LED	Color	Description
1	Power	Green	Power ON
2	Signal Strength	Red	Flashes in proportion to the signal strength
3	Output 1	Amber	Output energized
4	Output 2	Amber	Output energized

Signal Strength and the Indicator LEDs

The Signal Strength indicator flashes in proportion to the signal strength. It flashes slowly when signal strength is above one. The flashing frequency increases until signal strength is four times the user-selected signal strength threshold. At this point, the Signal Strength indicator is on and does not flash.

LED Status		Description
Signal Strength	Output 1/2	
Off	Normally Open = Off Normally Closed = On	There is no detectable object within the switch point distance that is returning a signal greater than the minimum signal strength threshold of one.
Flashing	Normally Open = Off Normally Closed = On	An object is detected, however, the output is off because the returned signal strength is below the user-defined threshold. The flash rate increases as the signal strength increases.
Flashing	Normally Open = On Normally Closed = Off	A target is detected and the returned signal strength is stronger than the user-defined threshold. The flash rate increases as the signal strength increases.
On	Normally Open = On Normally Closed = Off	A target is detected and the signal is four times stronger than the user-defined signal strength threshold.

2 Installation Instructions

2.1 Sensor Orientation

Correct sensor-to-object orientation is important to ensure proper sensing.

Minimize the tilt angle of a target relative to the sensor. The target should be titled less than half of the beam angle.

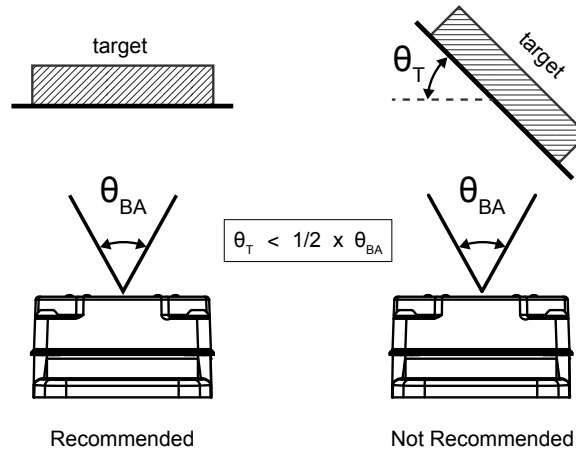
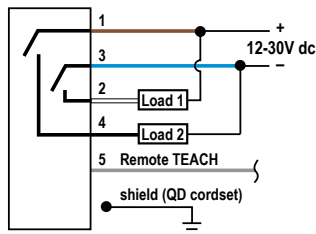

Figure 3. Tilt angle of the target relative to the sensor

2.2 Mount the Device

1. If a bracket is needed, mount the device onto the bracket.
2. Mount the device (or the device and the bracket) to the machine or equipment at the desired location. Do not tighten the mounting screws at this time.
3. Check the device alignment.
This is done via the red Signal Strength LED or the Banner Radar Configuration Software.
4. Tighten the mounting screws to secure the device (or the device and the bracket) in the aligned position.

2.3 Wiring



Key:

- 1 = Brown
- 2 = White
- 3 = Blue
- 4 = Black
- 5 = Gray (Connect for use with remote input)



Note: Banner recommends that the shield wire (quick-disconnect cordsets only) be connected to earth ground or dc common. Shielded cordsets are recommended for all quick-disconnect models.

2.4 Install the Software



Important: Administrative rights are required to install the Banner Radar Configuration software.

1. Download the latest version of the software from www.bannerengineering.com/us/en/products/sensors/software/radar-configuration.html.
2. Navigate to and open the downloaded file.
3. Click **Install** to begin the installation process.
4. Depending on your system settings, a popup window may appear prompting to allow Banner Radar Configuration to make changes to your computer. Click **Yes**.
5. Click **Close** to exit the installer.

3 Getting Started

Power up the sensor, and verify that the power LED is ON green.

3.1 Connect to the Sensor

1. Connect the sensor to the Pro Converter Cable.
2. Connect the Pro Converter Cable to the PC.
3. Open the Banner Radar Configuration Software.
4. Go to **Sensor > Connect** on the **Navigation** toolbar. The **Connection** screen displays.
5. Select the correct **Sensor Model** and **Com Port** for the sensor.
6. Click **Connect**. A message displays confirming the connection to the sensor.
7. Click **OK**. The **Connection** screen closes and the sensor data displays.

3.2 Software Overview

Easy setup and configuration of range, sensitivity, and output using the Banner Radar Configuration and Pro Converter Cable.

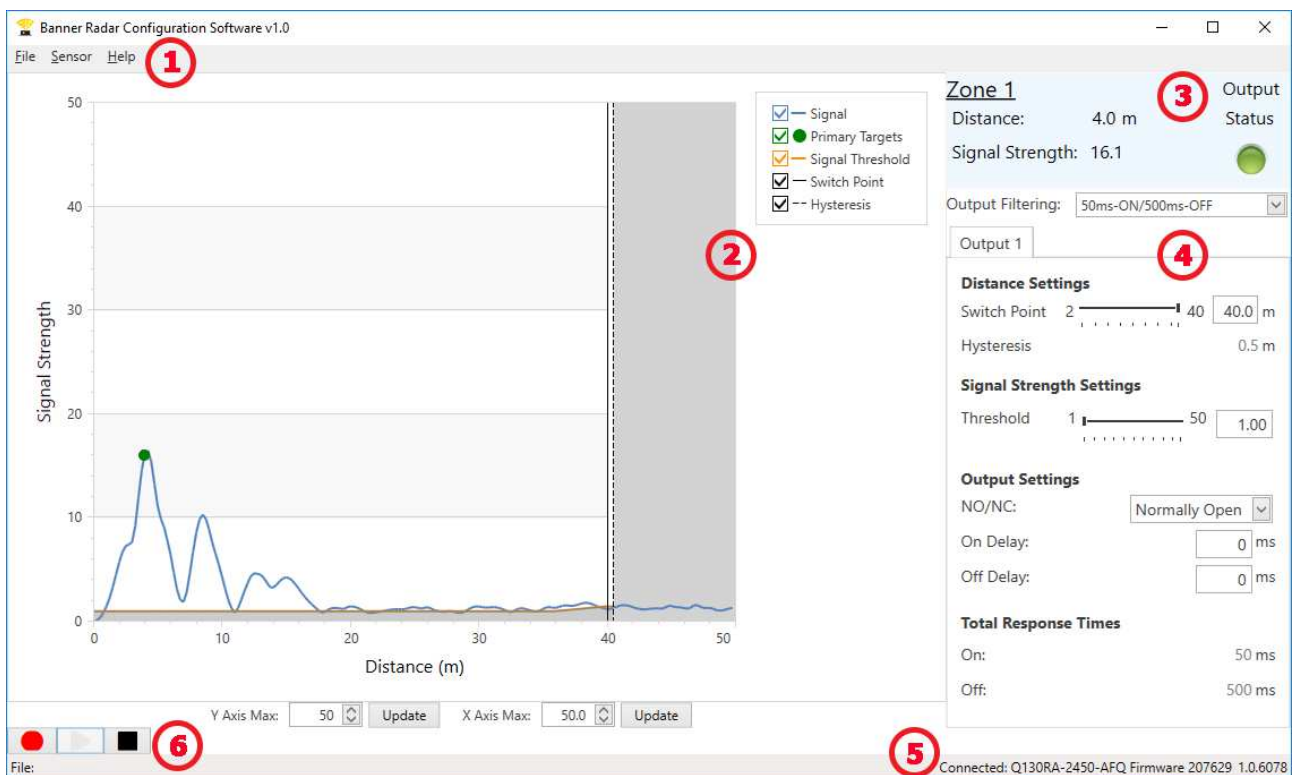

Figure 4. Banner Radar Configuration Software

1. Navigation toolbar—Use this toolbar to connect to the sensor, to save or load a configuration, or to reset to factory defaults
2. Live Sensor Data and Legend—Shows the signal strength versus distance for the connected sensor, as well as options to select which data displays on the graph
3. Summary pane—Displays the distance to the target, the signal strength, and the output status
4. Sensor Settings pane—Set the sensor parameters in this pane
5. Status bar—Shows whether the sensor is connected, if a software update is available, and if the sensor data is being recorded to a file
6. Live Sensor Data controls—Use these controls to record, freeze, and play real-time sensor data

4 Banner Radar Configuration Workspace

4.1 Navigation Toolbar

Use this toolbar to connect to the sensor, to save or load a configuration, or to reset to factory defaults.

From the **File** menu, the following options are available:



Load Config

Load a configuration to the connected sensor. Use this option to set up multiple sensors with the same parameters.

Save Config

Save a configuration to a desired location for future use.



Note: Click  **Stop** in the Live Sensor Data controls to enable **Save Config**. (Click  **Play** to resume live data sampling.)

Exit

Exit the Banner Radar Configuration Software.

From the **Sensor** menu, the following options are available:

Connect

Connect to the sensor.

Disconnect

Disconnect from the sensor.

Factory Reset

Select to perform a factor reset on the sensor. All custom parameters will be lost.

From the **Help** menu, the following option is available:

About

Select to view the software version number, the copyright notice, and the warranty.

4.2 Live Sensor Data and Legend

The Live Sensor Data area displays the live distance and amplitude signal from the connected radar sensor. The signal strength threshold, switch point, and hysteresis are also plotted. Use these signals to evaluate targets to determine where the signal strength threshold and switch point should be configured for reliable detection.

Use the **Y-Axis Max** and the **X-Axis Max** to adjust the range displayed on the plot. Click **Update** to apply changes.

Legend

Use the legend to select which data appears on the graph.

Signal

Displays the strength of the signal over distance.

Primary Targets

Represents the signal strength and location of the strongest target inside the switch point.

Signal Threshold

Displays the signal strength threshold.

Switch Point

Displays the switch point distance.

Hysteresis

Displays the hysteresis distance.

4.3 Summary Pane

The **Summary** pane (blue shaded area) displays **Distance**, **Signal Strength**, and **Output Status**.

Distance

Displays the distance to the target.

Signal Strength

Displays the amount of excess gain of the signal received from the target. The excess gain is relative to the minimum detection threshold (Signal Strength Threshold = 1).

Output Status

Displays whether the output is ON or OFF.

4.4 Sensor Settings Pane

Set parameters for the sensor.

Click **Read** to read the connected sensor's current parameters. Click **Write** to write the parameters to the sensor. Yellow highlight on a parameter's value indicates changes that have not yet been written to the sensor.

The following are the parameters on the **Output 1** tab on the **Sensor Settings** pane.

Output Filtering

Select the desired output filtering from the list. This parameter controls the base response time of the sensor.

Distance Settings

Switch Point: Use the slider or enter the desired switch point, in meters. The **Switch Point** is the distance at which a target of sufficient signal strength causes the sensor's output to change.

Hysteresis: Displays the hysteresis value in meters. **Hysteresis** defines the difference in distance between where the output turns on and off. **Hysteresis** is intended to prevent the output from chattering.

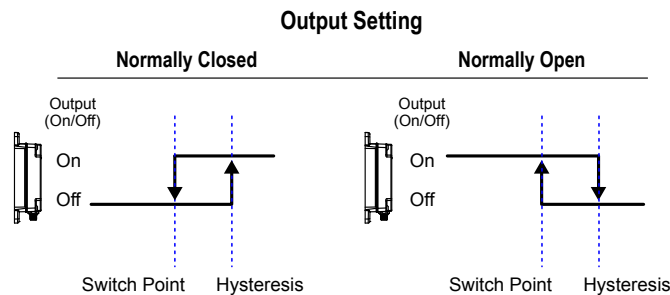

Figure 5. How hysteresis affects the sensor output

Signal Strength Settings

Threshold: Use the slider or enter the desired threshold. The **Threshold** defines the minimum signal strength of the target that is required to change the output state.

Output Settings

NO/NC: Select **Normally Open** or **Normally Closed** from the list.

On Delay: Set an on delay in milliseconds. This value is in addition to the base response time determined by the **Output Filtering**.

Off Delay: Set an off delay in milliseconds. This value is in addition to the base response time determined by the **Output Filtering**.

Total Response Times

On: Displays the total On response time in milliseconds. This value is the sum of the base response time and the **On Delay**.

Off: Displays the Off response time in milliseconds. This value is the sum of the base response time and the **Off Delay**.

4.5 Live Sensor Data Controls

After connecting to the sensor, data sampling begins automatically (but not recording).

To stop data sampling, click  **Stop**. This is required to load/save a configuration.

To restart data sampling, click  **Play**. This only samples data from the sensor and displays it on the plot; it does not record the data to a log file.

To record data to a log file, click  **Record**. The log file selection prompt displays. Save the log file as desired. The log file format is Common Data Format v3.7.0.

5 Remote Input

Use the remote input to program the sensor remotely.

The remote input provides limited programming options and is Active Low. Connect the gray input wire to ground (0 V dc), with a remote switch connected between the wire and ground. Remote teach can also be performed using the button on the Pro Converter Cable. The remote input wire is disabled by default. Pulse the remote input wire 10 times to enable the feature. After enabling the remote input feature, pulse the remote input according to the diagram and the instructions provided in this manual.

To use the Pro Converter Cable for remote input, click **Stop** in the Banner Radar Configuration Software before pressing the button on the cable. The Software cannot be sampling data while remote input is in use.

The length of the individual programming pulses is equal to the value T: **0.04 seconds ≤ T ≤ 0.8 seconds**.

Exit remote programming modes by setting the remote input Low for longer than 2 seconds or by waiting for 60 seconds.

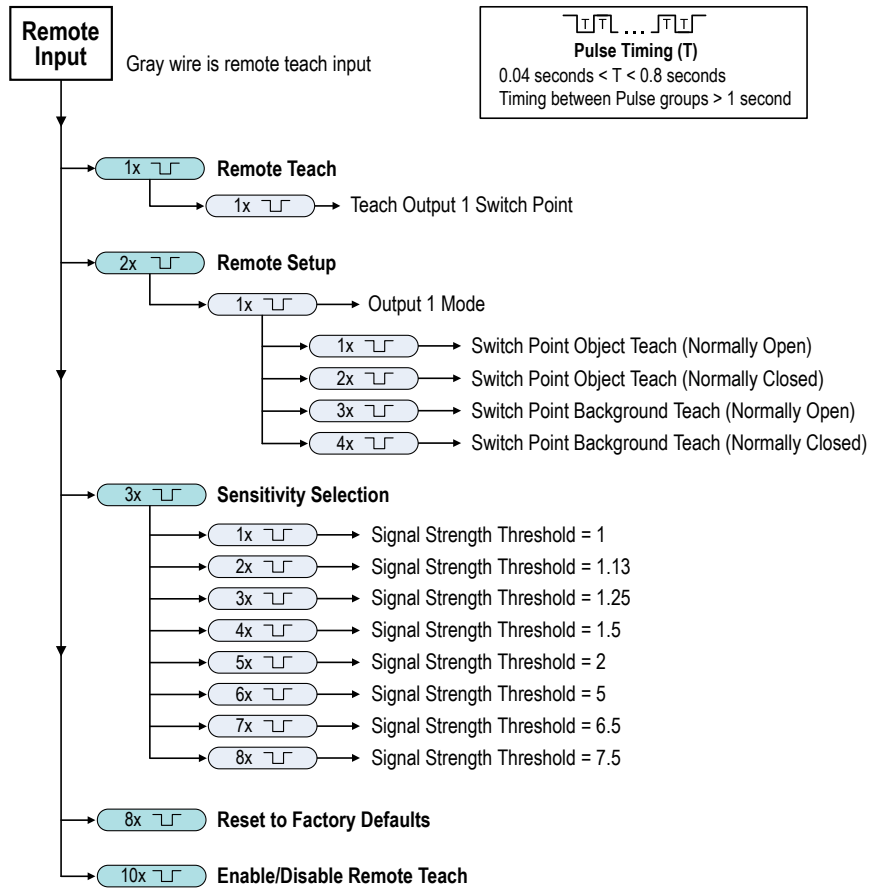



Figure 6. Remote Input Map



Note: If a factory reset is performed through the Banner Radar Configuration Software, the remote input wire becomes disabled (factory default setting). If the sensor is returned to factory defaults by using the remote input wire, the input wire remains enabled and the rest of the settings are restored to factory defaults.

5.1 Teach Output 1 Switch Point

1. Pulse the remote input once. The green power LED flashes slowly.
2. Present the target.
3. Teach the Output 1 switch point.

Action	Result
Single-pulse the remote input. 	The green power LED flashes, alternating with the amber Output LEDs. Teach Accepted The sensor flashes the green power LED three times, then exits remote teach and returns to run mode. Teach Not Accepted The green Power and red Signal Strength LEDs alternate flashing and the switch point automatically moves to the maximum range (the same range as the factory default).

5.2 Remote Setup

Use Remote Setup to set the output mode to either Switch Point Object Teach or Switch Point Background Teach and to set normally open or normally closed.

Changing the Output 1 Mode using remote input affects both the output configuration (normally open versus normally closed) and the Teach mode. The output configuration change takes effect immediately and can be used to change the output between normally open and normally closed without changing the switch point distance. The change in Teach mode does not immediately change the switch point location, but will affect the behavior of the next remote Teach.

Switch Point Object Teach sets the switch point 0.5 meters (1.6 feet) beyond the location of the target, farther away from the sensor's face. Use Switch Point Object Teach so that the sensor can reliably detect when a target is in the same position as when it was configured.

Switch Point Background Teach sets the switch point 1 meter (3.3 feet) in front of the target, closer to the sensor's face. Use Switch Point Background Teach to reliably ignore the taught background and reliably detect an object that is present in front of the taught background.

1. Access Remote Setup.

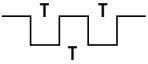
Action	Result
Double-pulse the remote input. 	The green power LED flashes slowly.

2. Single pulse the remote input to enter Output 1 mode.
3. Select the desired output mode.

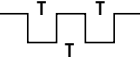
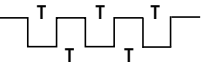
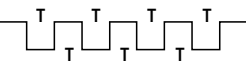
Action		Result
Pulses	Output Mode	The green Power LED flashes three times, Normally Open/Normally Closed changes occur immediately, and the next and any subsequent remote teach are configured to be background or object (see Teach Output 1 Switch Point on page 12). The sensor exits remote teach and returns to run mode.
1 	Switch Point Object Teach (Normally Open)	
2 	Switch Point Object Teach (Normally Closed)	
3 	Switch Point Background Teach (Normally Open)	
4 	Switch Point Background Teach (Normally Closed)	



5.3 Set the Sensitivity

Use Sensitivity Selection to set the signal strength threshold.

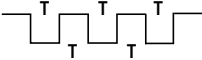
1. Access Sensitivity Selection.

Action		Result
Triple-pulse the remote input.		The green power LED flashes slowly.

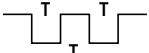
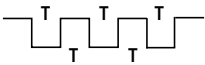
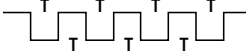
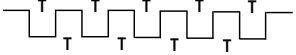
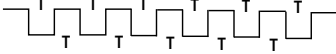
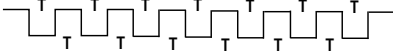
2. Select the desired signal threshold.

Action		Result
Pulses	TEACH Mode	The signal strength is set and the green power LED on the sensor flashes three times. The sensor exits remote teach and returns to run mode.
1 	Signal Strength Threshold = 1	
2 	Signal Strength Threshold = 1.13	
3 	Signal Strength Threshold = 1.25	
4 	Signal Strength Threshold = 1.5	
5 	Signal Strength Threshold = 2	
6 	Signal Strength Threshold = 5	
7 	Signal Strength Threshold = 6.5	
8 	Signal Strength Threshold = 7.5	

6 Reset the Sensor to Factory Defaults

Reset the sensor to factory default settings using one of two methods.



Note: If a factory reset is performed through the Banner Radar Configuration Software, the remote input wire becomes disabled (factory default setting). If the sensor is returned to factory defaults by using the remote input wire, the input wire remains enabled and the rest of the settings are restored to factory defaults.

Reset Using the Banner Radar Configuration Software

Go to **Sensor > Factory Reset**. The sensor indicators flash once, the sensor is reset back to the factory default settings, and a confirmation message displays.

Reset Using the Remote Input

Eight-pulse the remote input to apply the factory defaults.



6.1 Factory Default Settings

Setting	Factory Default
Distance Switch Point	9076 models: 24 m 2450 models: 40 m
N.O./N.C.	Normally Open
On Delay	0 ms
Off Delay	0 ms
Output filtering	50 ms-ON/500 ms-OFF
Remote input	Disabled
Signal Strength Threshold	1.0

7 Specifications

Range

The sensor is able to detect a proper object (see Detectable Objects) at the following ranges, depending on the target:

- 9076 models: 1 m to 24 m (3.3 ft to 78.7 ft)
- 2450 models: 1 m to 40 m (3.3 ft to 131.2 ft)

Detectable Objects

Objects containing metal, water, or similar high-dielectric materials

Operating Principle

Frequency modulated continuous-wave (FMCW) radar

Operating Frequency

24.050-24.250 GHz, ISM Band

Maximum Output Power

- ERP: 3.3 mW, 5 dBm
- EIRP: 100 mW, 20 dBm

Supply Voltage (Vcc)

12 V dc to 30 V dc

Power and Current Consumption, exclusive of load

Normal Run Mode: 1.2 W, Current consumption < 50 mA at 24 V dc

Supply Protection Circuitry

Protected against reverse polarity and transient overvoltages

Delay at Power-up

< 3 seconds

Output Configuration

- Bipolar NPN/PNP output
- Load 1 on pin 2 (white wire) = NPN
- Load 2 on pin 4 (black wire) = PNP

Output Ratings

- 50 mA maximum capability each output
- Saturation:** < 3.5 V at 50 mA
- Off-state leakage current:

Outputs specifications per configuration		
PNP	Output High	$\geq V_{supply} - 2.5 V$
	Output Low	$\leq 2.5 V$ (loads $\leq 70 k\Omega$)
NPN	Output High	$\geq V_{supply} - 2.5 V$ (loads $\leq 70 k\Omega$)
	Output Low	$\leq 2.5 V$

Output Protection

Protected against short circuit conditions

Response Time

Software selectable:

- 50 ms ON/50 ms OFF
- 100 ms ON/100 ms OFF
- 50 ms ON/500 ms OFF
- 50 ms ON/1000 ms OFF

Indicators

Power LED: Green (power ON)

Signal Strength LED: Red, flashes in proportion to signal strength. Steady on at 4x excess gain. Only indicates signal amplitude, not target distance.

Output LEDs: Amber (output energized)
See [Figure 2](#) on page 4

Construction

- Housing:** ABS/polycarbonate
- QD Connector:** Stainless steel
- Mounting Threads:** Stainless steel

Vibration

All models meet IEC 60947-5-2 (Vibration: 10 Hz to 55 Hz; 1 mm peak-to-peak amplitude; 5 minute duration; 30 minutes in each of the three axes at resonant frequency or at 55 Hz)

Shock

All models meet IEC 60947-5-2 (Shock: 30G peak acceleration, 11 ms pulse duration, half sine wave pulse shape)

Operating Temperature

-40 °C to +65 °C (-40 °F to +149 °F)

Environmental Rating

IEC IP67

Connections

Integral 5-pin M12/Euro-style quick disconnect. Models with a quick disconnect require a mating cordset

Certifications



UL Environmental Rating: Type 1

ETSI/EN 300 440
FCC ID: UE3RGAGE1XX
for others, contact Banner Engineering
Country of Origin: USA

7.1 FCC Part 15 and CAN ICES-3 (B)/NMB-3(B)

This device complies with part 15 of the FCC Rules and CAN ICES-3 (B)/NMB-3(B). Operation is subject to the following two conditions:

1. This device may not cause harmful interference, and
2. This device must accept any interference received, including interference that may cause undesired operation.

This equipment has been tested and found to comply with the limits for a Class B digital device, pursuant to part 15 of the FCC Rules and CAN ICES-3 (B)/NMB-3(B). These limits are designed to provide reasonable protection against harmful interference in a residential installation. This equipment generates, uses and can radiate radio frequency energy and, if not installed and used in accordance with the instructions, may cause harmful interference to radio communications. However, there is no guarantee that interference will not occur in a particular installation. If this equipment does cause harmful interference to radio or television reception, which can be determined by turning the equipment off and on, the user is encouraged to try to correct the interference by one or more of the following measures:

- Reorient or relocate the receiving antenna.
- Increase the separation between the equipment and receiver.
- Connect the equipment into an outlet on a circuit different from that to which the receiver is connected.
- Consult the manufacturer.

7.2 PC Requirements

Operating System
Microsoft® Windows® operating system version 10³
Hard Drive Space
130MB

Third-Party Software
.NET version 4.6.2 or higher
USB Port
Available USB port



Important: Administrative rights are required to install the Banner Radar Configuration software.

7.3 Beam Patterns



Note: The effective beam pattern depends on the signal strength threshold and the properties of the target.

7.3 Model -2450

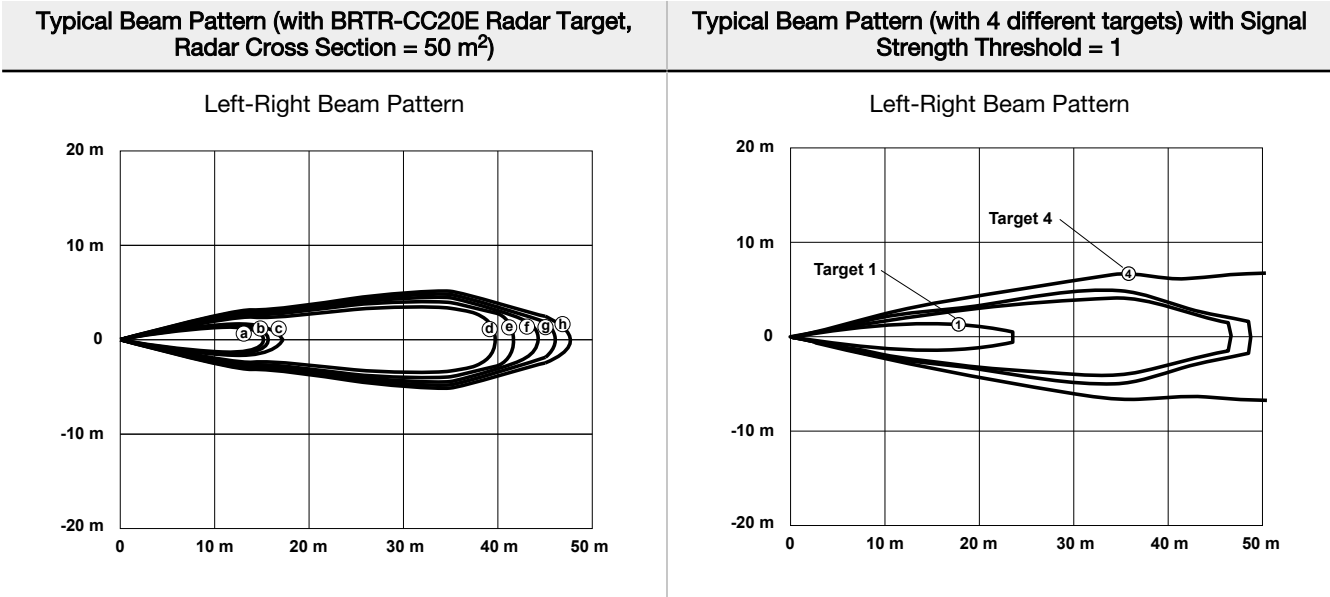

³ Microsoft and Windows are registered trademarks of Microsoft Corporation in the United States and/or other countries.

Typical Beam Pattern (with BRTR-CC20E Radar Target, Radar Cross Section = 50 m²)

Up-Down Beam Pattern

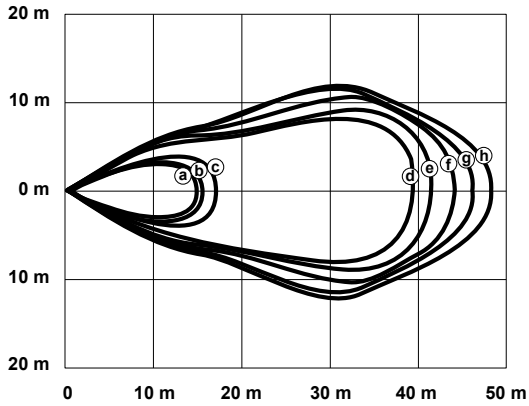

Distance

Beam Pattern	Signal Strength Threshold
a	7.50
b	6.50
c	5.00
d	2.00
e	1.50
f	1.25
g	1.13
h	1.00

Typical Beam Pattern (with 4 different targets) with Signal Strength Threshold = 1

Up-Down Beam Pattern

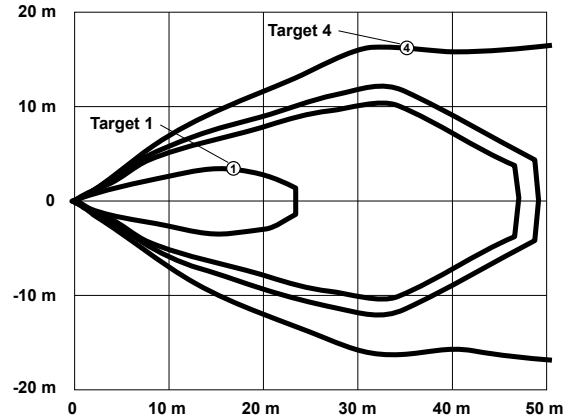

Distance

- 1: Weak Object (Radar cross section = 0.25 m²)
- 2: Car (Radar cross section = 3 m²)
- 3: Large Truck (Radar cross section = 50 m²)
- 4: Passenger Train (Radar cross section = 300 m²)

7.3 Model -9076

Typical Beam Pattern (with BRTR-CC20E Radar Target, Radar Cross Section = 50 m²)

Typical Beam Pattern (with 4 different targets) with Signal Strength Threshold = 1

Left-Right Beam Pattern

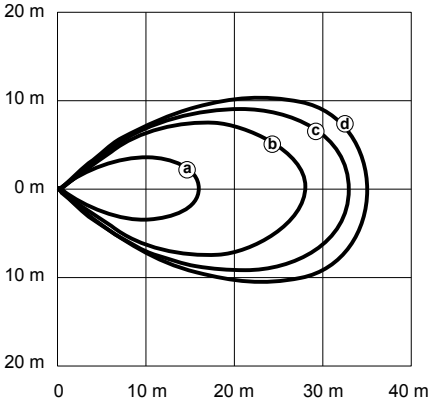

Distance

Beam Pattern	Signal Strength Threshold
a	4.50
b	1.75
c	1.25
d	1.00

Left-Right Beam Pattern

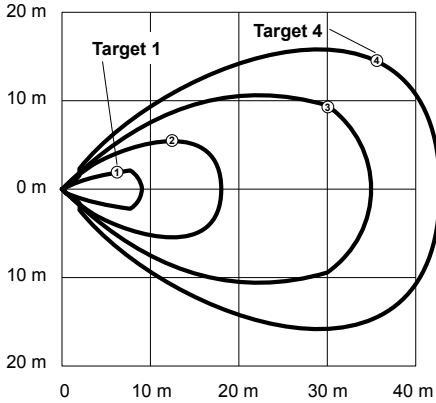

Distance

- 1: Weak Object (Radar cross section = 0.25 m²)
- 2: Car (Radar cross section = 3 m²)
- 3: Large Truck (Radar cross section = 50 m²)
- 4: Passenger Train (Radar cross section = 300 m²)

7.4 Dimensions

All measurements are listed in millimeters [inches], unless noted otherwise.

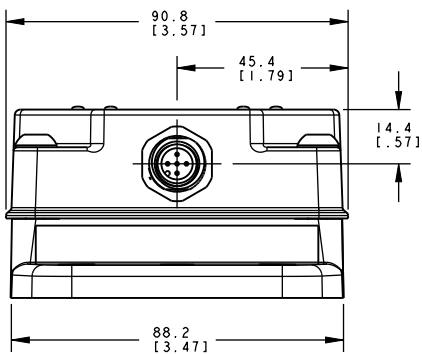
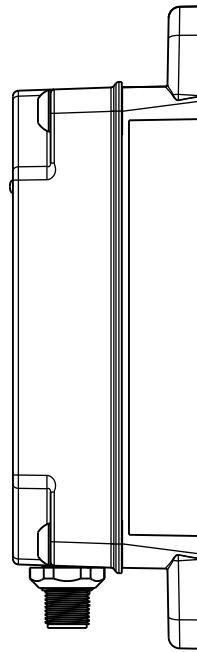
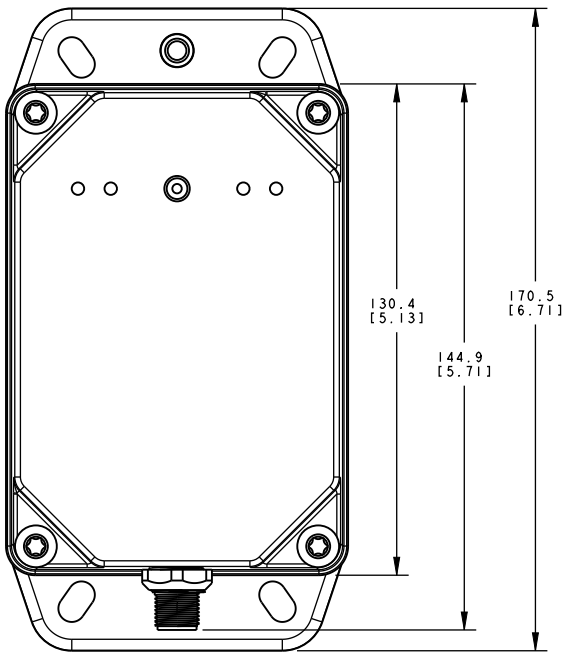
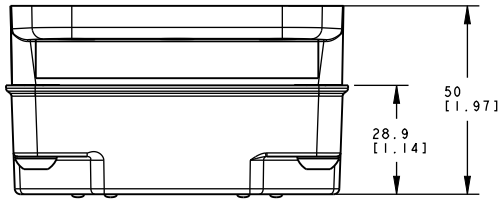

8 Windows

The R-GAGE sensor can be placed behind a glass or a plastic window, but the configuration must be tested and the distance from the sensor to the window must be determined and controlled prior to installation. There is typically a 20% signal reduction when the sensor is placed behind a window.

Polycarbonate at 4 mm thickness performs well in most situations, but the performance depends on filler materials. Thinner (1 to 3 mm) windows have high reflection. The amount of reflection depends on the material, thickness, and distance from the sensor to the window.

Locate the sensor in a position of minimum reflection from the window, which will repeat every 6.1 mm of distance between the sensor and the window. The positions of maximum reflection from the window repeat between the minimums, and decrease in effect until the window is approximately 150 mm (5.9 in) away. Consult the factory for pre-tested window materials which can be used at any distance without issue.

Additionally, the face of the window should be protected from flowing water and ice by use of a flow diverter or hood directly above the window. Falling rain or snow in the air in front of the window, light water mist, or small beads on the face of the window are typically not an issue. However, a thick, continuous surface of water or ice directly on the face of the window can be detected as a dielectric boundary.

9 Update the Software

Use this procedure to update the Banner Radar Configuration Software.

The Banner Radar Configuration Software automatically looks for updated software versions. The symbol  in the lower right corner indicates that a software update is available.

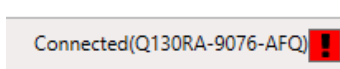



Figure 7. Software Update Available

1. Click  in the lower right corner of the software.
The Banner Radar Configuration Software Update screen displays.

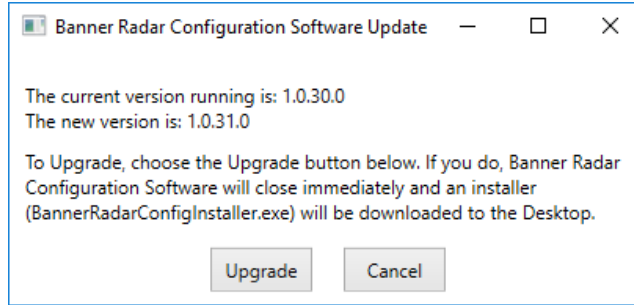

Figure 8. Banner Radar Configuration Software Update Screen

2. Click **Upgrade** to begin the process.
The Banner Radar Configuration Software closes and an installer (BannerRadarConfigInstaller.exe) downloads to the desktop.



Note: If changes have not been written to the sensor, the system asks whether you want to exit the program. Click **No** to stop the update process and return to the Software. Write the changes to the sensor, then return to step 1, above, to update the Software.

3. Navigate to and open the file BannerRadarConfigInstaller.exe.
4. Depending on your system settings, a popup window may appear prompting to allow Banner Radar Configuration Software to make changes to your computer. Click **Yes**.
5. Click **Close** to exit the installer.

The software update is complete.

10 Accessories

10.1 Configuration Tool

MQDC-506-USB

- Pro Converter Cable
- 1.83 m (6 ft) M12/Euro-style quick disconnect to Device and USB to PC
- Required for connection to Pro Editor

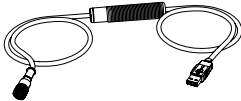

10.2 Quick Disconnect (QD) Cordsets

5-Pin Threaded M12/Euro-Style Cordsets—with Shield				
Model	Length	Style	Dimensions	Pinout (Female)
MQDEC2-506	1.83 m (6 ft)	Straight		<p>1 = Brown 2 = White 3 = Blue 4 = Black 5 = Gray</p>
MQDEC2-515	4.57 m (15 ft)			
MQDEC2-530	9.14 m (30 ft)			
MQDEC2-550	15.2 m (50 ft)			
MQDEC2-506RA	1.83 m (6 ft)	Right-Angle		
MQDEC2-515RA	4.57 m (15 ft)			
MQDEC2-530RA	9.14 m (30 ft)			
MQDEC2-550RA	15.2 m (50 ft)			

10.3 Brackets and Enclosures

SMBQ240SS1

- Sensor mounting plate and pivoting bracket
- Provides ± 20° of tilt in one axis for enhanced sensor alignment
- 12 gauge stainless steel
- Sensor can mount on bracket horizontally or vertically

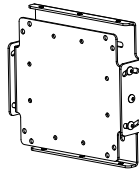

SMBQ240SS2

- Add-on accessory to be used in conjunction with SMBQ240SS1
- Provides ± 20° of tilt in second axis for maximum control of sensor alignment
- 12 gauge stainless steel

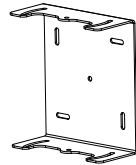

SMBWSQ120

- Rear-Mount Protective Metal Enclosure
- Supports both horizontal and vertical sensor mounting
- Required if the R-GAGE is exposed to rain or snow
- Prevents buildup of water or ice from interfering with sensor performance

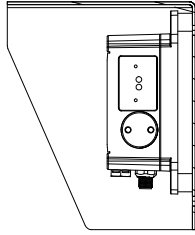

11 Product Support and Maintenance

11.1 Repairs

Contact Banner Engineering for troubleshooting of this device. **Do not attempt any repairs to this Banner device; it contains no field-replaceable parts or components.** If the device, device part, or device component is determined to be defective by a Banner Applications Engineer, they will advise you of Banner's RMA (Return Merchandise Authorization) procedure.



Important: If instructed to return the device, pack it with care. Damage that occurs in return shipping is not covered by warranty.

You may be asked to provide the configuration file and the data log file (.cdf) to aid in troubleshooting.

11.2 Contact Us

Banner Engineering Corporate headquarters is located at:

9714 Tenth Avenue North
 Minneapolis, MN 55441, USA
 Website: www.bannerengineering.com
 Phone: + 1 888 373 6767

For worldwide locations and local representatives, visit www.bannerengineering.com.

11.3 Banner Engineering Corp. Software Copyright Notice

This software is protected by copyright, trade secret, and other intellectual property laws. You are only granted the right to use the software and only for the purposes described by Banner. Banner reserves all other rights in this software. For so long as you have obtained an authorized copy of this software directly from Banner, Banner grants you a limited, nonexclusive, nontransferable right and license to use this software.

You agree not to use, nor permit any third party to use, this software or content in a manner that violates any applicable law, regulation or terms of use under this Agreement. You agree that you will not reproduce, modify, copy, deconstruct, sell, trade or resell this software or make it available to any file-sharing or application hosting service.

Disclaimer of Warranties. Your use of this software is entirely at your own risk, except as described in this agreement. This software is provided "AS-IS." To the maximum extent permitted by applicable law, Banner, its affiliates, and its channel partners disclaim all warranties, expressed or implied, including any warranty that the software is fit for a particular purpose, title, merchantability, data loss, non-interference with or non-infringement of any intellectual property rights, or the accuracy, reliability, quality or content in or linked to the services. Banner and its affiliates and channel partners do not warrant that the services are secure, free from bugs, viruses, interruption, errors, theft or destruction. If the exclusions for implied warranties do not apply to you, any implied warranties are limited to 60 days from the date of first use of this software.

Limitation of Liability and Indemnity. Banner, its affiliates and channel partners are not liable for indirect, special, incidental, punitive or consequential damages, damages relating to corruption, security, loss or theft of data, viruses, spyware, loss of business, revenue, profits, or investment, or use of software or hardware that does not meet Banner minimum systems requirements. The above limitations apply even if Banner and its affiliates and channel partners have been advised of the possibility of such damages. This Agreement sets forth the entire liability of Banner, its affiliates and your exclusive remedy with respect to the software use. You agree to indemnify and hold Banner and its affiliates and channel partners harmless from any and all claims, liability and expenses, including reasonable attorney's fees and costs, arising out of your use of the Services or breach of this Agreement (collectively referred to as "Claims"). Banner reserves the right at its sole discretion and at its own expense, to assume the exclusive defense and control of any Claims. You agree to reasonably cooperate as requested by Banner in defense of any Claims.

11.4 Banner Engineering Corp. Limited Warranty

Banner Engineering Corp. warrants its products to be free from defects in material and workmanship for one year following the date of shipment. Banner Engineering Corp. will repair or replace, free of charge, any product of its manufacture which, at the time it is returned to the factory, is found to have been defective during the warranty period. This warranty does not cover damage or liability for misuse, abuse, or the improper application or installation of the Banner product.

THIS LIMITED WARRANTY IS EXCLUSIVE AND IN LIEU OF ALL OTHER WARRANTIES WHETHER EXPRESS OR IMPLIED (INCLUDING, WITHOUT LIMITATION, ANY WARRANTY OF MERCHANTABILITY OR FITNESS FOR A PARTICULAR PURPOSE), AND WHETHER ARISING UNDER COURSE OF PERFORMANCE, COURSE OF DEALING OR TRADE USAGE.

This Warranty is exclusive and limited to repair or, at the discretion of Banner Engineering Corp., replacement. **IN NO EVENT SHALL BANNER ENGINEERING CORP. BE LIABLE TO BUYER OR ANY OTHER PERSON OR ENTITY FOR ANY EXTRA COSTS, EXPENSES, LOSSES, LOSS OF PROFITS, OR ANY INCIDENTAL, CONSEQUENTIAL OR SPECIAL DAMAGES RESULTING FROM ANY PRODUCT DEFECT OR FROM THE USE OR INABILITY TO USE THE PRODUCT, WHETHER ARISING IN CONTRACT OR WARRANTY, STATUTE, TORT, STRICT LIABILITY, NEGLIGENCE, OR OTHERWISE.**

Banner Engineering Corp. reserves the right to change, modify or improve the design of the product without assuming any obligations or liabilities relating to any product previously manufactured by Banner Engineering Corp. Any misuse, abuse, or improper application or installation of this product or use of the product for personal protection applications when the product is identified as not intended for such purposes will void the product warranty. Any modifications to this product without prior express approval by Banner Engineering Corp will void the product warranties. All specifications published in this document are subject to change; Banner reserves the right to modify product specifications or update documentation at any time. Specifications and product information in English supersede that which is provided in any other language. For the most recent version of any documentation, refer to: www.bannerengineering.com.

For patent information, see www.bannerengineering.com/patents.

Index

D

delay
 off 10
 on 10
distance 10

H

hysteresis 10

N

NC 10
NO 10
normally closed 10
normally open 10

O

off delay 10

on delay 10
output filtering 10
output LED 4
output status 10

P

PC requirements 17
power LED 4

R

range
 X 9
 Y 9

S

signal strength 10
signal strength LED 4

software 4, 22

T

total response time 10

X

X range 9

Y

Y range 9

Z

zone 10