

NPN Silicon Darlington Transistors

BCP 29
BCP 49

- For general AF applications
- High collector current
- High current gain
- Complementary types: BCP 28/48 (PNP)

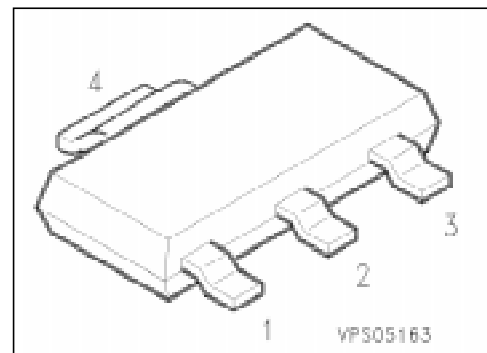

Type	Marking	Ordering Code (tape and reel)	Pin Configuration	Package ¹⁾
BCP 29 BCP 49	BCP 29 BCP 49	Q62702-C2136 Q62702-C2137		SOT-223

Maximum Ratings

Parameter	Symbol	Values		Unit
		BCP 29	BCP 49	
Collector-emitter voltage	V_{CE0}	30	60	V
Collector-base voltage	V_{CB0}	40	80	
Emitter-base voltage	V_{EB0}	10	10	
Collector current	I_C	500		mA
Peak collector current	I_{CM}	800		
Base current	I_B	100		
Peak base current	I_{BM}	200		
Total power dissipation, $T_S = 124\text{ °C}^2$)	P_{tot}	1.5		W
Junction temperature	T_j	150		°C
Storage temperature range	T_{stg}	- 65 ... + 150		

Thermal Resistance

Junction - ambient ²⁾	$R_{th\ JA}$	≤ 75	K/W
Junction - soldering point	$R_{th\ JS}$	≤ 17	

¹⁾ For detailed information see chapter Package Outlines.

²⁾ Package mounted on epoxy pcb 40 mm × 40 mm × 1.5 mm/6 cm² Cu.

Electrical Characteristics

at $T_A = 25\text{ °C}$, unless otherwise specified.

Parameter	Symbol	Values			Unit
		min.	typ.	max.	

DC characteristics

Collector-emitter breakdown voltage $I_C = 1\text{ mA}, I_B = 0$	$V_{(BR)CE0}$				V
BCP 29	30	–	–		
BCP 49	60	–	–		
Collector-base breakdown voltage $I_C = 100\text{ }\mu\text{A}, I_B = 0$	$V_{(BR)CB0}$				
BCP 29	40	–	–		
BCP 49	80	–	–		
Emitter-base breakdown voltage $I_E = 10\text{ }\mu\text{A}, I_C = 0$	$V_{(BR)EB0}$	10	–	–	
Collector-base cutoff current $V_{CB} = 30\text{ V}, I_E = 0$	I_{CB0}	–	–	100	nA
$V_{CB} = 60\text{ V}, I_E = 0$	BCP 49	–	–	100	nA
$V_{CB} = 30\text{ V}, I_E = 0, T_A = 150\text{ °C}$	BCP 29	–	–	10	μA
$V_{CB} = 60\text{ V}, I_E = 0, T_A = 150\text{ °C}$	BCP 49	–	–	10	μA
Emitter-base cutoff current $V_{EB} = 4\text{ V}, I_C = 0$	I_{EB0}	–	–	100	nA
DC current gain ¹⁾ $I_C = 100\text{ }\mu\text{A}, V_{CE} = 1\text{ V}$	h_{FE}	4000	–	–	–
BCP 49	2000	–	–		
$I_C = 10\text{ mA}, V_{CE} = 5\text{ V}$	BCP 29	10000	–	–	
BCP 49	4000	–	–		
$I_C = 100\text{ mA}, V_{CE} = 5\text{ V}$	BCP 29	20000	–	–	
BCP 49	10000	–	–		
$I_C = 500\text{ mA}, V_{CE} = 5\text{ V}$	BCP 29	4000	–	–	
BCP 49	2000	–	–		
Collector-emitter saturation voltage $I_C = 100\text{ mA}, I_B = 0.1\text{ mA}$	V_{CEsat}	–	–	1.0	V
Base-emitter saturation voltage $I_C = 100\text{ mA}, I_B = 0.1\text{ mA}$	V_{BEsat}	–	–	1.5	

¹⁾ Pulse test conditions: $t \leq 300\text{ }\mu\text{s}, D = 2\%$.

Electrical Characteristics

at $T_A = 25\text{ }^\circ\text{C}$, unless otherwise specified.

Parameter	Symbol	Values			Unit
		min.	typ.	max.	

AC characteristics

Transition frequency $I_C = 50\text{ mA}$, $V_{CE} = 5\text{ V}$, $f = 100\text{ MHz}$	f_t	–	200	–	MHz
Output capacitance $V_{CB} = 10\text{ V}$, $f = 1\text{ MHz}$	C_{obo}	–	6.5	–	pF

Total power dissipation $P_{tot} = f(T_A^*; T_S)$

* Package mounted on epoxy

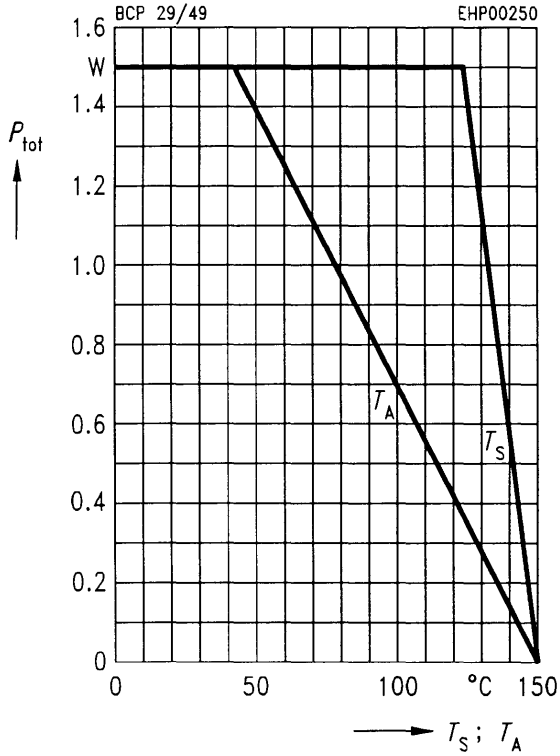

Collector cutoff current $I_{CB0} = f(T_A)$

$V_{CB} = V_{CE\ max}$

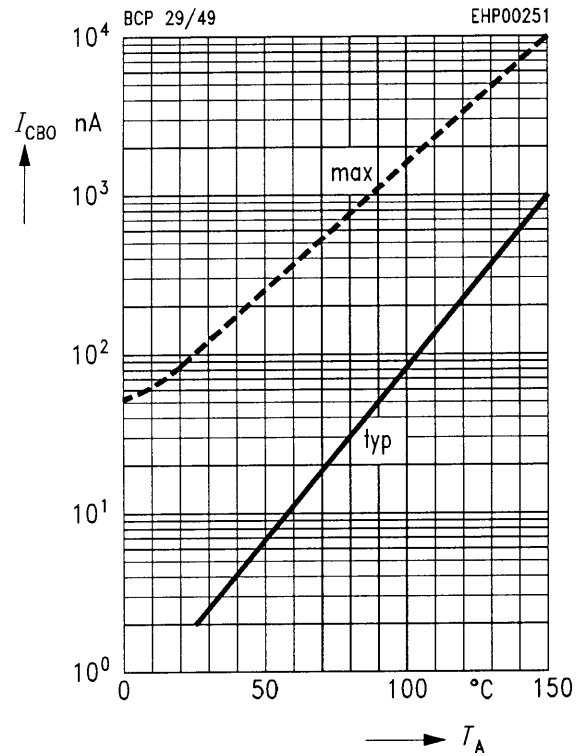

Transition frequency $f_T = f(I_C)$

$V_{CE} = 5\ V$

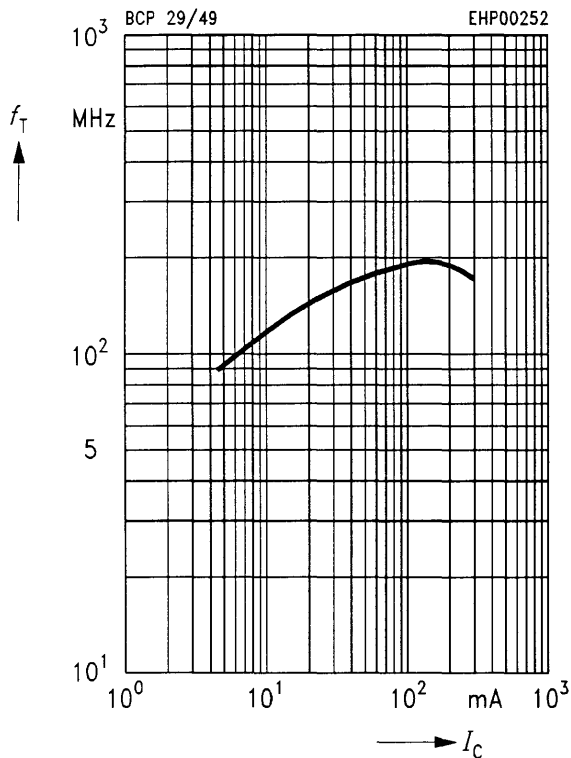

Permissible pulse load $P_{tot\ max}/P_{tot\ DC} = f(t_p)$

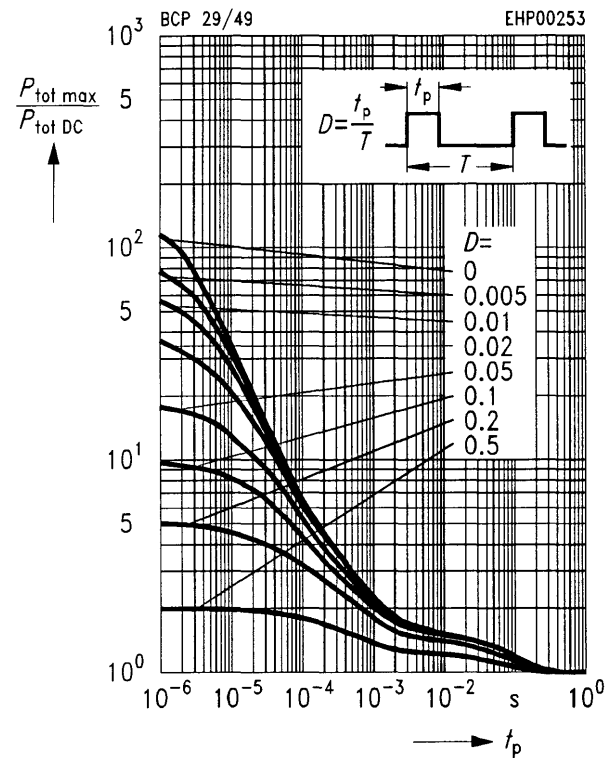

DC current gain $h_{FE} = f(I_C)$

$V_{CE} = 10\text{ V}$

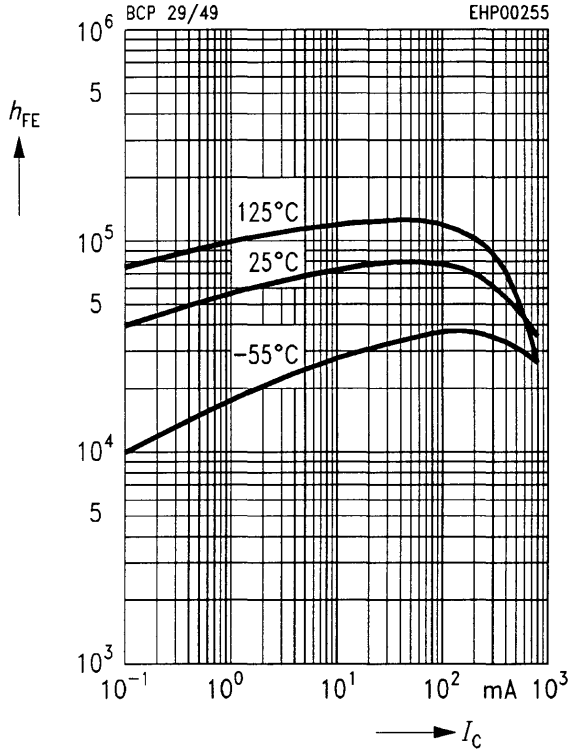

Collector-emitter saturation voltage $I_C = f(V_{CEsat})$

$I_C = f(V_{CEsat})$

$h_{FE} = 1000$

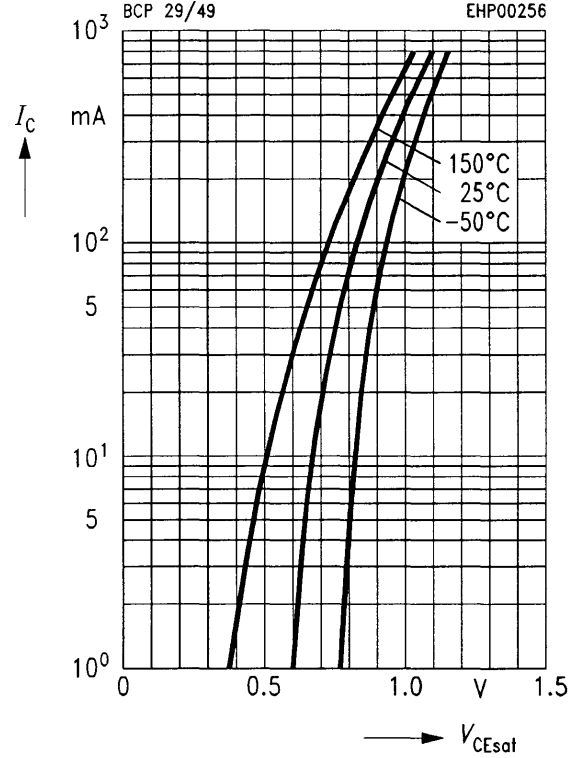

Collector-base capacitance $C_{CB0} = f(V_{CB0})$

Emitter-base capacitance $C_{EB0} = f(V_{EB0})$

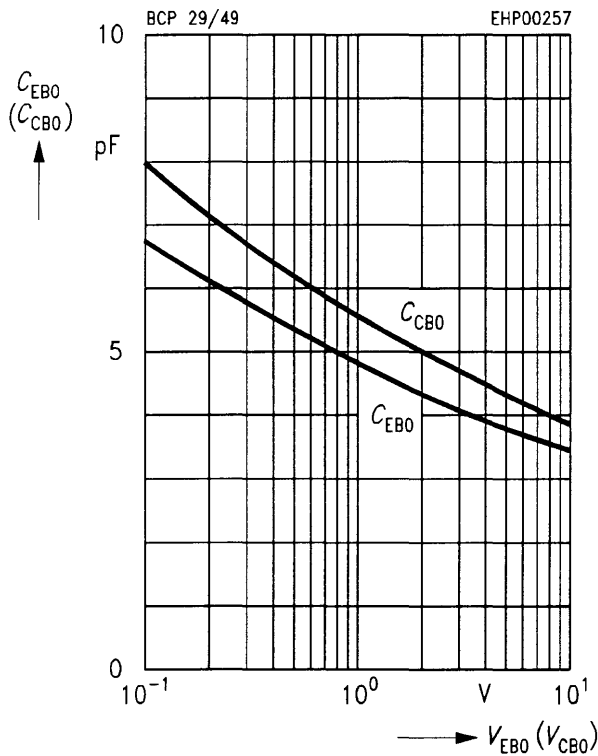

Base-emitter saturation voltage $I_C = f(V_{BEsat})$

$I_C = f(V_{BEsat})$

$h_{FE} = 1000$

