

# NPN-Silizium-Fototransistor im SMT TOPLED<sup>®</sup>-Gehäuse Silicon NPN Phototransistor in SMT TOPLED<sup>®</sup>-Package

## SFH 320 SFH 320 FA

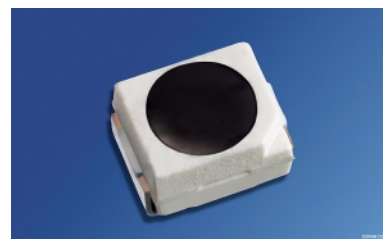

SFH 320



SFH 320 FA

### Wesentliche Merkmale

- Speziell geeignet für Anwendungen im Bereich von 380 nm bis 1150 nm (SFH 320) und bei 880 nm (SFH 320 FA)
- Hohe Linearität
- P-LCC-2 Gehäuse
- Gruppierbar lieferbar
- Für alle Lötverfahren geeignet

### Anwendungen

- Miniaturlichtschranken für Gleich- und Wechsellichtbetrieb
- Lochstreifenleser
- Industrieelektronik
- „Messen/Steuern/Regeln“

### Features

- Especially suitable for applications from 380 nm to 1150 nm (SFH 320) and of 880 nm (SFH 320 FA)
- High linearity
- P-LCC-2 package
- Available in groups
- Suitable for all soldering methods

### Applications

- Miniature photointerrupters
- Punched tape readers
- Industrial electronics
- For control and drive circuits

Typ Type	Bestellnummer Ordering Code	Typ Type	Bestellnummer Ordering Code
SFH 320	Q62702-P0961	SFH 320 FA	Q62702-P0988
SFH 320-3	Q62702-P390	SFH 320 FA-3	Q62702-P393
SFH 320-3/-4	Q62702-P3602	SFH 320 FA-3/-4	Q62702-P3601
SFH 320-4	Q62702-P1606	SFH 320 FA-4	Q62702-P1607

**Grenzwerte**  
**Maximum Ratings**

Bezeichnung Parameter	Symbol Symbol	Wert Value	Einheit Unit
Betriebs- und Lagertemperatur Operating and storage temperature range	$T_{op}; T_{stg}$	- 40 ... + 100	°C
Kollektor-Emitterspannung Collector-emitter voltage	$V_{CE}$	35	V
Kollektorstrom Collector current	$I_C$	15	mA
Kollektorspitzenstrom, $\tau < 10 \mu s$ Collector surge current	$I_{CS}$	75	mA
Verlustleistung, $T_A = 25 \text{ °C}$ Total power dissipation	$P_{tot}$	165	mW
Wärmewiderstand für Montage auf PC-Board Thermal resistance for mounting on pcb	$R_{thJA}$	450	K/W

**Kennwerte** ( $T_A = 25\text{ °C}$ ,  $\lambda = 950\text{ nm}$ )

**Characteristics**

Bezeichnung Parameter	Symbol Symbol	Wert Value		Einheit Unit
		SFH 320	SFH 320 FA	
Wellenlänge der max. Fotoempfindlichkeit Wavelength of max. sensitivity	$\lambda_{S\text{ max}}$	860	900	nm
Spektraler Bereich der Fotoempfindlichkeit $S = 10\%$ von $S_{\text{max}}$ Spectral range of sensitivity $S = 10\%$ of $S_{\text{max}}$	$\lambda$	380 ... 1150	730 ... 1120	nm
Bestrahlungsempfindliche Fläche ( $\varnothing 240\text{ }\mu\text{m}$ ) Radiant sensitive area	$A$	0.045	0.045	mm <sup>2</sup>
Abmessung der Chipfläche Dimensions of chip area	$L \times B$ $L \times W$	$0.45 \times 0.45$	$0.45 \times 0.45$	mm $\times$ mm
Abstand Chipoberfläche zu Gehäuseoberfläche Distance chip front to case surface	$H$	0.5 ... 0.7	0.5 ... 0.7	mm
Halbwinkel Half angle	$\varphi$	$\pm 60$	$\pm 60$	Grad deg.
Kapazität, $V_{\text{CE}} = 0\text{ V}$ , $f = 1\text{ MHz}$ , $E = 0$ Capacitance	$C_{\text{CE}}$	5.0	5.0	pF
Dunkelstrom Dark current $V_{\text{CE}} = 25\text{ V}$ , $E = 0$	$I_{\text{CEO}}$	1 ( $\leq 200$ )	1 ( $\leq 200$ )	nA

Die Fototransistoren werden nach ihrer Fotoempfindlichkeit gruppiert und mit arabischen Ziffern gekennzeichnet.

The phototransistors are grouped according to their spectral sensitivity and distinguished by arabian figures.

Bezeichnung Parameter	Symbol Symbol	Wert Value				Einheit Unit
		SFH 320/FA	-2	-3	-4	
Fotostrom, $\lambda = 950 \text{ nm}$ Photocurrent $E_e = 0.1 \text{ mW/cm}^2, V_{CE} = 5 \text{ V}$ <b>SFH 320:</b> $E_v = 1000 \text{ lx, Normlicht/standard light A, } V_{CE} = 5 \text{ V}$	$I_{PCE}$	$\geq 16$	16 ... 32	25 ... 50	40 ... 80	$\mu\text{A}$
	$I_{PCE}$	–	420	650	1000	$\mu\text{A}$
Anstiegszeit/Abfallzeit Rise and fall time $I_C = 1 \text{ mA, } V_{CC} = 5 \text{ V, } R_L = 1 \text{ k}\Omega$	$t_r, t_f$	7	6	7	8	$\mu\text{s}$
Kollektor-Emitter-Sättigungsspannung Collector-emitter saturation voltage $I_C = I_{PCEmin}^{1)} \times 0.3,$ $E_e = 0.1 \text{ mW/cm}^2$	$V_{CEsat}$	150	150	150	150	mV

1)  $I_{PCEmin}$  ist der minimale Fotostrom der jeweiligen Gruppe.

1)  $I_{PCEmin}$  is the min. photocurrent of the specified group.

**Directional Characteristics**

$S_{rel} = f(\varphi)$

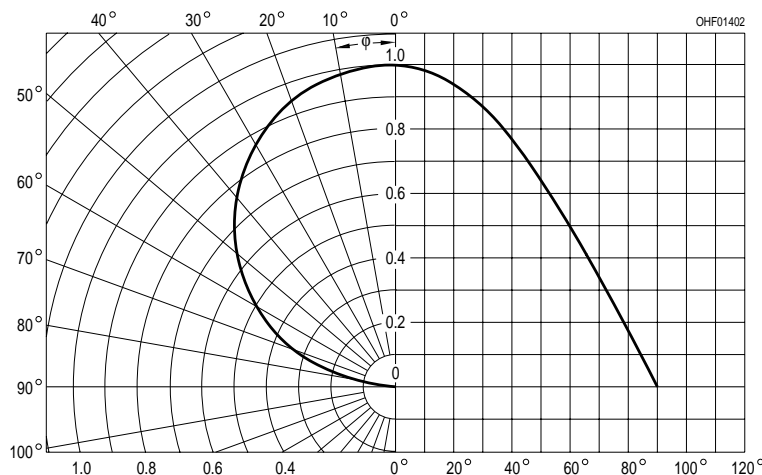

**Relative Spectral Sensitivity, SFH 320**  $S_{rel} = f(\lambda)$

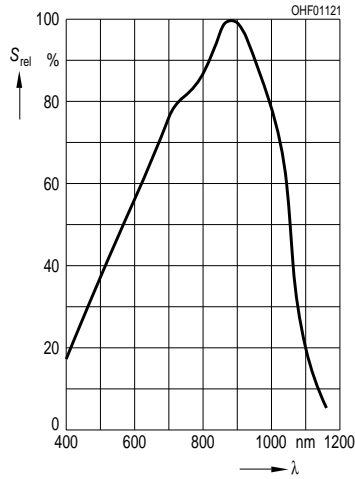

**Relative Spectral Sensitivity, SFH 320 FA**  $S_{rel} = f(\lambda)$

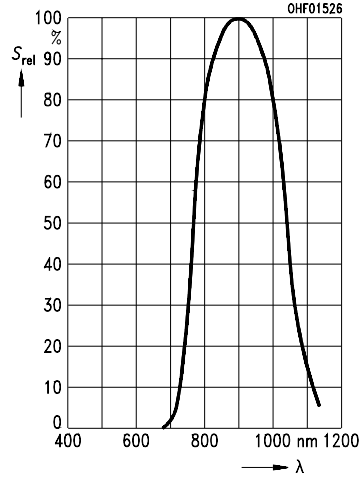

**Photocurrent**  $I_{PCE} = f(E_e), V_{CE} = 5 V$

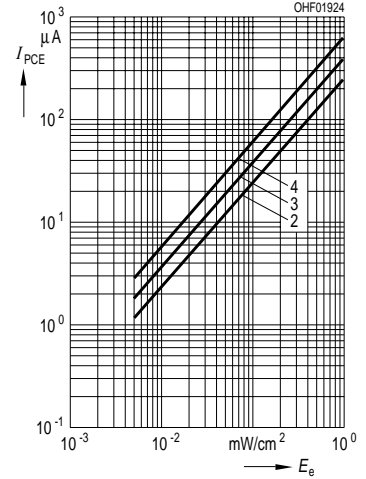

**Total Power Dissipation**

$P_{tot} = f(T_A)$

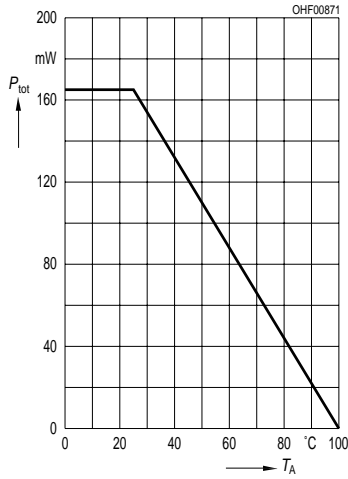

**Photocurrent**

$I_{PCE} = f(V_{CE}), E_e = \text{Parameter}$

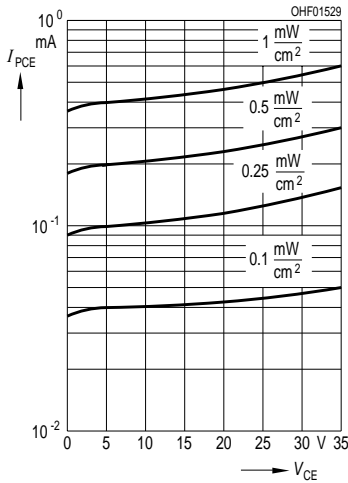

**Dark Current**

$I_{CEO} = f(V_{CE}), E = 0$

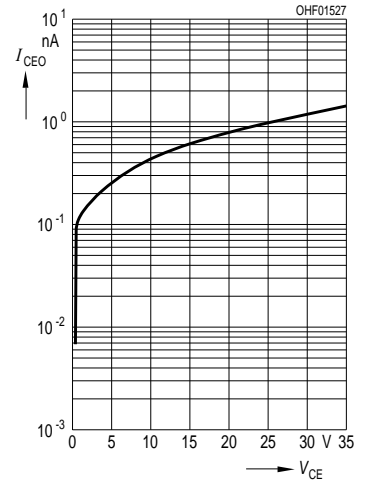

**Dark Current**

$I_{CEO} = f(T_A), V_{CE} = 5 V, E = 0$

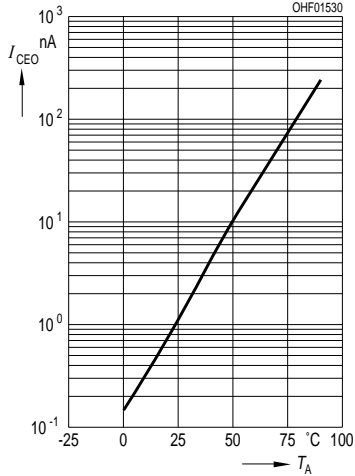

**Capacitance**

$C_{CE} = f(V_{CE}), f = 1 \text{ MHz}, E = 0$

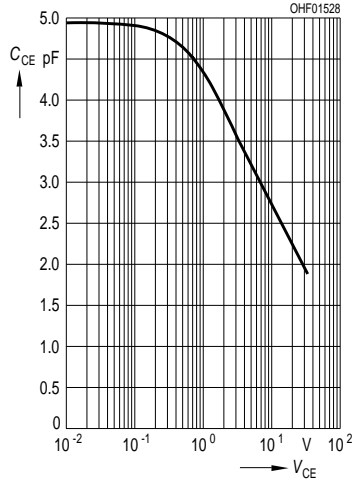

**Photocurrent**

$I_{PCE} / I_{PCE25^\circ} = f(T_A), V_{CE} = 5 V$

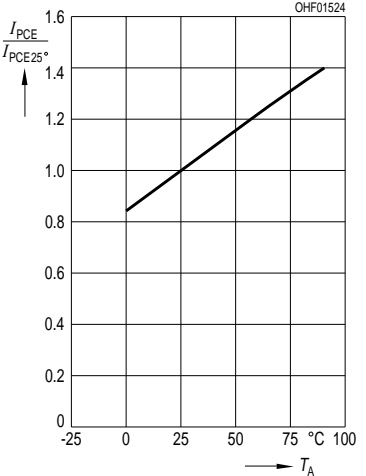

Maßzeichnung  
Package Outlines

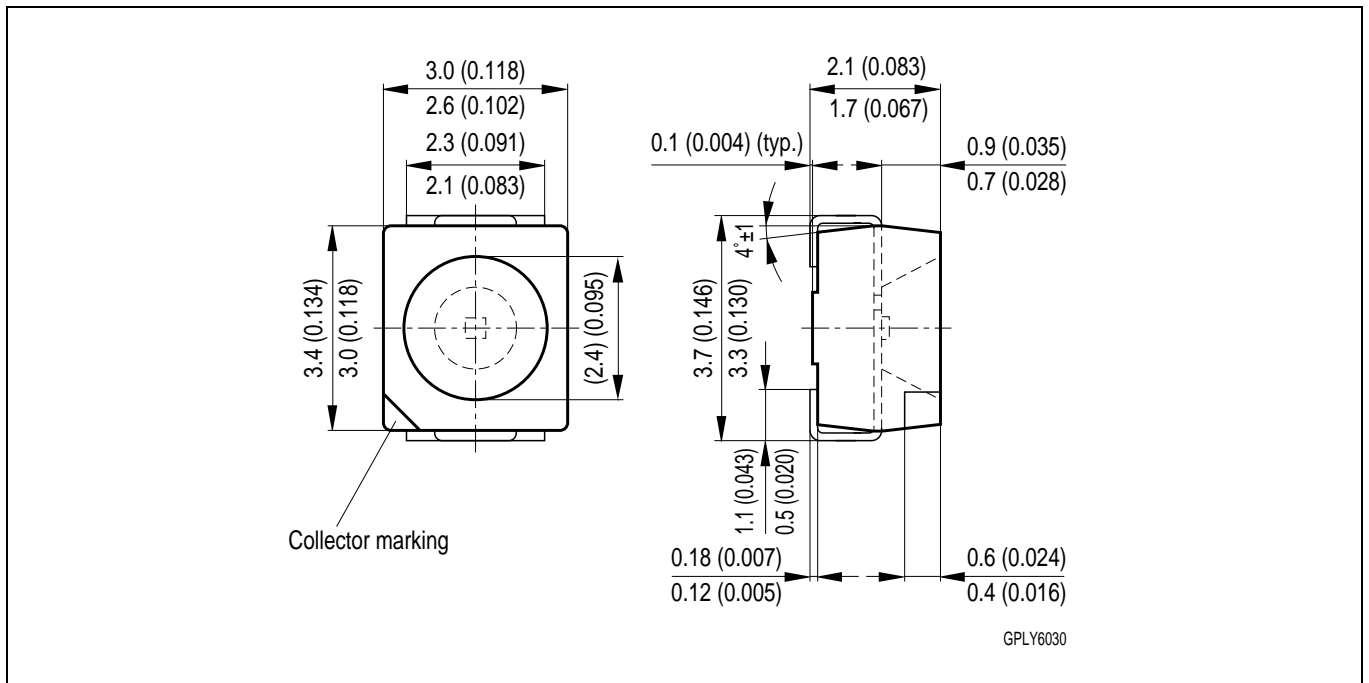

Maße werden wie folgt angegeben: mm (inch) / Dimensions are specified as follows: mm (inch).

## Löthinweise Soldering Conditions

Bauform Types	Tauch-, Schwall- und Schleplötung Dip, Wave and Drag Soldering			Reflowlötung Reflow Soldering	
	Lötbad- temperatur  Temperature of the Soldering Bath	Maximal zulässige Lötzeit  Max. Perm. Soldering Time	Abstand Lötstelle – Gehäuse  Distance between Solder Joint and Case	Lötzonen- temperatur  Temperature of Soldering Zone	Maximale Durchlaufzeit  Max. Transit Time
TOPLED	260 °C	10 s	–	245 °C	10 s

Zusätzliche Informationen über allgemeine Lötbedingungen erhalten Sie auf Anfrage.

For additional information on general soldering conditions please contact us.

Published by OSRAM Opto Semiconductors GmbH & Co. OHG  
Wernerwerkstrasse 2, D-93049 Regensburg

© All Rights Reserved.

### Attention please!

The information describes the type of component and shall not be considered as assured characteristics. Terms of delivery and rights to change design reserved. Due to technical requirements components may contain dangerous substances. For information on the types in question please contact our Sales Organization.

### Packing

Please use the recycling operators known to you. We can also help you – get in touch with your nearest sales office. By agreement we will take packing material back, if it is sorted. You must bear the costs of transport. For packing material that is returned to us unsorted or which we are not obliged to accept, we shall have to invoice you for any costs incurred.

**Components used in life-support devices or systems must be expressly authorized for such purpose!** Critical components <sup>1</sup>, may only be used in life-support devices or systems <sup>2</sup> with the express written approval of OSRAM OS.

<sup>1</sup> A critical component is a component used in a life-support device or system whose failure can reasonably be expected to cause the failure of that life-support device or system, or to affect its safety or effectiveness of that device or system.

<sup>2</sup> Life support devices or systems are intended (a) to be implanted in the human body, or (b) to support and/or maintain and sustain human life. If they fail, it is reasonable to assume that the health of the user may be endangered.