

SMT Multi TOPLED®

SFH 331



Wesentliche Merkmale

- SMT-Gehäuse mit rotem Sender (635 nm) und Si-Fototransistor
- Geeignet für SMT-Bestückung
- Gegurtet lieferbar
- Sender und Empfänger getrennt ansteuerbar
- Geeignet für IR-Reflow Löten

Anwendungen

- Datenübertragung
- Wegfahrsperr
- Infrarotschnittstelle

Features

- SMT package with red emitter (635 nm) and Si-phototransistor
- Suitable for SMT assembly
- Available on tape and reel
- Emitter and detector can be controlled separately
- Suitable for IR-reflow soldering

Applications

- Data transmission
- Lock bar
- Infrared interface

Typ Type	Bestellnummer Ordering Code
SFH 331-JK	Q62702-P1634

Grenzwerte
Maximum Ratings

Bezeichnung Parameter	Symbol Symbol	Wert Value		Einheit Unit
		LED	Transistor	
Betriebstemperatur Operating temperature range	T_{op}	- 40 ... + 100	- 40 ... + 100	°C
Lagertemperatur Storage temperature range	T_{stg}	- 40 ... + 100	- 40 ... + 100	°C
Sperrschichttemperatur Junction temperature	T_j	+ 100	+ 100	°C
Durchlaßstrom (LED) Forward current (LED)	I_F	30	–	mA
Kollektorstrom (Transistor) Collector current (Transistor)	I_C	–	15	mA
Stoßstrom Surge current $t \leq 10 \mu s, D = 0.005$	I_{FM}	500	75	mA
Sperrspannung (LED) Reverse voltage (LED)	V_R	5	–	V
Kollektor-Emitter Spannung (Transistor) Collector-emitter voltage (Transistor)	V_{CE}	–	35	V
Verlustleistung Power dissipation	P_{tot}	100	165	mW
Wärmewiderstand Sperrschicht/Umgebung Thermal resistance junction/ambient Montage auf PC-Board ¹⁾ (Padgröße $\geq 16 \text{ mm}^2$) mounting on pcb ¹⁾ (pad size $\geq 16 \text{ mm}^2$)	R_{thJA}	450	450	K/W
Sperrschicht / Lötstelle junction / soldering joint	R_{thJS}	350	–	K/W

¹⁾ PC-board: G30/FR4

Note: Die angegebenen Grenzwerte gelten für den Chip, für den sie angegeben sind, unabhängig vom Betriebszustand des anderen.

The stated max. ratings refer to the specified chip regardless of the operating status of the other one.

Kennwerte LED ($T_A = 25\text{ °C}$)

Characteristics LED

Bezeichnung Parameter		Symbol Symbol	Wert Value	Einheit Unit
Wellenlänge des emittierten Lichtes Wavelength at peak emission $I_F = 10\text{ mA}$	(typ.) (typ.)	λ_{peak}	635	nm
Dominantwellenlänge Dominant wavelength $I_F = 10\text{ mA}$	(typ.) (typ.)	λ_{dom}	628	nm
Spektrale Bandbreite bei 50% von $I_{\text{rel max}}$ Spectral bandwidth at 50% of $I_{\text{rel max}}$ $I_F = 10\text{ mA}$	(typ.) (typ.)	$\Delta\lambda$	45	nm
Abstrahlwinkel bei 50% von I_V (Vollwinkel) Viewing angle at 50% of I_V		2φ	120	Grad deg.
Durchlaßspannung Forward voltage $I_F = 10\text{ mA}$	(typ.) (max.)	V_F V_F	2.0 2.6	V V
Sperrstrom Reverse current $V_R = 5\text{ V}$	(typ.) (max)	I_R I_R	0.01 10	μA μA
Kapazität, Capacitance $V_R = 0\text{ V}, f = 1\text{ MHz}$	(typ.)	C_o	12	pF
Schaltzeiten: Switching times: I_V from 10% to 90% I_V from 90% to 10% $I_F = 100\text{ mA}, t_p = 10\text{ }\mu\text{s}, R_L = 50\text{ }\Omega$	(typ.) (typ.)	t_r t_f	300 150	ns ns
Lichtstärke (Gruppe JK) Luminous intensity (group JK) $I_F = 10\text{ mA}$	(typ.)	I_V	6 (4.0 ... 12.5)	mcd

Kennwerte Fototransistor ($T_A = 25\text{ °C}$, $\lambda = 950\text{ nm}$)
Characteristics Phototransistor

Bezeichnung Parameter	Symbol Symbol	Wert Value	Einheit Unit
Wellenlänge der max. Fotoempfindlichkeit Wavelength of max. sensitivity	$\lambda_{S\text{ max}}$	860	nm
Spektraler Bereich der Fotoempfindlichkeit $S = 10\%$ von S_{max} Spectral range of sensitivity $S = 10\%$ of S_{max}	λ	380 ... 1150	nm
Bestrahlungsempfindliche Fläche ($\varnothing 240\text{ }\mu\text{m}$) Radiant sensitive area ($\varnothing 240\text{ }\mu\text{m}$)	A	0.045	mm^2
Abmessungen der Chipfläche Dimensions of chip area	$L \times B$	0.45×0.45	$\text{mm} \times \text{mm}$
Abstand Chipoberfläche zu Gehäuseoberfläche Distance chip surface to case surface	H	0.5 ... 0.7	mm
Halbwinkel Half angle	φ	± 60	Grad deg.
Kapazität Capacitance $V_{\text{CE}} = 0\text{ V}$, $f = 1\text{ MHz}$, $E = 0$	C_{CE}	5.0	pF
Dunkelstrom Dark current $V_{\text{CE}} = 25\text{ V}$, $E = 0$	I_{CEO}	1 (≤ 200)	nA
Fotostrom Photocurrent $E_e = 0.1\text{ mW/cm}^2$, $V_{\text{CE}} = 5\text{ V}$	I_{PCE}	≥ 16	μA
Anstiegszeit/Abfallzeit Rise time/Fall time $I_{\text{C}} = 1\text{ mA}$, $V_{\text{CC}} = 5\text{ V}$, $R_{\text{L}} = 1\text{ k}\Omega$	t_r , t_f	7	μs
Kollektor-Emitter-Sättigungsspannung Collector-emitter saturation voltage $I_{\text{C}} = 5\text{ }\mu\text{A}$, $E_e = 0.1\text{ mW/cm}^2$	V_{CEsat}	150	mV

LED Radiation Characteristics $I_{rel} = f(\varphi)$

Phototransistor Directional Characteristics $S_{rel} = f(\varphi)$

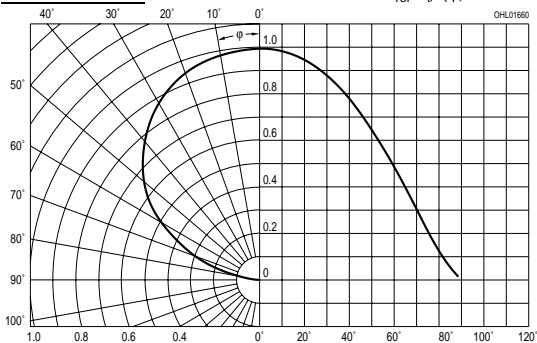

LED Relative Spectral Emission $I_{rel} = f(\lambda)$, $T_A = 25\text{ }^\circ\text{C}$, $I_F = 20\text{ mA}$

$V(\lambda) = \text{Standard Eye Response Curve}$

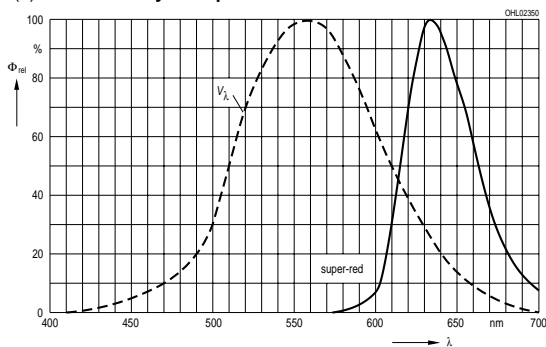

Forward Current

$I_F = f(V_F), T_A = 25\text{ }^\circ\text{C}$

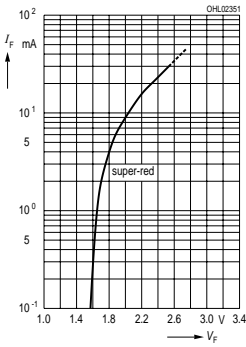

Rel. Luminous Intensity

$I_V/I_{V(10\text{mA})} = f(I_F), T_A = 25\text{ }^\circ\text{C}$

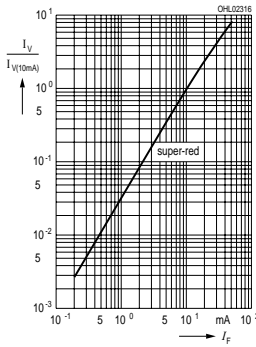

Perm. Pulse Handling Capability

$I_F = f(t_p), \text{ duty cycle } D = \text{parameter}, T_A = 25\text{ }^\circ\text{C}$

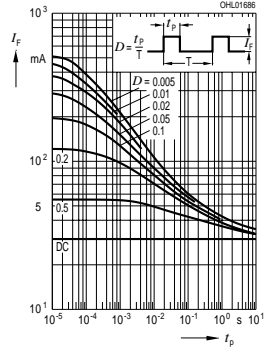

Max. Permissible Forward Current

$I_F = f(T_A)$

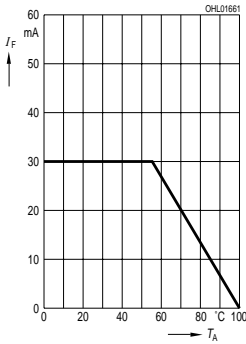

Wavelength at Peak Emission

$\lambda_{\text{peak}} = f(T_A), I_F = 20\text{ mA}$

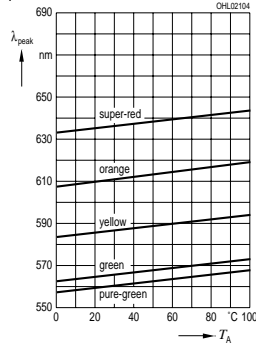

Dominant Wavelength

$\lambda_{\text{dom}} = f(T_A), I_F = 20\text{ mA}$

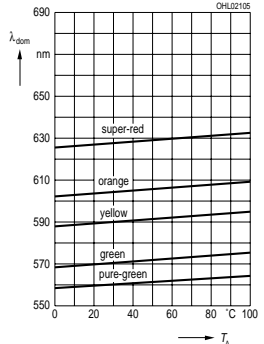

Forward Current

$V_F = f(T_A), I_F = 10\text{ mA}$

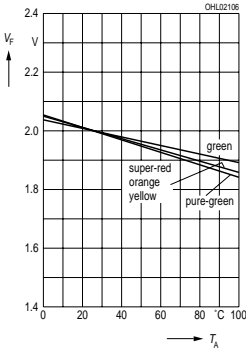

Rel. Luminous Intensity

$I_V/I_{V(25\text{ }^\circ\text{C})} = f(T_A), I_F = 10\text{ mA}$

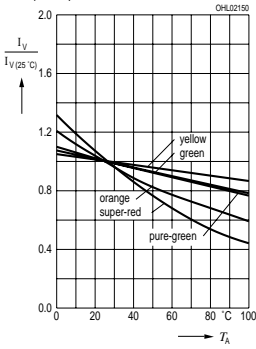

Phototransistor

Rel. Spectral Sensitivity $S_{rel} = f(\lambda)$

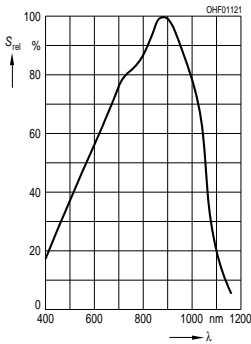

Photocurrent

$I_{PCE} = f(V_{CE}), E_e = \text{Parameter}$

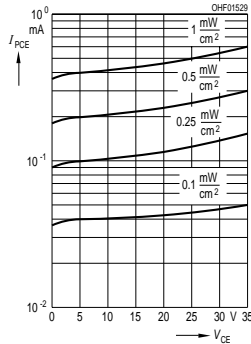

Dark Current

$I_{CEO} = f(V_{CE}), E = 0$

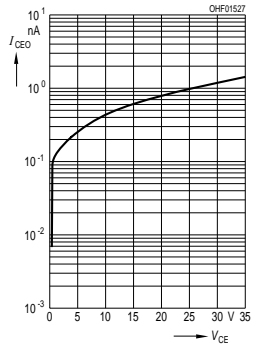

Total Power Dissipation

$P_{tot} = f(T_A)$

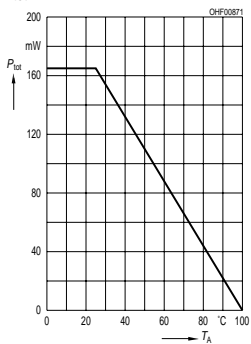

Capacitance

$C_{CE} = f(V_{CE}), f = 1 \text{ MHz}, E = 0$

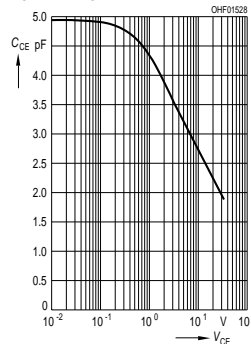

Photocurrent

$I_{PCE}/I_{PCE25^\circ} = f(T_A), V_{CE} = 5 \text{ V}$

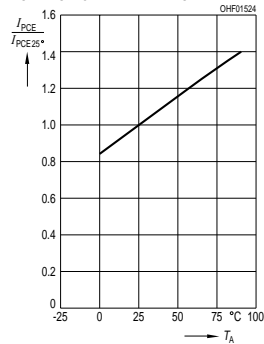

Dark Current

$I_{CEO} = f(T_A), V_{CE} = 5 \text{ V}, E = 0$

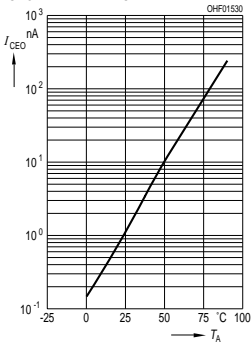

Photocurrent

$I_{PCE} = f(E_e), V_{CE} = 5 \text{ V}$

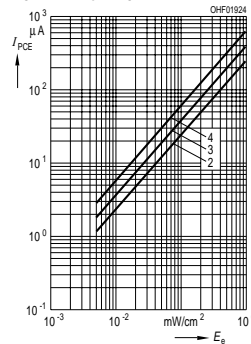

Maßzeichnung Package Outlines

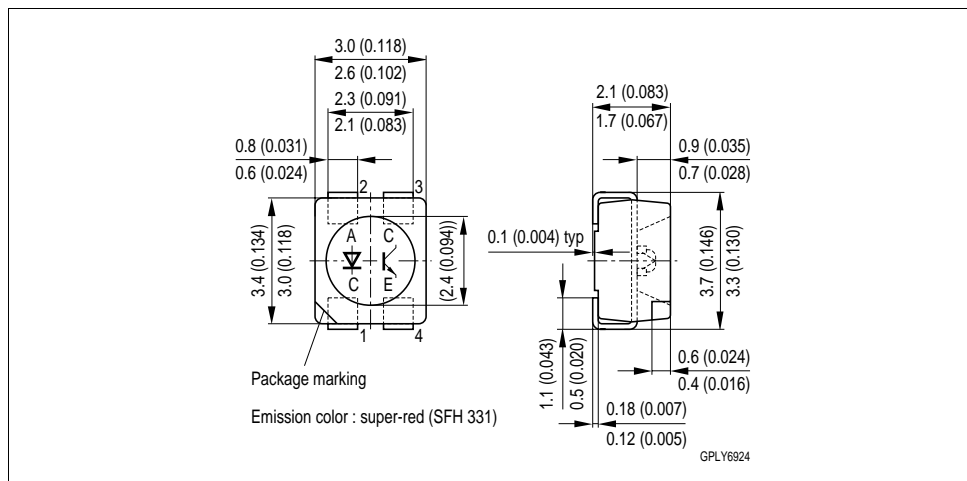

Maße werden wie folgt angegeben: mm (inch) / Dimensions are specified as follows: mm (inch).

Published by **OSRAM Opto Semiconductors GmbH & Co. OHG**
 Wernerwerkstrasse 2, D-93049 Regensburg
 © All Rights Reserved.

Attention please!

The information describes the type of component and shall not be considered as assured characteristics. Terms of delivery and rights to change design reserved. Due to technical requirements components may contain dangerous substances. For information on the types in question please contact our Sales Organization.

Packing

Please use the recycling operators known to you. We can also help you – get in touch with your nearest sales office. By agreement we will take packing material back, if it is sorted. You must bear the costs of transport. For packing material that is returned to us unsorted or which we are not obliged to accept, we shall have to invoice you for any costs incurred.

Components used in life-support devices or systems must be expressly authorized for such purpose! Critical components¹, may only be used in life-support devices or systems² with the express written approval of OSRAM OS.

¹ A critical component is a component used in a life-support device or system whose failure can reasonably be expected to cause the failure of that life-support device or system, or to affect its safety or effectiveness of that device or system.

² Life support devices or systems are intended (a) to be implanted in the human body, or (b) to support and/or maintain and sustain human life. If they fail, it is reasonable to assume that the health of the user may be endangered.