

Schnelle IR-Lumineszenzdiode (950 nm) im SMR®-Gehäuse High-Speed Infrared Emitter (950 nm) in SMR® Package

SFH 4500
SFH 4505



SFH 4500



SFH 4505

Wesentliche Merkmale

- Hohe Pulsleistung und hoher Gesamtstrahlungsfluß Φ_e
- SMR® (Surface Mount Radial)-Gehäuse
- Sehr kurze Schaltzeiten (10 ns)
- Sehr hohe Langzeitstabilität
- Hohe Zuverlässigkeit

Anwendungen

- Bauteil mit hoher Strahlstärke zur Oberflächenmontage (SMT)
- Schnelle Datenübertragung mit Übertragungsraten bis 100 Mbaud (IR Tastatur, Joystick, Multimedia)
- Analoge und digitale Hi-Fi Audio- und Videosignalübertragung
- Batteriebetriebene Geräte (geringe Stromaufnahme)
- Anwendungen mit hohen Zuverlässigkeitsansprüchen bzw. erhöhten Anforderungen
- Alarm- und Sicherungssysteme
- IR Freiraumübertragung

Features

- High pulse power and high radiant flux Φ_e
- SMR® (Surface Mount Radial) package
- Very short switching times (10 ns)
- Very high long-time stability
- High reliability

Applications

- Device with high radiant intensity suitable for surface mounting (SMT)
- High data transmission rate up to 100 Mbaud (IR keyboard, Joystick, Multimedia)
- Analog and digital Hi-Fi audio and video signal transmission
- Low power consumption (battery) equipment
- Suitable for professional and high-reliability applications
- Alarm and safety equipment
- IR free air transmission

Typ Type	Bestellnummer Ordering Code	Gehäuse Package
SFH 4500	Q62702-P5163	5-mm-SMR [®] -Gehäuse (T1 ¾), schwarzes Epoxy-Gießharz, Anschlüsse (SFH 4500 gebogen, SFH 4505 gerade) im 2.54-mm-Raster (1/10"), Kathodenkennung: siehe Maßzeichnung. 5 mm SMR [®] package (T1 ¾), black epoxy resin, solder tabs (SFH 4500 bent, SFH 4505 straight) lead spacing 2.54 mm (1/10"), cathode marking: see package outline.
SFH 4505	Q62702-P5164	

Grenzwerte ($T_A = 25\text{ °C}$)**Maximum Ratings**

Bezeichnung Parameter	Symbol Symbol	Wert Value	Einheit Unit
Betriebs- und Lagertemperatur Operating and storage temperature range	$T_{op}; T_{stg}$	- 40 ... + 85	°C
Sperrspannung Reverse voltage	V_R	3	V
Durchlaßstrom Forward current	I_F (DC)	100	mA
Stoßstrom Surge current $t_p = 10\ \mu\text{s}, D = 0$	I_{FSM}	1	A
Verlustleistung Power dissipation	P_{tot}	180	mW
Wärmewiderstand Sperrschicht - Umgebung, freie Beinchenlänge max. 10 mm Thermal resistance junction - ambient, lead length between package bottom and PCB max. 10 mm	R_{thJA}	375	K/W

Kennwerte ($T_A = 25\text{ °C}$)

Characteristics

Bezeichnung Parameter	Symbol Symbol	Wert Value	Einheit Unit
Wellenlänge der Strahlung Wavelength of peak emission $I_F = 100\text{ mA}$, $t_p = 20\text{ ms}$	λ_{peak}	950	nm
Spektrale Bandbreite bei 50% von I_{max} Spectral bandwidth at 50% of I_{max} $I_F = 100\text{ mA}$, $t_p = 20\text{ ms}$	$\Delta\lambda$	40	nm
Abstrahlwinkel Half angle	φ	± 10	Grad deg.
Aktive Chipfläche Active chip area	A	0.09	mm ²
Abmessungen der aktiven Chipfläche Dimension of the active chip area	$L \times B$ $L \times W$	0.3×0.3	mm
Schaltzeiten, I_e von 10% auf 90% und von 90% auf 10% Switching times, I_e from 10% to 90% and from 90% to 10% $I_F = 100\text{ mA}$, $t_p = 20\text{ ms}$, $R_L = 50\ \Omega$	t_r , t_f	10	ns
Kapazität Capacitance $V_R = 0\text{ V}$, $f = 1\text{ MHz}$	C_o	35	pF
Durchlaßspannung Forward voltage $I_F = 100\text{ mA}$, $t_p = 20\text{ ms}$ $I_F = 1\text{ A}$, $t_p = 100\ \mu\text{s}$	V_F V_F	1.5 (≤ 1.8) 3.2 (≤ 3.6)	V V
Sperrstrom Reverse current $V_R = 3\text{ V}$	I_R	0.01 (≤ 10)	μA
Gesamtstrahlungsfluß Total radiant flux $I_F = 100\text{ mA}$, $t_p = 20\text{ ms}$	Φ_e	32	mW
Temperaturkoeffizient von I_e bzw. Φ_e Temperature coefficient of I_e or Φ_e $I_F = 100\text{ mA}$	TC_I	- 0.44	%/K

Kennwerte ($T_A = 25\text{ °C}$) (cont'd)**Characteristics**

Bezeichnung Parameter	Symbol Symbol	Wert Value	Einheit Unit
Temperaturkoeffizient von V_F Temperature coefficient of V_F $I_F = 100\text{ mA}$	TC_V	- 1.5	mV/K
Temperaturkoeffizient von λ Temperature coefficient of λ $I_F = 100\text{ mA}$	TC_λ	+ 0.2	nm/K

Strahlstärke I_e in Achsrichtunggemessen bei einem Raumwinkel von $\Omega = 0.01\text{ sr}$ **Radiant Intensity I_e in Axial Direction**measured at a solid angle of $\Omega = 0.01\text{ sr}$

Bezeichnung Parameter	Symbol Symbol	Wert Value	Einheit Unit
Strahlstärke Radiant intensity $I_F = 100\text{ mA}$, $t_p = 20\text{ ms}$	$I_{e\text{ min}}$ $I_{e\text{ typ}}$	40 80	mW/sr mW/sr
Strahlstärke Radiant intensity $I_F = 1\text{ A}$, $t_p = 100\text{ }\mu\text{s}$	$I_{e\text{ typ}}$	500	mW/sr

Lötbedingungen**Soldering Conditions**

Tauch-, Schwall- und Schlepplötlung Dip, wave and drag soldering			Kolbenlötlung (mit 1,5-mm-Kolbenspitze) Iron soldering (with 1.5-mm-bit)		
Lötbad- temperatur	Maximal zulässige Lötzeit	Abstand Lötstelle – Gehäuse	Temperatur des Kolbens	Maximale zulässige Lötzeit	Abstand Lötstelle – Gehäuse
Temperature of the soldering bath	Max. perm. soldering time	Distance between solder joint and case	Temperature of the solder- ing iron	Max. permis- sible solder- ing time	Distance between solder joint and case
260 °C	10 s	$\geq 1.5\text{ mm}$	300 °C	3 s	$\geq 1.5\text{ mm}$

Relative Spectral Emission

$I_{\text{erel}} = f(\lambda)$

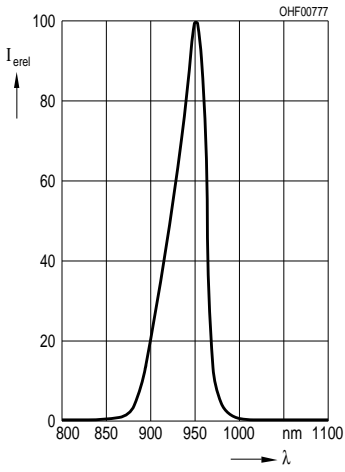

Radiant Intensity $I_e/I_{e(100\text{ mA})} = f(I_F)$
Single pulse, $t_p = 20\ \mu\text{s}$

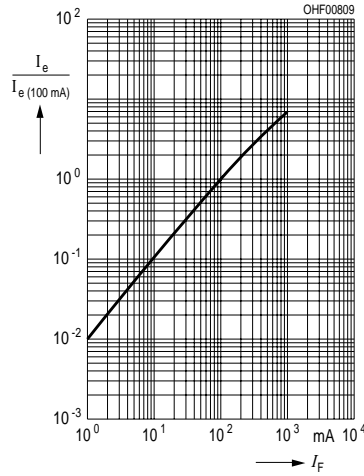

Max. Permissible Forward Current

$I_F = f(T_A)$

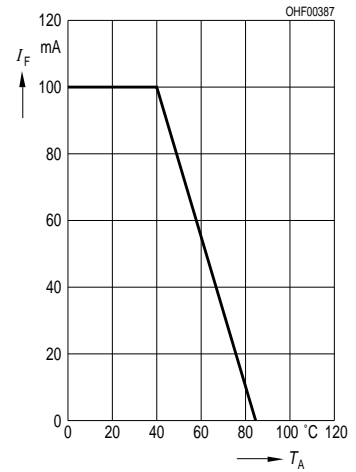

Forward Current $I_F = f(V_F)$
single pulse, $t_p = 20\ \mu\text{s}$

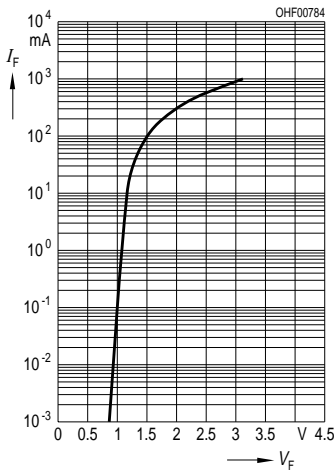

Radiation Characteristic

$I_{\text{erel}} = f(\varphi)$

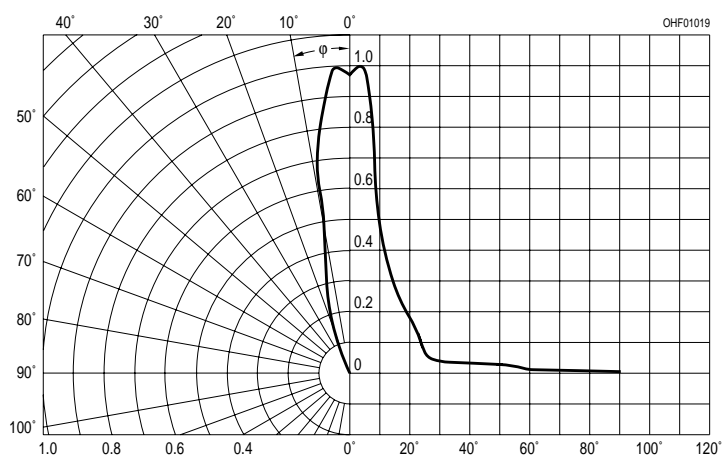

Maßzeichnungen
Package Outlines

SFH 4500

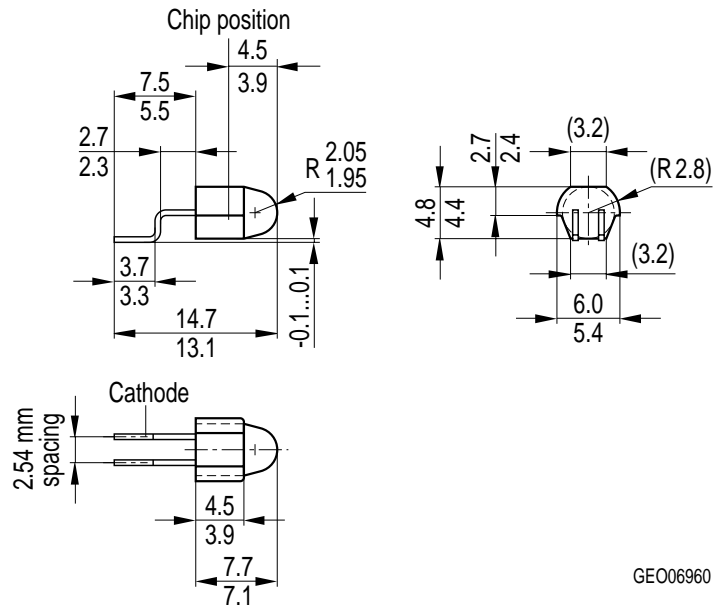

SFH 4505

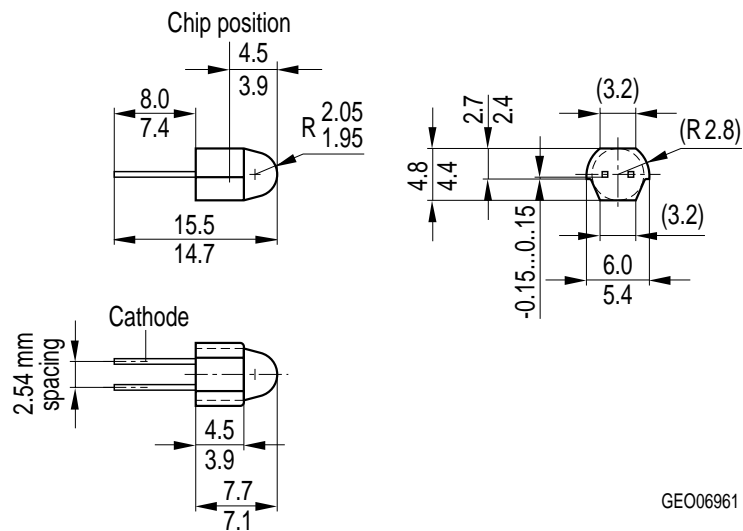

Maße in mm, wenn nicht anders angegeben / Dimensions in mm, unless otherwise specified.