



FEATURES

- 125 WATTS MAXIMUM OUTPUT POWER
- SINGLE OUTPUT UP TO 35A
- COMPACT 2.28 X 1.45 X 0.50 INCH PACKAGE
- HIGH EFFICIENCY UP TO 90%
- 2:1 WIDE INPUT VOLTAGE RANGE
- FIXED SWITCHING FREQUENCY
- INDUSTRY STANDARD FOOTPRINT
- NO MINIMUM LOAD
- ADJUSTABLE OUTPUT VOLTAGE
- UNDER-VOLTAGE LOCKOUT
- INPUT TO OUTPUT ISOLATION (BASIC INSULATION)
- CE MARK MEETS 2006/95/EC, 93/68/EEC AND 2004/108/EC
- UL60950-1, EN60950-1 AND IEC60950-1 LICENSED
- ISO9001 CERTIFIED MANUFACTURING FACILITIES
- COMPLIANT TO RoHS EU DIRECTIVE 2002/95/EC

APPLICATIONS

Wireless Network
Telecom/Datacom
Industry Control System
Distributed Power Architectures
Semiconductor Equipment

OPTIONS

Positive logic Remote on/off, Pin length

DESCRIPTION

QEB125 single output DC/DC converters provide up to 125 watts of output power in an industry standard quarter-brick package and footprint. These units are specifically designed to meet the power needs of low-voltage silicon. All models feature a wide input range, trimmable output voltage and a 35A current rating.

TECHNICAL SPECIFICATION All specifications are typical at nominal input, full load and 25°C otherwise noted

OUTPUT SPECIFICATIONS		
Output power		125 Watts, max.
Voltage accuracy	Full load and Normal Vin	± 1.5%
Minimum load		0%
Voltage adjustability	(Note 5)	+ 10% , -20%
Line regulation	LL to HL at Full Load	±0.2%
Load regulation	No load to Full Load	See table
Remote Sense	(Note 5)	10% of Vout
Ripple and noise	20MHz bandwidth (Measured with a 1µF M/C and a 10µFT/C)	See table
Temperature coefficient		±0.02% / °C, max.
Transient response recovery time	25% load step change	200µS
Over voltage protection threshold (Non-latching Hiccup)		120% Vout max.
Over Current Protection threshold		110% ~ 140% of Iout Rated
Short circuit protection		Hiccup, automatics recovery
GENERAL SPECIFICATIONS		
Efficiency		See table
Isolation voltage	Input to Output Input to Case Output to Case	1600VDC, min. 1000VDC, min. 1000VDC, min.
Isolation resistance		10 ⁷ ohms, min.
Isolation capacitance		2500 pF, max.
Switching frequency		270 KHz, typ.
Approvals and standard		IEC60950-1, UL60950-1, EN60950-1
Case material		Aluminum base plate
Weight (approx)		42g (1.46 oz)
MTBF (Note 1)	BELLCORE TR-NWT-000332 MIL-HDBK-217F	2.500 x 10 ⁶ hrs 1.257 x 10 ⁵ hrs

INPUT SPECIFICATIONS			
Input voltage range	24V nominal input 48V nominal input		18 – 36VDC 36 – 75VDC
Input filter			L-C type
Input surge voltage 100mS max	24V nominal input 48V nominal input		50VDC 100VDC
Start up time	Nominal Vin and constant resistive load	Power up Remote ON/OFF	25mS, typ. 25mS, typ.
Start-up voltage	24V nominal input 48V nominal input		17VDC 34VDC
Shutdown voltage	24V nominal input 48V nominal input		15VDC 32VDC
Remote ON/OFF (Note 6)			
Negative logic(Standard)	DC-DC ON DC-DC OFF		Short or 0V < Vr < 1.2V Open or 3V < Vr < 15V
Positive logic(OPTION)	DC-DC ON DC-DC OFF		Open or 3V < Vr < 15V Short or 0V < Vr < 1.2V
Input current of remote control pin	Nominal Vin		-0.5~1.0mA
Remote off state input current	Nominal Vin		2.5mA

ENVIRONMENTAL SPECIFICATIONS	
Operating base-plate temperature range (Note 7)	-40°C to +100°C (with derating)
Over temperature protection	110°C, max.
Storage temperature range	-55°C to +125°C
Thermal shock	MIL-STD-810F
Vibration	10~55Hz, 2G, 30minutes along X,Y and Z
Humidity , Max , Non-Condensing	95%

EMC CHARACTERISTICS		
EMI (Note 8)	EN55022	Class A
Radiated immunity	EN61000-4-3	10 V/m Perf. Criteria A
Fast transient (Note 9)	EN61000-4-4	± 2KV Perf. Criteria B
Surge (Note 9)	EN61000-4-5	± 1KV Perf. Criteria B
Conducted immunity	EN61000-4-6	10 Vr.m.s Perf. Criteria A



Model Number	Input Range	Output Voltage	Output Current		Output ⁽⁴⁾ Ripple & Noise	Input Current		Eff ⁽⁴⁾ (%)	Load regulation
			Min. load	Full load		No load ⁽³⁾	Full load ⁽²⁾		
QEB125-24S3P3	18 – 36 VDC	3.3 VDC	0mA	30A	100mVp-p	130mA	4970mA	87	10mV
QEB125-24S05	18 – 36 VDC	5 VDC	0mA	25A	100mVp-p	180mA	6127mA	89	15mV
QEB125-24S12	18 – 36 VDC	12 VDC	0mA	10.42A	100mVp-p	190mA	6129mA	89	36mV
QEB125-24S15	18 – 36 VDC	15 VDC	0mA	8.33A	100mVp-p	190mA	6125mA	89	45mV
QEB125-48S1P8	36 – 75 VDC	1.8 VDC	0mA	35A	100mVp-p	60mA	1641mA	84	5.4mV
QEB125-48S2P5	36 – 75 VDC	2.5 VDC	0mA	35A	100mVp-p	60mA	2223mA	86	7.5mV
QEB125-48S3P3	36 – 75 VDC	3.3 VDC	0mA	30A	100mVp-p	90mA	2455mA	88	10mV
QEB125-48S05	36 – 75 VDC	5 VDC	0mA	25A	100mVp-p	90mA	3028mA	90	15mV
QEB125-48S12	36 – 75 VDC	12 VDC	0mA	10.42A	100mVp-p	130mA	3029mA	90	36mV
QEB125-48S15	36 – 75 VDC	15 VDC	0mA	8.33A	100mVp-p	130mA	3027mA	90	45mV

Note :

- 1.BELLCORE TR-NWT-000332. Case 1: 80% Stress, Temperature at 40°C.
MIL-HDBK-217F Notice2 @Ta=25 °C, Full load(Ground, Benign, controlled environment)
- 2.Maximum value at nominal input voltage and full load of standard type.
- 3.Typical value at nominal input voltage and no load.
- 4.Typical value at nominal input voltage and full load.
- 5.Maximum output deviation is 10% inclusive of trim. If remote sense is not being used, the + sense should be connected to its corresponding +OUTPUT and likewise the –sense should be connected to its corresponding –OUTPUT.
- 6.The positive logic and pin length are optional (see table). The pin voltage is referenced to –Vin.
- 7.Heat sink is optional and P/N : 7G-0029A-F, 7G-0030A-F, 7G-0031A-F, 7G-0032A-F.
- 8.The QEB125 meets EN55022 class A and class B only with external components connected before the input pin to the converter.
- 9.An external input filter capacitor is required if the module has to meet EN61000-4-4, EN61000-4-5.
The filter capacitor Power Mate suggest: Nippon chemi-con KY series, 220 μ F/100V, ESR 48m Ω .
- 10.BASEPLATE GROUNDING : Base-plate should be grounded at one of the four screw bolts prior to operation.
- 11.The converter is provided by basic insulation.



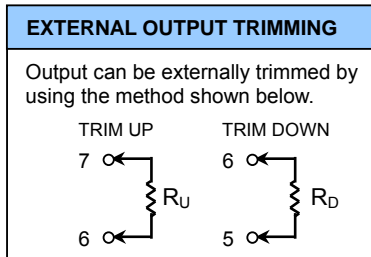
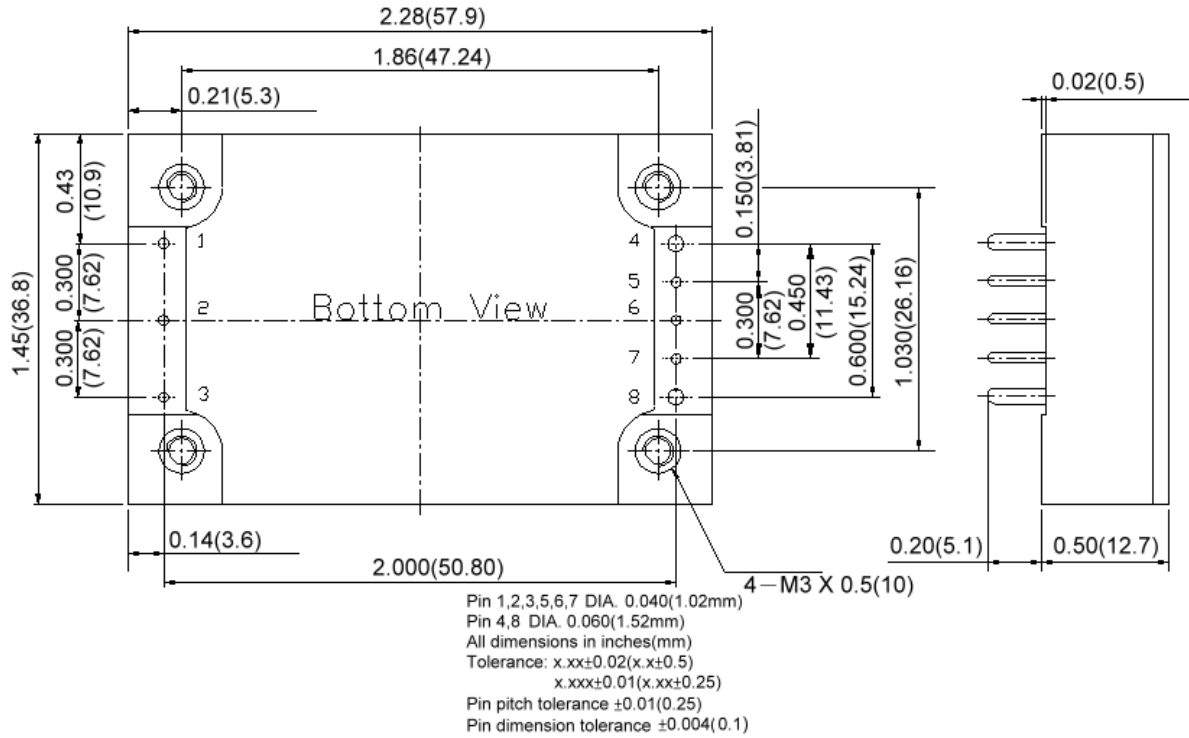

PIN CONNECTION	
PIN	Define
1	- INPUT
2	ON/OFF
3	+ INPUT
4	- OUTPUT
5	- SENSE
6	TRIM
7	+ SENSE
8	+ OUTPUT

PRODUCT OPTIONS TABLE	
Option	Suffix
Negative remote ON/OFF logic, 0.20" pin length (standard)	-
Negative remote ON/OFF logic, 0.145" pin length	-L
Negative remote ON/OFF logic, 0.11" pin length	-K
Positive remote ON/OFF logic, 0.20" pin length	-P
Positive remote ON/OFF logic, 0.145" pin length	-S
Positive remote ON/OFF logic, 0.11" pin length	-M

Example : QEB125-48S3P-P



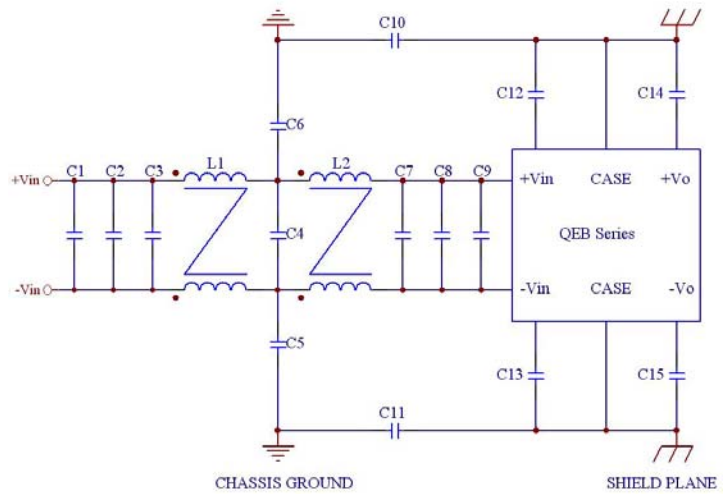
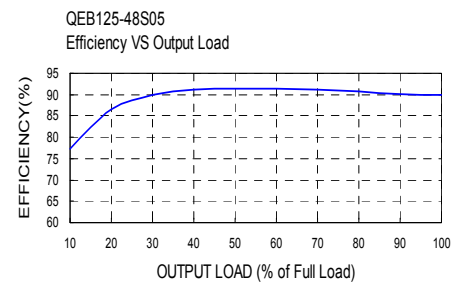
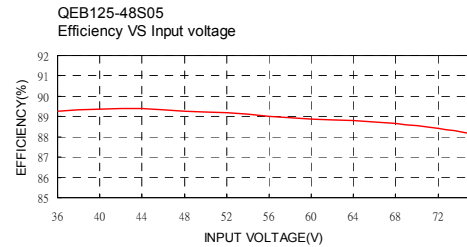
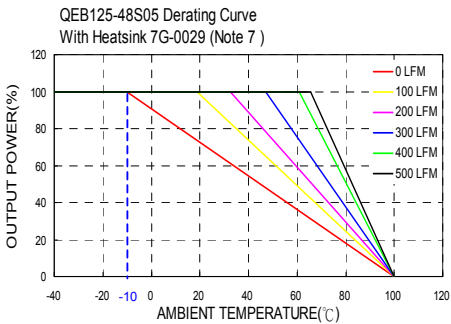
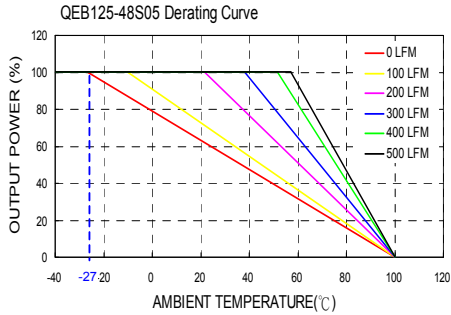

Recommended Filter for EN55022 Class B Compliance

The components used in the above figure, together with the manufacturers' part numbers for these components, are as follows:

	C1	C2	C3	C4	C5
QEB125-24Sxx	6.8μF/50V	6.8μF/50V	6.8μF/50V	6.8μF/50V	1.5nF/3KV
	C6	C7	C8	C9	C10
	1.5nF/3KV	6.8μF/50V	6.8μF/50V	6.8μF/50V	0.1μF/50V
	C11	C12	C13	C14	C15
	0.1μF/50V	1.0nF/3KV	1.0nF/3KV	1.0nF/3KV	1.0nF/3KV
	L1	L2			
	622μH	224μH			

	C1	C2	C3	C4	C5
QEB125-48Sxx	100μF/100V	1.5μF/100V	1.5μF/100V	1.5μF/100V	1.5nF/3KV
	C6	C7	C8	C9	C10
	1.5nF/3KV	47μF/100V	1.5μF/100V	1.5μF/100V	0.1μF/50V
	C11	C12	C13	C14	C15
	0.1μF/50V	1.0nF/3KV	1.0nF/3KV	1.0nF/3KV	1.0nF/3KV
	L1	L2			
	620μH	620μH			

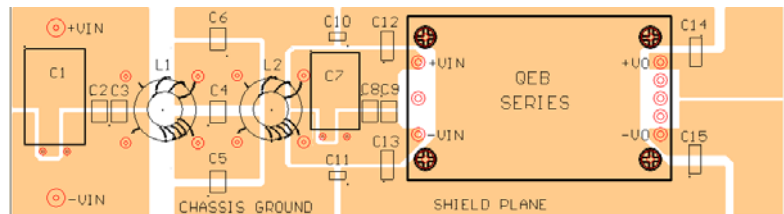

Recommended EN55022 Class B Filter Circuit Layout

