

Product Overview

The QPD0020 is a 35 W unmatched discrete GaN on SiC HEMT which operates from DC to 6 GHz on a +48 V supply rail. It is ideally suited for base station, radar and communications applications and can support both CW and pulsed mode of operations.

The QPD0020 can be used in Doherty architecture for the final stage of a base station power amplifier for small cell, microcell, and active antenna systems. The QPD0020 can also be used as a driver in a macrocell base station power amplifier.

The device is housed in an industry-standard 4x3 mm surface mount QFN package.

Lead-free and ROHS compliant.

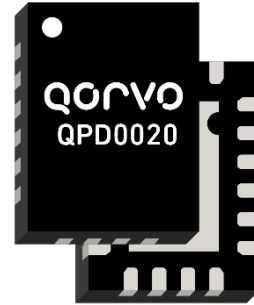

20 Pin 4x3 mm QFN Package

Key Features

- Operating Frequency Range: DC to 6 GHz
- Operating Drain Voltage: +48 V
- Maximum Output Power (P_{SAT}): 34.7 W ⁽¹⁾
- Maximum Drain Efficiency: 77.8% ⁽¹⁾
- Efficiency-Tuned P3dB Gain: 18.8 dB ⁽¹⁾
- Surface Mount Plastic Package

Notes:

1. Based on 2.7 GHz load pull data.

Functional Block Diagram

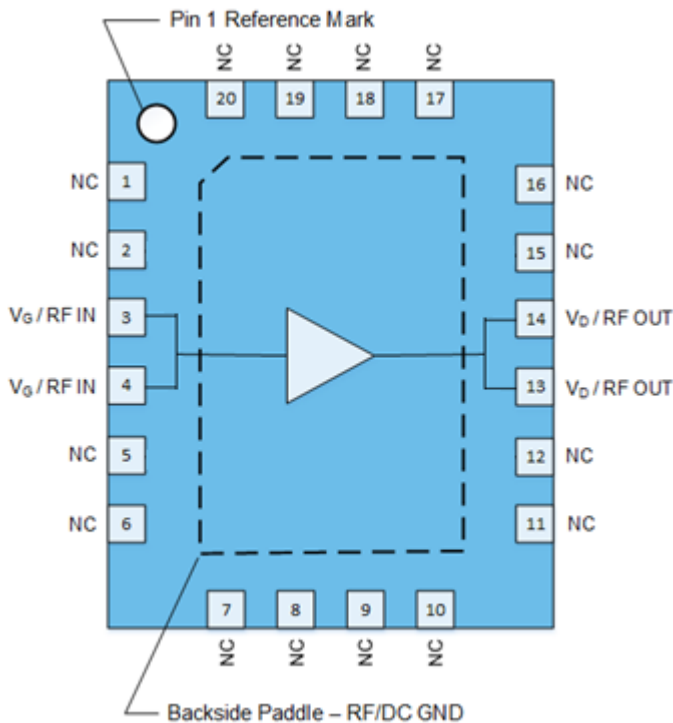

Applications

- W-CDMA / LTE
- Macrocell Base Station Driver
- Microcell Base Station
- Small Cell Final Stage
- Active Antenna
- Land Mobile and Military Radio Communications
- General Purpose Applications

Ordering Information

Part Number	Description
QPD0020S2	Sample – 2 Pieces
QPD0020TR7	7" Reel – 500 Pieces
QPD0020EVB02	2.62 – 2.69 GHz Evaluation Board

Absolute Maximum Ratings

Parameter	Rating
Breakdown Voltage (BV_{DG})	+165 V
Gate Voltage Range ($V_{G1,2}$)	-7 to +2 V
Drain Voltage ($V_{D1,2}$)	+55 V
Peak RF Input Power	29 dBm
VSWR Mismatch, P1dB Pulse (20% Duty Cycle, 100 μ s Width), $T = +25^{\circ}\text{C}$	10:1
Storage Temperature	-65 to 150°C

Exceeding any one or a combination of the Absolute Maximum Rating conditions may cause permanent damage to the device. Extended application of Absolute Maximum Rating conditions to device may reduce device reliability.

Recommended Operating Conditions

Parameter	Min	Typ	Max	Units
Gate Voltage (V_G)		-2.7		V
Drain Voltage (V_D)		+48		V
Quiescent Current (I_{DQ})		30		mA

Electrical specifications are measured at specified test conditions. Specifications are not guaranteed over all recommended operating conditions.

Electrical Specifications

Parameter	Conditions	Min	Typ	Max	Units
Operational Frequency Range		2620		2690	MHz
Quiescent Current			30		mA
Gain	3 dB Compression		16.7		dB
Power (P_{SAT})	3 dB Compression		44.1		dBm
Drain Efficiency	3 dB Compression		68.2		%

Test conditions unless otherwise noted: $V_D = +48\text{ V}$, $I_{DQ} = 30\text{ mA}$, $T = +25^{\circ}\text{C}$, pulsed CW signal (10% duty cycle, 1 ms width) on a single-ended reference design fixture tuned for 2620 – 2690 MHz.

Thermal Information

Parameter	Conditions	Values	Units
Thermal Resistance, Peak IR Surface Temperature at Average Power (θ_{JC})	$T_{CASE} = +105^{\circ}\text{C}$, $T_{CH} = 144^{\circ}\text{C}$ CW: $P_{DISS} = 7.4\text{ W}$, $P_{OUT} = 1.6\text{ W}$	5.3	$^{\circ}\text{C/W}$
Thermal Resistance, Peak IR Surface Temperature at Average Power (θ_{JC})	$T_{CASE} = +105^{\circ}\text{C}$, $T_{CH} = 169^{\circ}\text{C}$ CW: $P_{DISS} = 10.9\text{ W}$, $P_{OUT} = 5.6\text{ W}$	5.9	$^{\circ}\text{C/W}$

Notes:

1. Thermal resistance is measured to package backside.
2. Refer to the following document: [GaN Device Channel Temperature, Thermal Resistance, and Reliability Estimates](#)

QPD0020EVB02 Layout – 2.62 – 2.69 GHz Reference Design

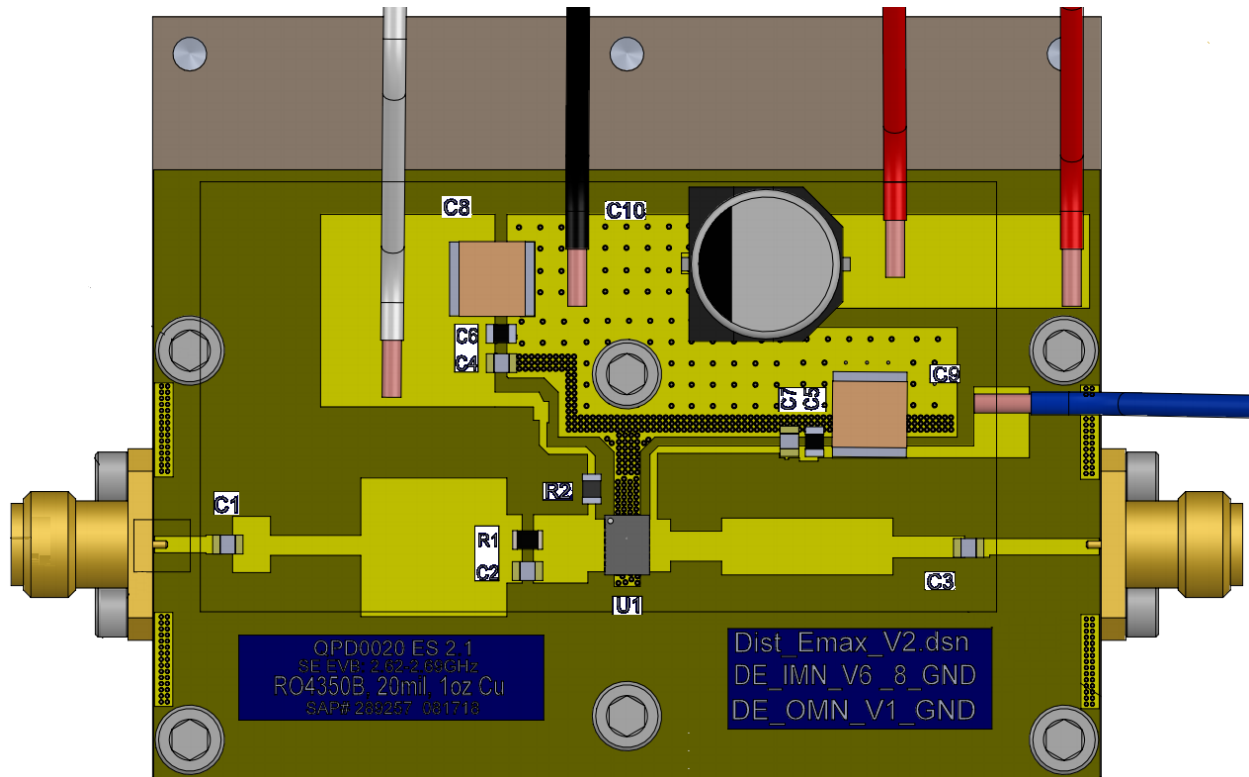

QPD0020EVB02 Bill of Materials

Reference Des.	Value	Description	Manuf.	Part Number
C1, C2	3 pF	Capacitor, 3 pF, ±0.1pF, 250 V, C0G, 0805	ATC	600F3R0BT250XT
C3	2 pF	Capacitor, 2 pF, ±0.1 pF, 250 V, C0G, 0805	ATC	600F2R0BT250XT
C4, C7	10 pF	Capacitor, 10 pF, ±1%, 250 V, C0G, 0805	ATC	600F100FT250XT
C5, C6	4.7 µF	Capacitor, 4.7 µF, ±20%, 50 V, X5R, 0805	Murata	GRT21BR61H475ME13L
C8, C9	10 µF	Capacitor, 10 µF, ±20%, 50 V, STD, 2220	TDK	C5750X7R1H106K230KB
C10	220 µF	Capacitor, 220 µF, ±20%, 50 V, Electrolytic	United Chemi-Con	EMVY500ADA221MJA0G
R1	47 Ω	Resistor, 47 Ω, ±5%, 1/10 W, 0805	Panasonic	ERJ-6GEYJ470
R2	20 Ω	Resistor, 20 Ω, ±5%, 1/10 W, 0805	Panasonic	ERJ-6GEYJ200
U1	–	35 W, 48 V, DC – 6 GHz, GaN RF Transistor	Qorvo	QPD0020

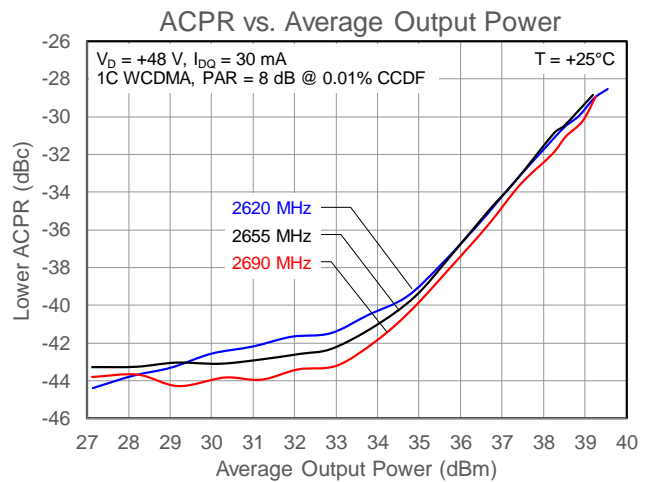
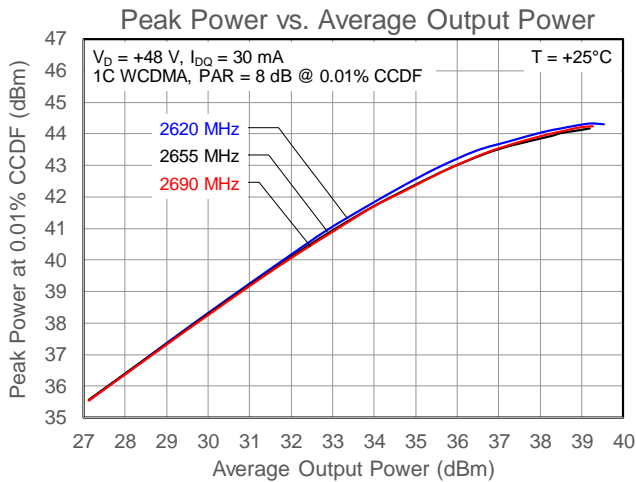
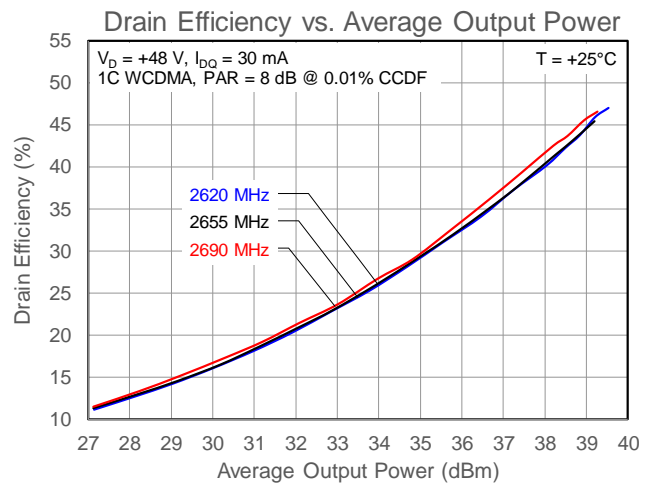
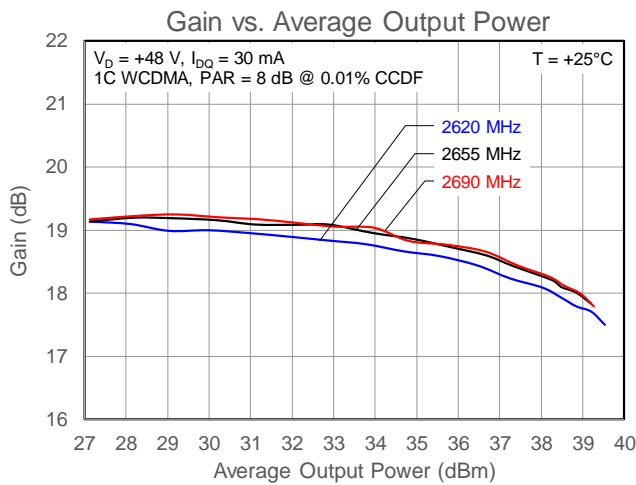
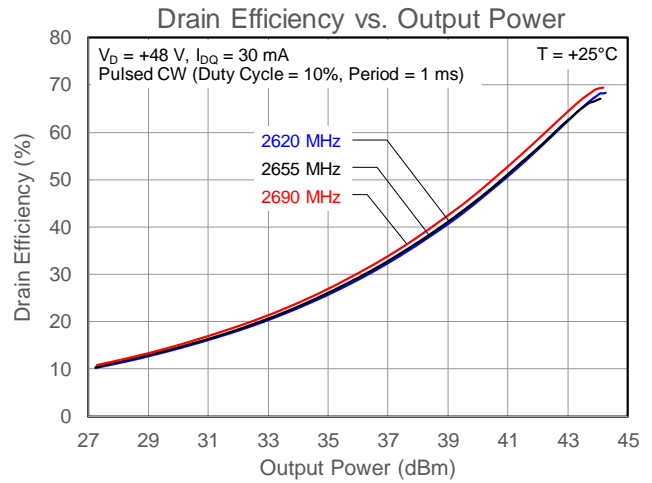
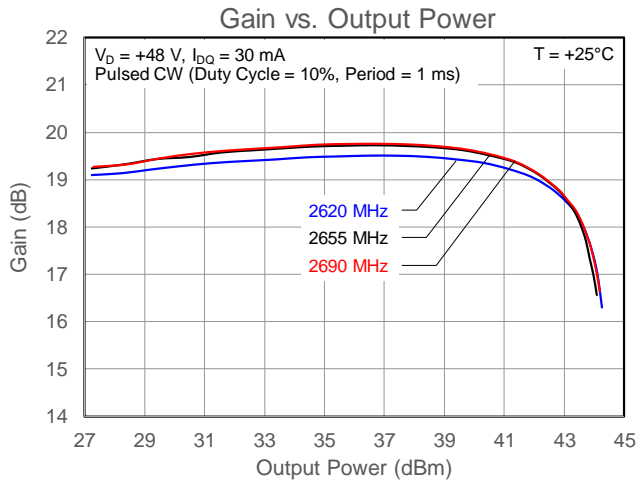
QPD0020EVB02 Performance Plots

Test conditions unless otherwise noted: $V_D = +48\text{ V}$, $I_{DQ} = 30\text{ mA}$, $T = +25^\circ\text{C}$, pulsed CW signal (10% duty cycle, 1 ms period) on a 2620 – 2690 MHz reference design fixture.

QPD0020EVB02 Performance Plots

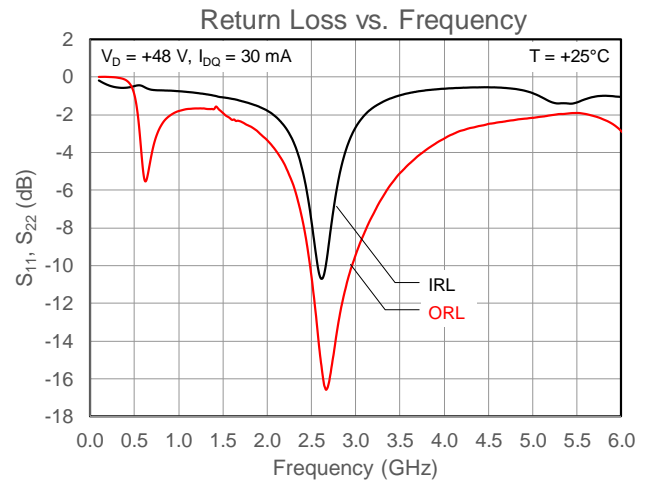
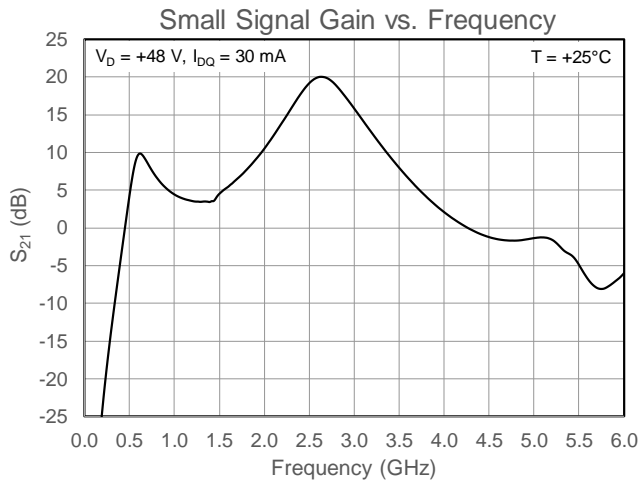

Test conditions unless otherwise noted: $V_D = +48\text{ V}$, $I_{DQ} = 30\text{ mA}$, $T = +25^\circ\text{C}$, pulsed CW signal (10% duty cycle, 1 ms period) on a 2620 – 2690 MHz reference design fixture.

Power-Matched Load Pull Performance

Frequency (MHz)	Source Impedance (Ω)	Load Impedance (Ω)	P3dB (dBm)	Drain Efficiency (%)	G3dB (dB)
2500	2.87 + j1.08	14.06 + j5.73	45.3	62.5	18.5
2600	2.86 + j1.07	13.72 + j7.59	45.3	67.6	18.5
2700	4.10 + j0.01	14.16 + j7.51	45.4	68.2	17.5

Test conditions unless otherwise noted: $V_D = +48\text{ V}$, $I_{DQ} = 30\text{ mA}$, $T = +25^\circ\text{C}$, pulsed CW (20% duty cycle, 100 μs width).

Efficiency-Matched Load Pull Performance

Frequency (MHz)	Source Impedance (Ω)	Load Impedance (Ω)	P3dB (dBm)	Drain Efficiency (%)	G3dB (dB)
2500	2.87 + j1.08	9.32 + j17.22	43.4	78.3	20.4
2600	2.86 + j1.07	10.41 + j15.61	43.8	76.8	19.6
2700	4.10 + j0.01	8.59 + j16.46	43.1	77.8	18.8

Test conditions unless otherwise noted: $V_D = +48\text{ V}$, $I_{DQ} = 30\text{ mA}$, $T = +25^\circ\text{C}$, pulsed CW (20% duty cycle, 100 μs width).

Load Pull Contours

Test Conditions unless otherwise noted: $V_D = +48\text{ V}$, $I_{DQ} = 30\text{ mA}$, $T = +25^\circ\text{C}$, pulsed CW (20% duty cycle, 100 μs width).

Load Pull at 2500 MHz

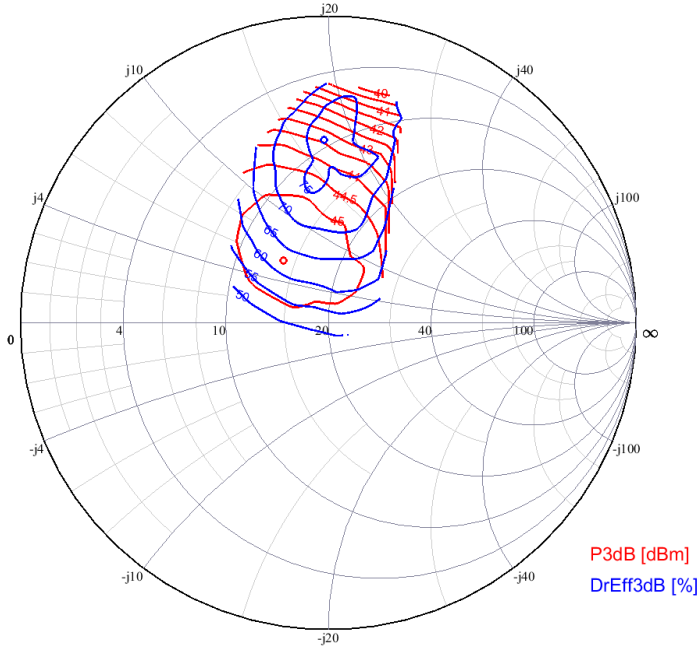

Load Pull at 2600 MHz

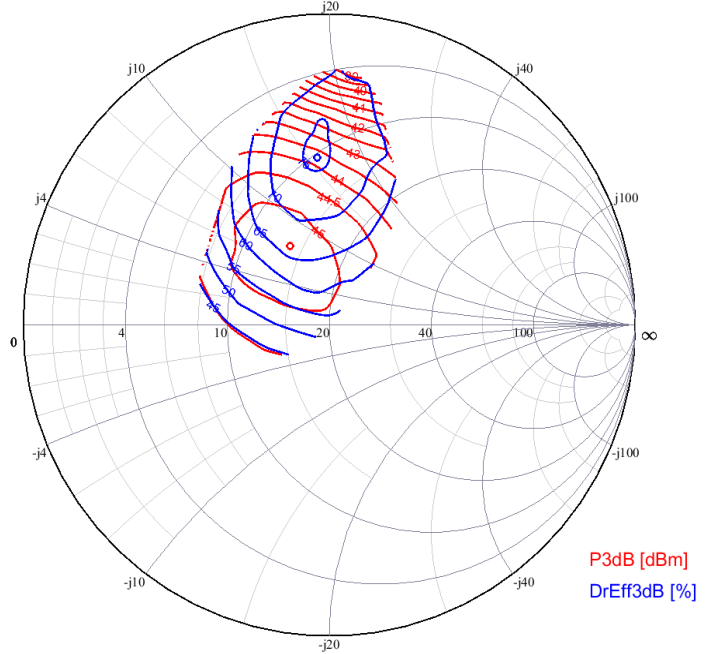

Load Pull at 2700 MHz

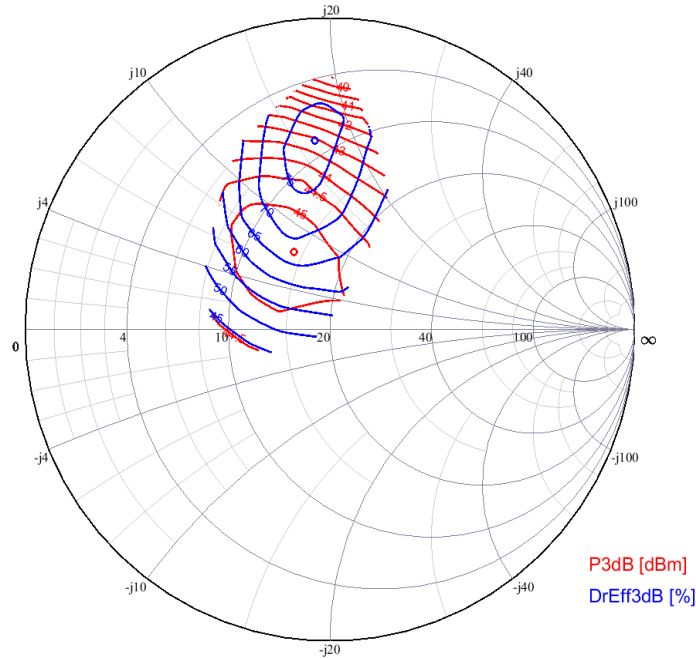

Package Marking and Pin Configuration

Marking: Qorvo Logo
Part Number – 0020
Date Code – YYWW
Production Lot Number - MXXX

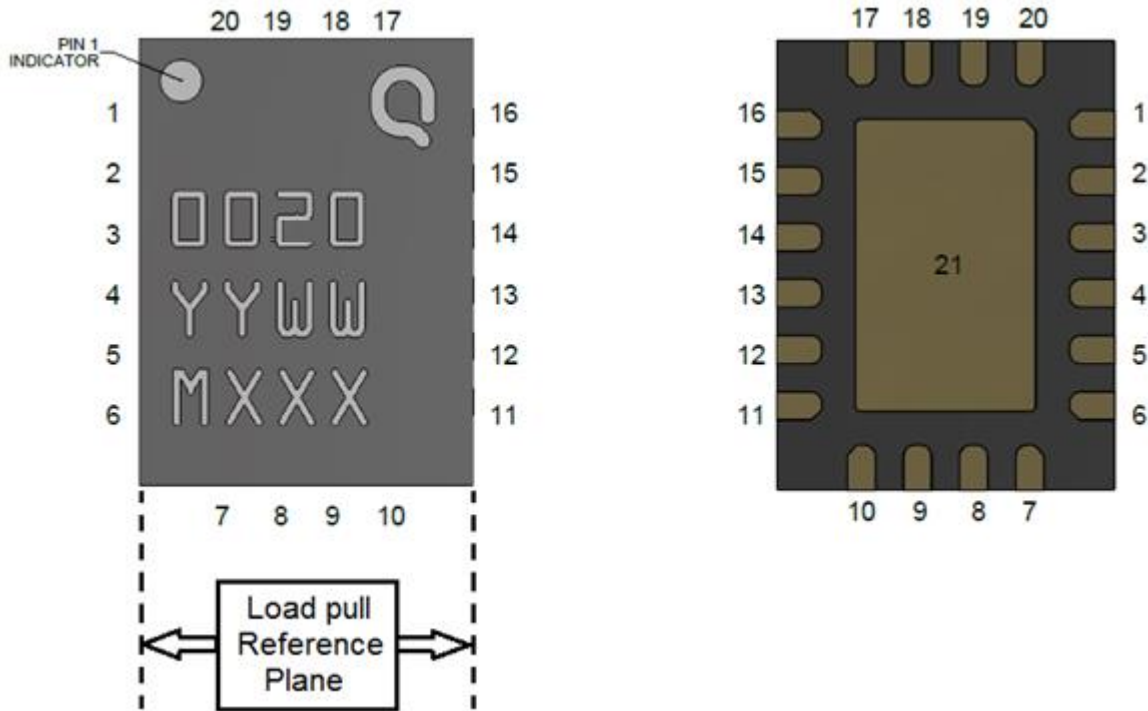

Pin Number	Label	Description
1, 2	NC	Not Connected
3, 4	RF IN / VG	RF Input / Gate Voltage
5, 6, 7, 8, 9, 10, 11, 12	NC	Not Connected
13, 14	RF OUT / VD	RF Output / Drain Voltage
15, 16, 17, 18, 19, 20	NC	Not Connected
21	GND	Source to be connected to ground

Package Dimensions

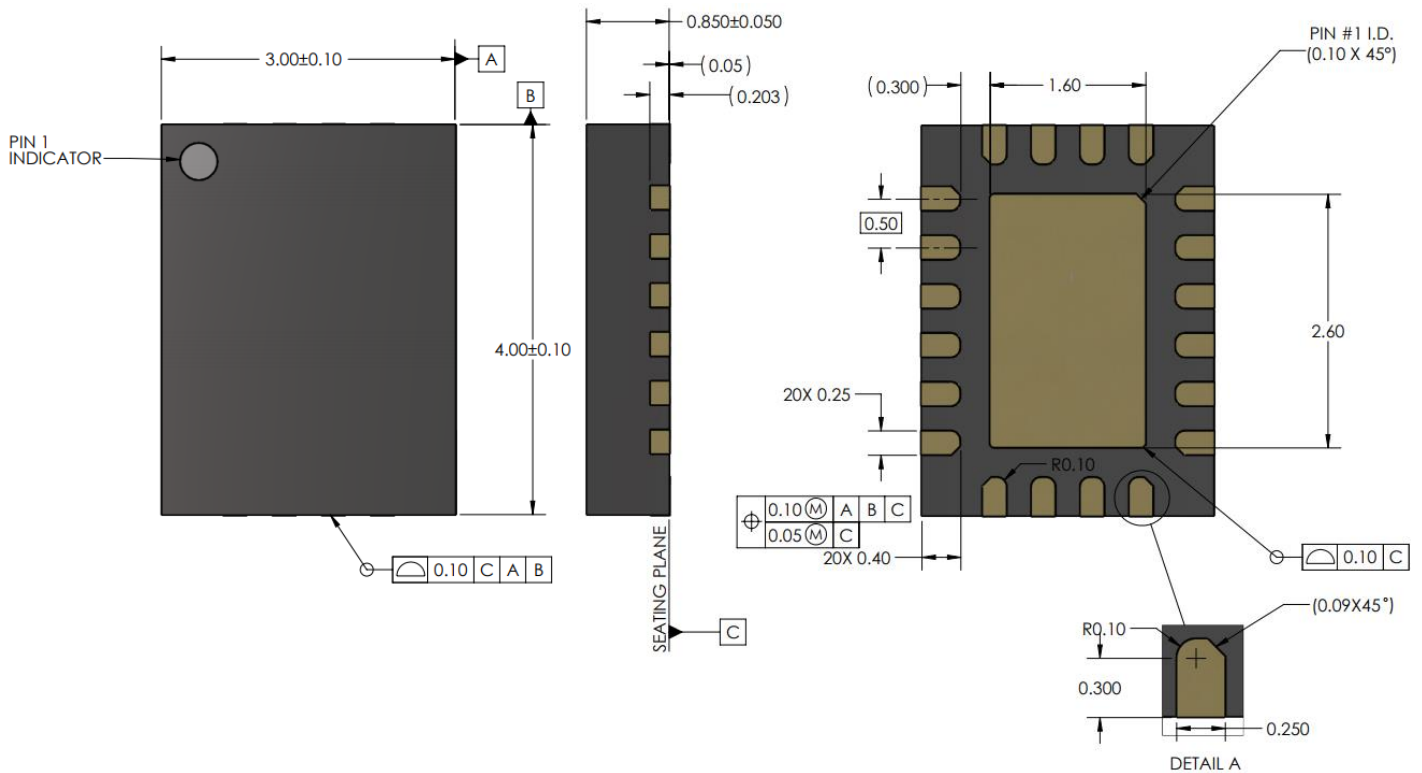

Notes:

1. All dimensions are in millimeters. Angles are in degrees.
2. General tolerance is ± 0.25 .
3. Part is overmold encapsulated.
4. Contact plating is NiPdAu. Au thickness is 0.00254 to 0.01501 μm .

Bias Procedure

Bias-Up Procedure	Bias-Down Procedure
1. Set V_G to -4 V.	1. Turn off RF signal.
2. Apply +48 V V_D .	2. Turn off V_D .
3. Slowly adjust V_G until I_D is set to 30 mA.	3. Wait two (2) seconds to allow drain capacitor to discharge.
4. Apply RF.	4. Turn off V_G .

Recommended Solder Temperature Profile

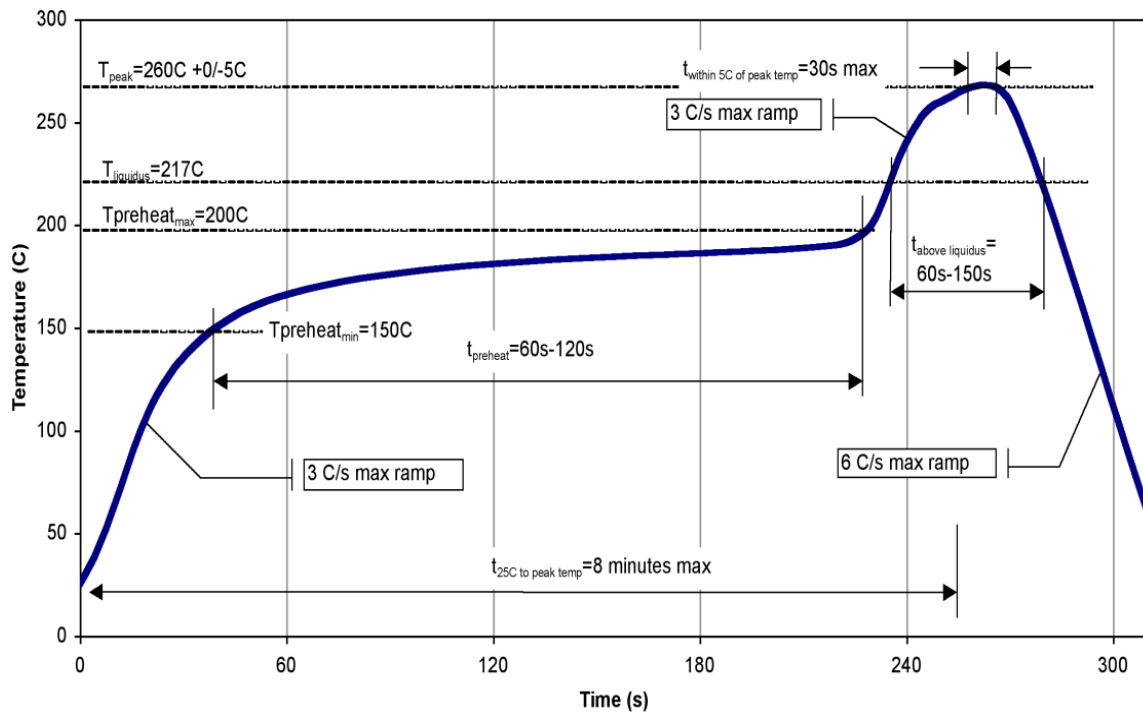

Handling Precautions

Parameter	Rating	Standard
ESD – Human Body Model (HBM)	TBD	ANSI/ESDA/JEDEC Standard JS-001
ESD – Charged Device Model (CDM)	TBD	ANSI/ESDA/JEDEC Standard JS-002
MSL – Moisture Sensitivity Level	TBD	IPC/JEDEC Standard J-STD-020



Solderability

Compatible with lead-free (260°C max. reflow temp.) soldering processes.

Package lead plating is NiPdAu. Au thickness is 0.00254 to 0.01501 µm.

RoHS Compliance

This part is compliant with 2011/65/EU RoHS directive (Restrictions on the Use of Certain Hazardous Substances in Electrical and Electronic Equipment) as amended by Directive 2015/863/EU.

This product also has the following attributes:

- Lead Free
- Halogen Free (Chlorine, Bromine)
- Antimony Free
- TBBP-A (C₁₅H₁₂Br₄O₂) Free
- PFOS Free
- SVHC Free



Contact Information

For the latest specifications, additional product information, worldwide sales and distribution locations:

Web: www.qorvo.com

Tel: 1-844-890-8163

Email: customer.support@qorvo.com

For technical questions and application information:

Email: BTSApplications@qorvo.com

Important Notice

The information contained herein is believed to be reliable; however, Qorvo makes no warranties regarding the information contained herein and assumes no responsibility or liability whatsoever for the use of the information contained herein. All information contained herein is subject to change without notice. Customers should obtain and verify the latest relevant information before placing orders for Qorvo products. The information contained herein or any use of such information does not grant, explicitly or implicitly, to any party any patent rights, licenses, or any other intellectual property rights, whether with regard to such information itself or anything described by such information. **THIS INFORMATION DOES NOT CONSTITUTE A WARRANTY WITH RESPECT TO THE PRODUCTS DESCRIBED HEREIN, AND QORVO HEREBY DISCLAIMS ANY AND ALL WARRANTIES WITH RESPECT TO SUCH PRODUCTS WHETHER EXPRESS OR IMPLIED BY LAW, COURSE OF DEALING, COURSE OF PERFORMANCE, USAGE OF TRADE OR OTHERWISE, INCLUDING THE IMPLIED WARRANTIES OF MERCHANTABILITY AND FITNESS FOR A PARTICULAR PURPOSE.**

Without limiting the generality of the foregoing, Qorvo products are not warranted or authorized for use as critical components in medical, life-saving, or life-sustaining applications, or other applications where a failure would reasonably be expected to cause severe personal injury or death.

Copyright 2018 © Qorvo, Inc. | Qorvo is a registered trademark of Qorvo, Inc.