

## Fast Recovery Diode Module 100 Amperes/3300 Volts

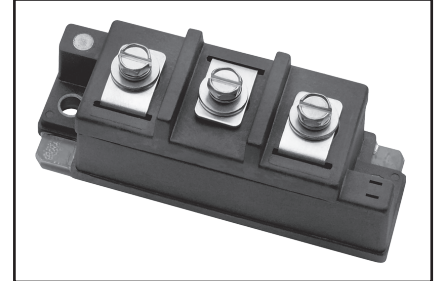
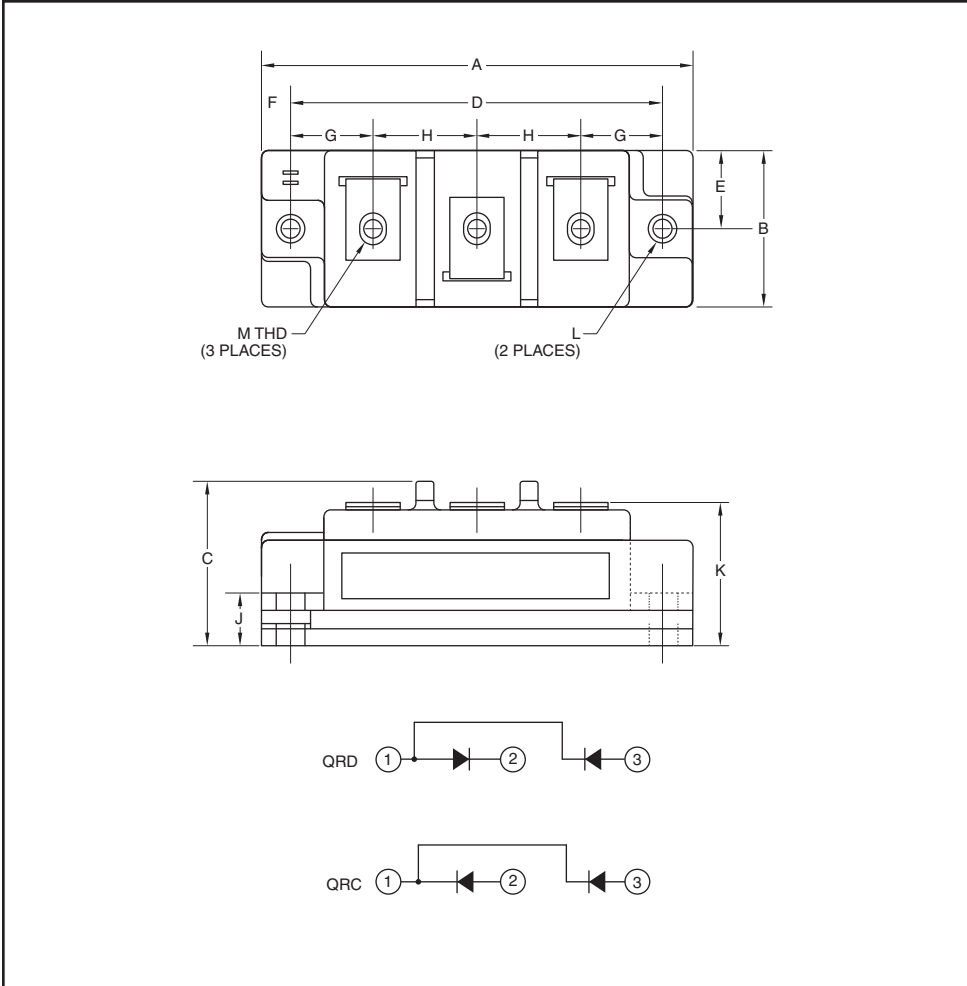

### Description:

Powerex Fast Recovery Diode Modules are designed for use in applications requiring fast switching. The modules are isolated for easy mounting with other components on a common heatsink.

### Features:

- Fast Recovery Time (1.2  $\mu$ s max.)
- Isolation Material - DBC AlN
- Copper Baseplate
- Low Thermal Impedance
- 6000V Isolated Mounting

### Applications:

- Switching Power Supplies
- Inverters
- Choppers
- Welding Power Supplies
- Free Wheeling Diode
- High Frequency Rectifiers

### Outline Drawing and Circuit Diagram

Dimensions	Inches	Millimeters
A	3.70	94.0
B	1.34	34.0
C	1.40	35.6
D	3.15	80.0
E	0.67	17.0
F	0.28	6.99

Dimensions	Inches	Millimeters
G	0.67	17.1
H	0.91	23.0
J	0.36	9.0
K	1.18	30.0
L	0.216 Dia.	5.5 Dia.
M	#10-32	#10-32

**QR\_3310001**

**Fast Recovery Diode Module**

100 Amperes/3300 Volts

**Absolute Maximum Ratings,  $T_j = 25^\circ\text{C}$  unless otherwise specified**

Ratings	Symbol	QRD3310001	Units
		QRC3310001	
Repetitive Peak Reverse Blocking Voltage	$V_{RRM}$	3300	Volts
Non-Repetitive Peak Reverse Blocking Voltage	$V_{RSM}$	$V_{RRM} + 100$	Volts
Average Forward Current	$T_C = 80^\circ\text{C}$	$I_{F(av)}$	86 Amperes
	$T_C = 63^\circ\text{C}$	$I_{F(av)}$	100 Amperes
	$T_C = 25^\circ\text{C}$	$I_{F(av)}$	127 Amperes
Forward Current (Pulse)	$I_{FM}$	200	Amperes
Operating Junction Temperature	$T_j$	-40 to 150	$^\circ\text{C}$
Storage Temperature	$T_{stg}$	-40 to 150	$^\circ\text{C}$
Maximum Mounting Torque, #10-32 Mounting Screw	—	26	in-lb
Maximum Terminal Torque, #10-32 Terminal Screw	—	26	in-lb
Module Weight (Typical)	—	250	Grams
V Isolation (60 Hz, Circuit to Base, All Terminals Shorted, $t = 1$ sec.)	$V_{RMS}$	6000	Volts

**IGBT Electrical Characteristics,  $T_j = 25^\circ\text{C}$  unless otherwise specified**

Characteristics	Symbol	Test Conditions	Min.	Typ.	Max.	Units
Peak Reverse Leakage Current	$I_{RRM}$	Rated $V_{RRM}$	—	—	5	mA
Peak On-State Voltage	$V_{FM}$	$I_F = 100\text{A}$	—	3.3	4.3	Volts
Reverse Recovery Time	$t_{rr}$	$I_F = 100\text{A}$ , $di/dt = -200\text{A}/\mu\text{s}$	—	—	1.2	$\mu\text{s}$
Reverse Recovery Charge	$Q_{rr}$	$I_F = 100\text{A}$ , $di/dt = -200\text{A}/\mu\text{s}$	—	25	—	$\mu\text{C}$

**Thermal and Mechanical Characteristics,  $T_j = 25^\circ\text{C}$  unless otherwise specified**

Characteristics	Symbol	Test Conditions	Min.	Typ.	Max.	Units
Thermal Resistance, Junction to Case	$R_{th(j-c)Q}$	Per Diode	—	—	0.12	$^\circ\text{C}/\text{W}$
Thermal Resistance, Case to Sink Lubricated	$R_{th(c-s)Q}$	Per Module	—	—	0.05	$^\circ\text{C}/\text{W}$

QR\_3310001  
**Fast Recovery Diode Module**  
 100 Amperes/3300 Volts

**MAXIMUM ON-STATE FORWARD VOLTAGE DROP CHARACTERISTICS**  
 ( $T_j = 150^\circ\text{C}$ )

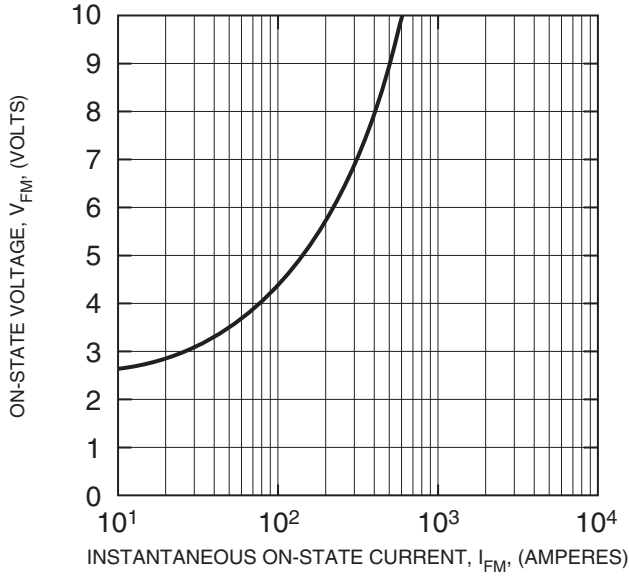

**MAXIMUM TRANSIENT THERMAL IMPEDANCE CHARACTERISTICS**  
 (JUNCTION TO CASE)

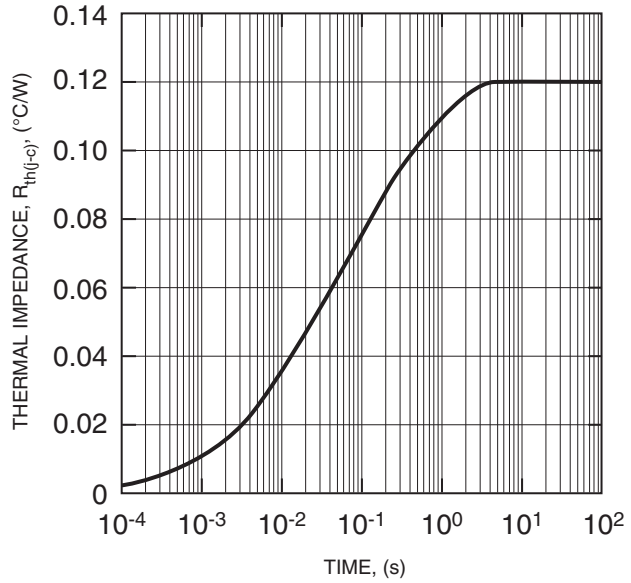

**MAXIMUM ON-STATE POWER DISSIPATION**  
 (SINUSOIDAL WAVEFORM)

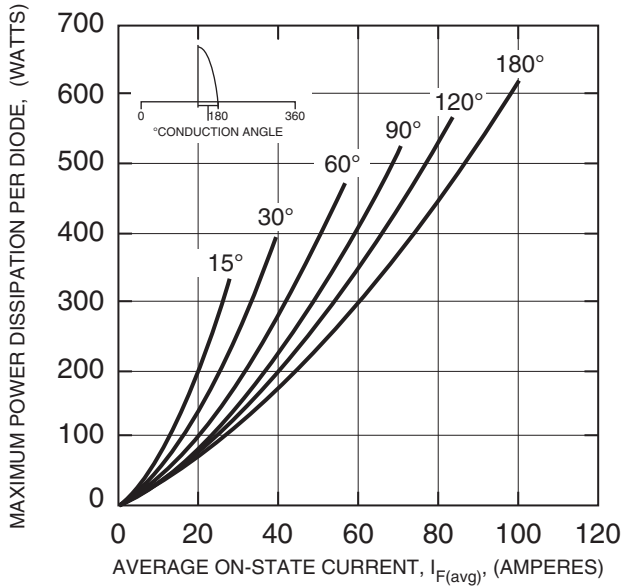

**MAXIMUM ALLOWABLE CASE TEMPERATURE**  
 (SINUSOIDAL WAVEFORM)

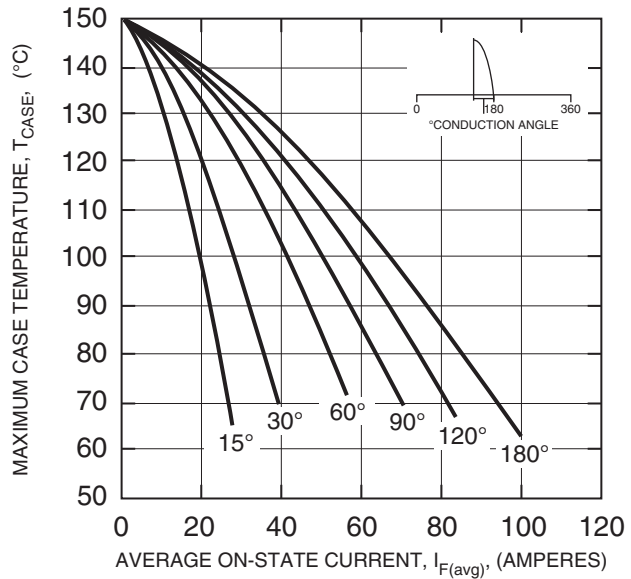

QR\_3310001  
**Fast Recovery Diode Module**  
 100 Amperes/3300 Volts

**MAXIMUM ON-STATE  
 POWER DISSIPATION  
 (RECTANGULAR WAVEFORM)**

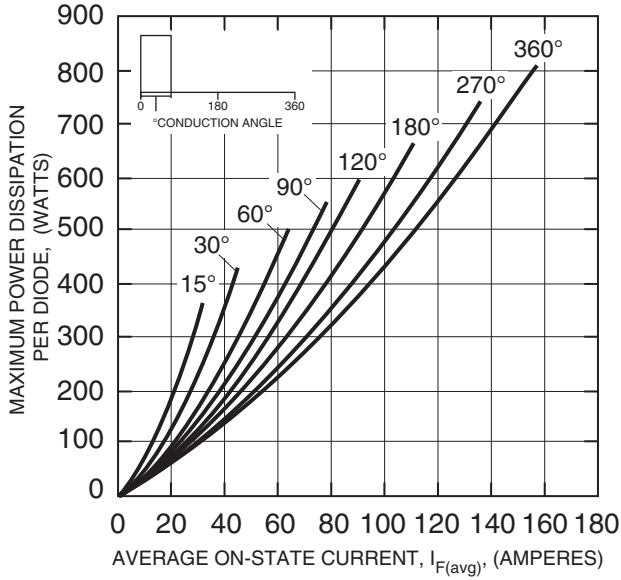

**MAXIMUM ALLOWABLE  
 CASE TEMPERATURE  
 (RECTANGULAR WAVEFORM)**

