

Features

Unregulated Converters

- UL/CSA and EN Safety certified
- EN-60601 for Medical Applications
- Isolation 6.4kVDC
- Optional Continuous Short Circuit Protected
- /X2 Option for >9mm Input/Output Clearance
- Suitable for IGBT Applications

Description

The RxxPxxS_D Series of DC/DC Converters are certified to UL/CSA-60950 as well as EN60950 and EN60601. This makes them ideal for medical and safety applications where approved isolation is required.

Selection Guide

Part Number SIP 7	Input Voltage (VDC)	Output Voltage (VDC)	Output Current (mA)	Efficiency Std (%)	Max Capacitive Load ⁽¹⁾
RxxP3.3S*	5, 9, 12, 15, 24	3.3	303	70	2200µF
RxxP05S*	5, 9, 12, 15, 24	5	200	70-75	1000µF
RxxP09S*	5, 9, 12, 15, 24	9	111	70-75	1000µF
RxxP12S*	5, 9, 12, 15, 24	12	84	70-75	470µF
RxxP15S*	5, 9, 12, 15, 24	15	66	75-80	470µF
RxxP3.3D*	5, 9, 12, 15, 24	±3.3	±151	70	±1000µF
RxxP05D*	5, 9, 12, 15, 24	±5	±100	70-75	±470µF
RxxP09D*	5, 9, 12, 15, 24	±9	±55	70-75	±470µF
RxxP12D*	5, 9, 12, 15, 24	±12	±41	70-75	±220µF
RxxP15D*	5, 9, 12, 15, 24	±15	±33	75-80	±220µF
RxxP1509D*	12, 24	+15/-9	+33/-56	70-80	±220µF
R05P1509D*	5	+15/-9	±42	70-80	+68µF/-220µF

xx = Input Voltage. Other input and output voltage combinations available on request.

* add Suffix "P" for Continuous Short Circuit Protection, e.g. R05P05S/P, R05P05D/P

* add Suffix "/X2" for single output with alternative pinout, e.g. R05P05S/X2, R05P05S/P/X2

Specifications (measured at $T_A = 25^\circ\text{C}$, nominal input voltage, full load and after warm-up)

Input Voltage Range	±10%	
Output Voltage Accuracy	±5%	
Line Voltage Regulation	1.2%/1% of V_{in} typ.	
Load Voltage Regulation (10% to 100% full load)	3.3, 5V output types	15% max.
	other output types, RxxP1509D	10% max.
Output Ripple and Noise (20MHz BW)	200mVp-p max.	
Operating Frequency	20kHz min. / 50kHz typ. / 85kHz max.	
	RxxP1509D	20kHz min. / 60kHz typ.
Efficiency at Full Load	65% min. / 75% typ.	
Minimum Load = 0%	Specifications valid for 10% minimum load only	
Isolation Voltages	(tested for 1 second)	6400VDC
	(rated for 1 minute**)	3200VAC / 60Hz
Isolation Capacitance	4pF min. / 10pF max.	
Isolation Resistance	15 GΩ min.	
Short Circuit Protection	1 Second	
P-Suffix	Continuous	
Operating Temperature Range (free air convection, without derating)	-40°C to +90°C (see Graph)	
Storage Temperature Range	-55°C to +125°C	
Relative Humidity	95% RH	

continued on next page

ECONOLINE

DC/DC-Converter

with 3 year Warranty

RECOM

1 Watt

SIP 7 Single

& Dual Output



EN-60950-1 Certified
IEC/EN-60601-1 Certified*
CSA/UL-60950-1 Certified*
*** +15/-9 Version excluded**

RxxPxx

Derating-Graph

(Ambient Temperature)

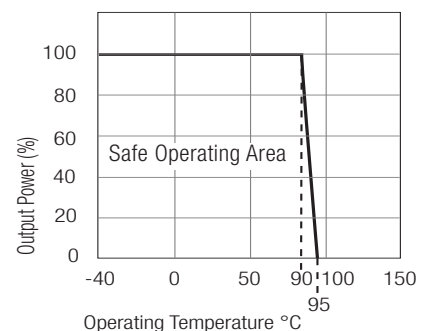

**Any data referred to in this datasheet are of indicative nature and based on our practical experience only. For further details, please refer to our Application Notes.

Refer to Application Notes

Specifications (measured at $T_A = 25^\circ\text{C}$, nominal input voltage, full load and after warm-up)

Package Weight			4.3g
Packing Quantity			25 pcs per Tube
MTBF (+25°C) } (+85°C) }	Detailed Information see Application Notes chapter "MTBF"	using MIL-HDBK 217F	2974 x 10 ³ hours
		using MIL-HDBK 217F	728 x 10 ³ hours
Certifications			
UL/cUL General Safety	Report: E358085-A8	UL 60950-1 2nd Ed.	
EN General Safety	Report: SPCLVD1305069	EN60950-1:2006 + A12: 2011	
EN Medical Safety	Report: SPCMDD1205098-4	IEC/EN60601-1:2006, 3rd Edition	

Notes

Note 1 Maximum capacitive load is defined as the capacitive load that will allow start up in under 1 second without damage to the converter.

Tolerance Envelope

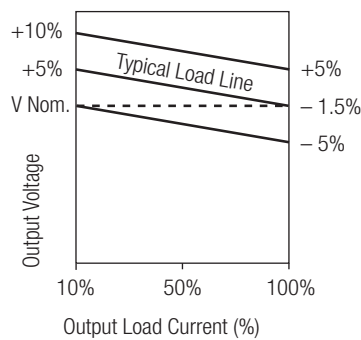

Typical Characteristics

RxxPxx

RxxP05S
RxxP09S

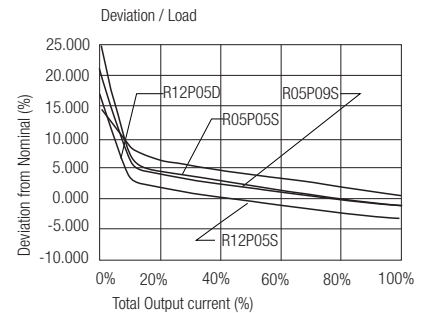
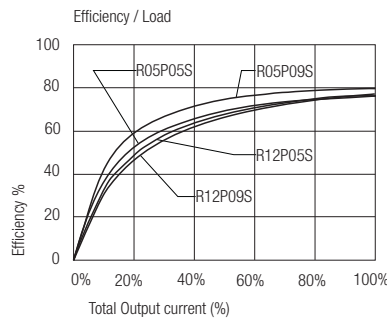

RxxP05D
RxxP09D

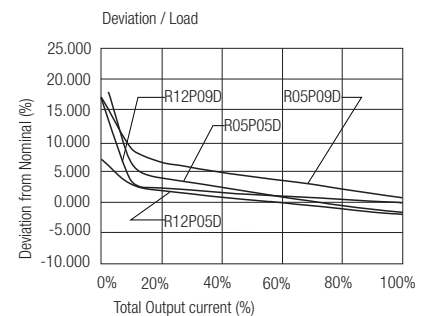
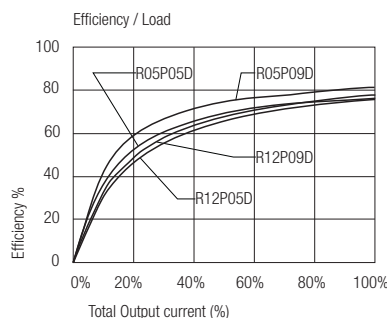

Typical Characteristics

RxxP12S, RxxP15S

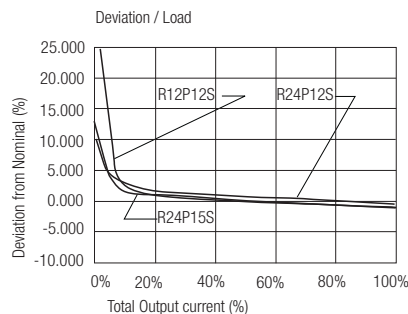
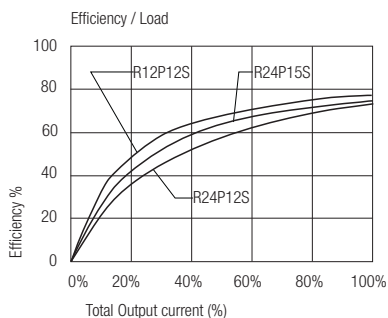

RxxP12D, RxxP15D

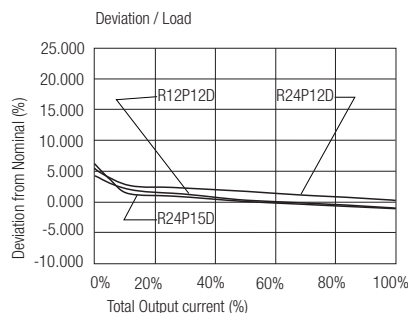
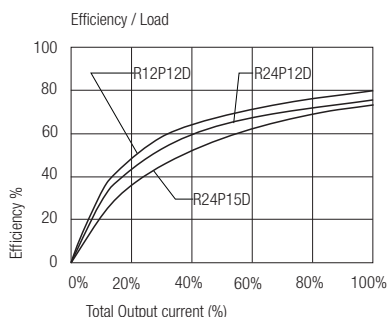

RxxPxx

EMC Filter Suggestions for EN55022 Class A and B

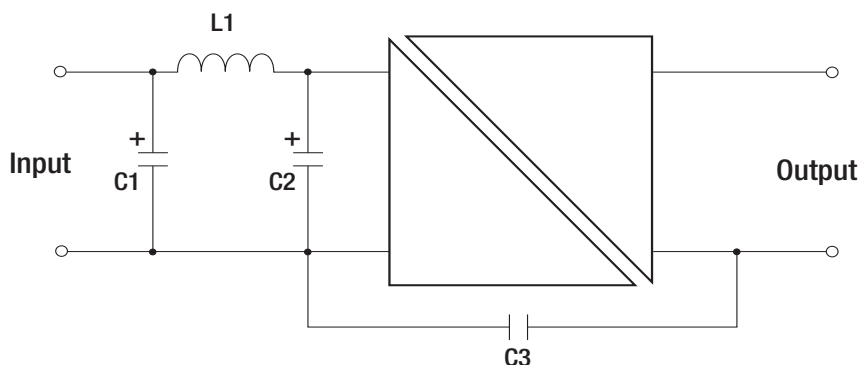

	C1	L1	C2	C3
EN55022 Class A	10 μ F	NA	NA	NA
EN55022 Class B	10 μ F	470 μ H WE 7447471471	10 μ F	2n2F 8kV Vishay HGZ222MBP

Application

IGBT Application Circuit

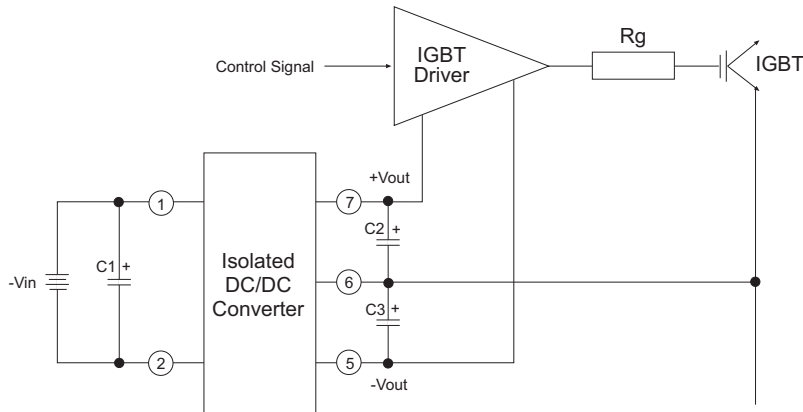

Package Style and Pinning (mm)

7 PIN SIP Package

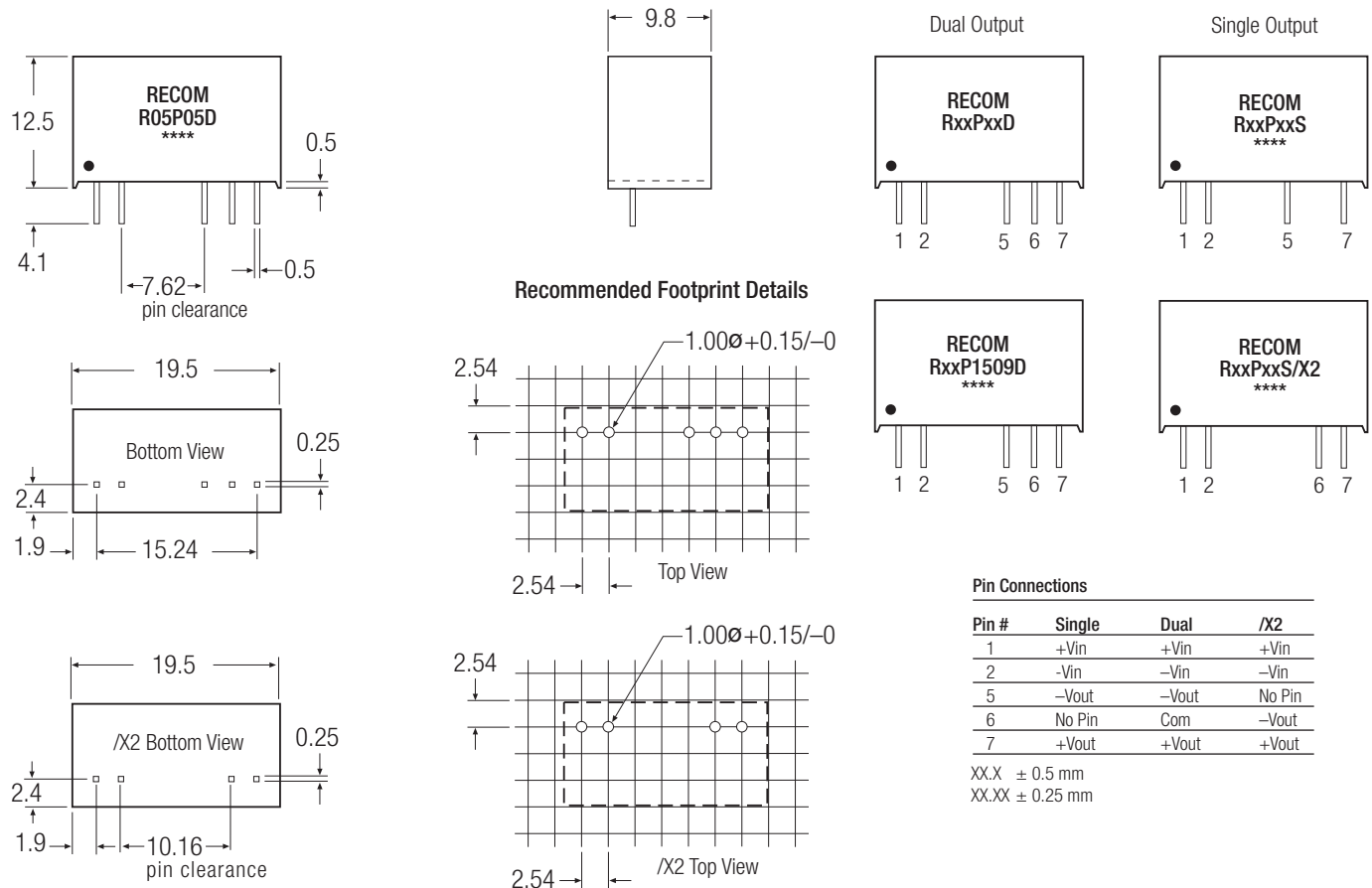

Pin Connections

Pin #	Single	Dual	/X2
1	+Vin	+Vin	+Vin
2	-Vin	-Vin	-Vin
5	-Vout	-Vout	No Pin
6	No Pin	Com	-Vout
7	+Vout	+Vout	+Vout

XX.X \pm 0.5 mm
XX.XX \pm 0.25 mm

RxxPxx

The product information and specifications are subject to change without prior notice. RECOM products are not authorized for use in safety-critical applications (such as life support) without RECOM's explicit written consent. A safety-critical application is defined as an application where a failure of a RECOM product may reasonably be expected to endanger or cause loss of life, inflict bodily harm or damage property. The buyer shall indemnify and hold harmless RECOM, its affiliated companies and its representatives against any damage claims in connection with the unauthorized use of RECOM products in such safety-critical applications.