

Features

Unregulated Converters

- UL/CSA and EN Safety certified
- EN-61010 for Test, Measurement and Lab Use
- EN-60601 for Medical Applications
- Reinforced Isolation 6.4kVDC or 8kVDC
- Optional Continuous Short Circuit Protected
- Unique Reinforced Isolation Transformer System
- /X2 Option for >9mm Input/Output Clearance

Description

The RxxPxxS_D Series of DC/DC Converters are certified to UL/CSA-60950. This makes them ideal for safety applications where approved or reinforced isolation is required. The reinforced versions are also EN61010-1 certified for Lab Equipment Safety.

Selection Guide

Part Number SIP 7	Reinforced Isolation (kVDC)	Input Voltage (VDC)	Output Voltage (VDC)	Output Current (mA)	Efficiency Std (%)	Max Capacitive Load ⁽¹⁾
RxxP3.3S	/R6.4 & /R8	5, 9, 12, 15, 24	3.3	303	70~80	2200µF
RxxP05S	/R6.4 & /R8	5, 9, 12, 15, 24	5	200	75-80	1000µF
RxxP09S	/R6.4 & /R8	5, 9, 12, 15, 24	9	111	75-82	1000µF
RxxP12S	/R6.4 & /R8	5, 9, 12, 15, 24	12	84	75-82	470µF
RxxP15S	/R6.4 & /R8	5, 9, 12, 15, 24	15	66	75-83	470µF
RxxP3.3D	/R6.4 & /R8	5, 9, 12, 15, 24	±3.3	±151	72-79	±1000µF
RxxP05D	/R6.4 & /R8	5, 9, 12, 15, 24	±5	±100	75-82	±470µF
RxxP09D	/R6.4 & /R8	5, 9, 12, 15, 24	±9	±55	75-82	±470µF
RxxP12D	/R6.4 & /R8	5, 9, 12, 15, 24	±12	±41	75-82	±220µF
RxxP15D	/R6.4 & /R8	5, 9, 12, 15, 24	±15	±33	75-83	±220µF

xx = Input Voltage. Other input and output voltage combinations available on request.

* add Suffix "P" for Continuous Short Circuit Protection, e.g. R05P05S/P, R05P05D/P

* add Suffix "/X2" for single output with alternative pinout, e.g. R05P05S/X2, R05P05S/P/X2

* add Suffix "/R6.4" or "/R8" for Reinforced Isolation, e.g. R05P05D/R6.4, R05P05S/P/X2/R8

Specifications (measured at T_A = 25°C, nominal input voltage, full load and after warm-up)

Input Voltage Range	±10%	
Output Voltage Accuracy	±5%	
Line Voltage Regulation	1.2%/1% of Vin typ.	
Load Voltage Regulation (10% to 100% full load)	3.3, 5V output types other output types	15% max. 10% max.
Output Ripple and Noise (20MHz BW)	200mVp-p max.	
Operating Frequency	20kHz min. / 50kHz typ. / 85kHz max.	
Efficiency at Full Load	65% min. / 75% typ.	
Minimum Load = 0%	Specifications valid for 10% minimum load only.	
Reinforced Isolation /R6.4	(tested for 1 second) (rated for 1 minute**)	6400VDC 3200VAC / 60Hz
Reinforced Isolation /R8	(tested for 1 second) (rated for 1 minute**)	8000VDC 4000VAC / 60Hz
Isolation Capacitance	4pF min. / 10pF max.	
Isolation Resistance	15 GΩ min.	
Short Circuit Protection	1 Second	
P-Suffix	Continuous	
Operating Temperature Range (free air convection)	-40°C to +85°C (see Graph)	
Storage Temperature Range	-55°C to +125°C	
Relative Humidity	95% RH	
Package Weight	4.3g	
Packing Quantity	25 pcs per Tube	

continued on next page

ECONOLINE

DC/DC-Converter

with 3 year Warranty

RECOM

1 Watt

SIP 7 Single

& Dual Output



EN-60950-1 Certified
EN-60601-1 Certified
UL/CSA 60950-1 Certified
UL-60601-1 Certified
EN-61010-1 Certified
IEC-60601-1 CB Report

RxxPxx/R

Derating-Graph (Ambient Temperature)

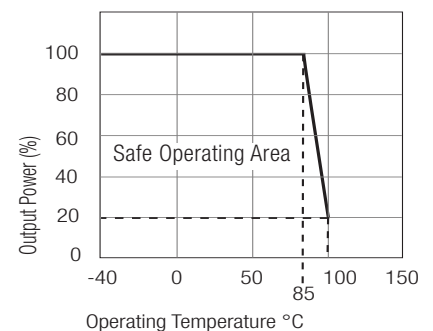

**Any data referred to in this datasheet are of indicative nature and based on our practical experience only. For further details, please refer to our Application Notes.

Refer to Application Notes

Specifications (measured at $T_A = 25^\circ\text{C}$, nominal input voltage, full load and after warm-up)

Potting Material	Silicone Rubber Compound (UL94V-0)		
MTBF (+25°C)	} Detailed Information see Application Notes chapter "MTBF"	using MIL-HDBK 217F	2974 x 10 ³ hours
(+85°C)		using MIL-HDBK 217F	728 x 10 ³ hours
Reinforced Isolation			
Transformer Clearance	Reinforced Types	5.5 mm min.	
PCB Creepage & Clearance	Reinforced Types	4.6 mm min.	
Certifications			
Measurement, Control and Laboratory Use Safety	Report: T1301251-313	EN 61010-1 : 2010	
CSA General Safety		UL 60950-1 1st Ed. C22.2 No. 60950-1-03	
UL/cUL Medical Safety	Report: E314885-A5	UL60601-1 3rd Edition	
CSA Medical Safety	Report: 2207629	CAN/CSA-22.2 No 601.1-M90	
EN General Safety	Report: SPCLVD1310079-1	EN60950-1 : 2006	
CB/EN Medical Safety	Report: CA-10169-A1-UL	IEC/EN 60601-1 3rd Edition	

Notes

Note 1 Maximum capacitive load is defined as the capacitive load that will allow start up in under 1 second without damage to the converter.

Tolerance Envelope

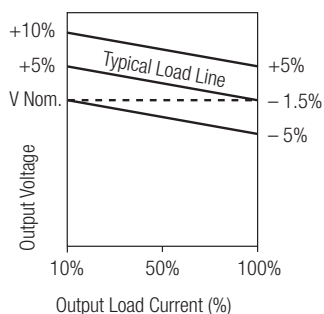

Typical Characteristics - Reinforced Version

RxxP05S/R6.4
RxxP05S/R8

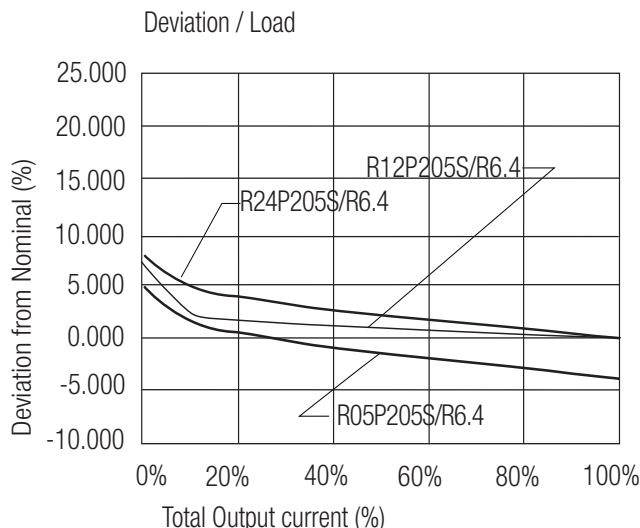
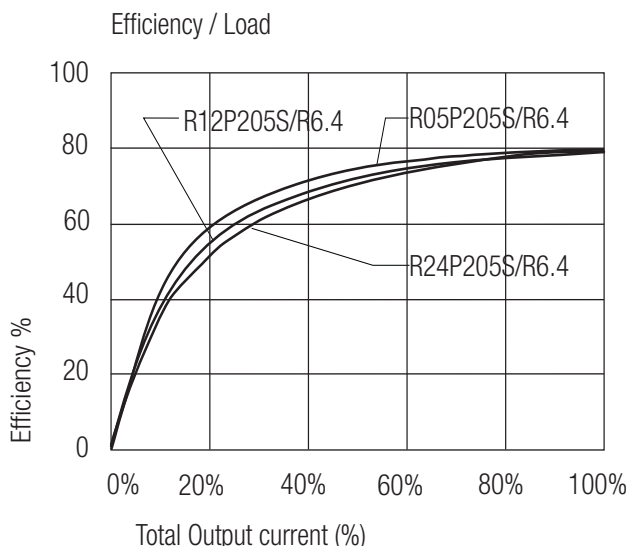

RxxP05D/R6.4 RxxP05D/R8

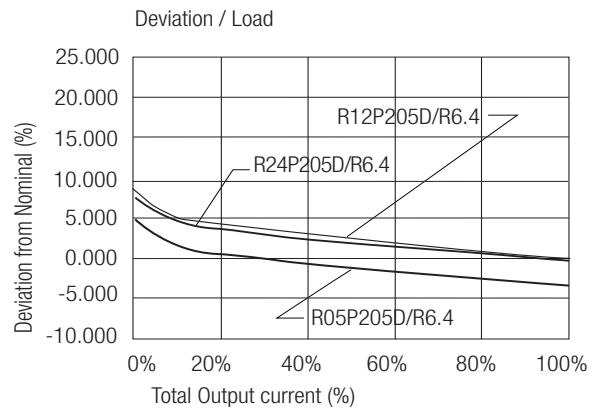
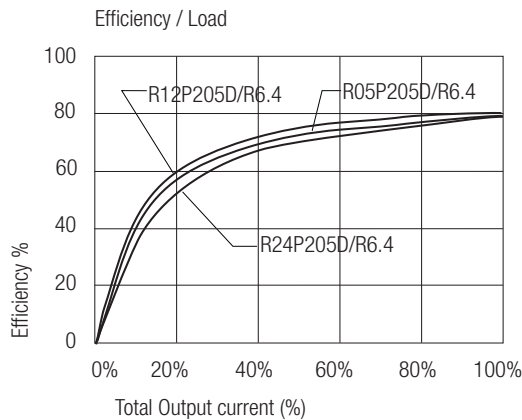

Package Style and Pinning (mm)

7 PIN SIP Package

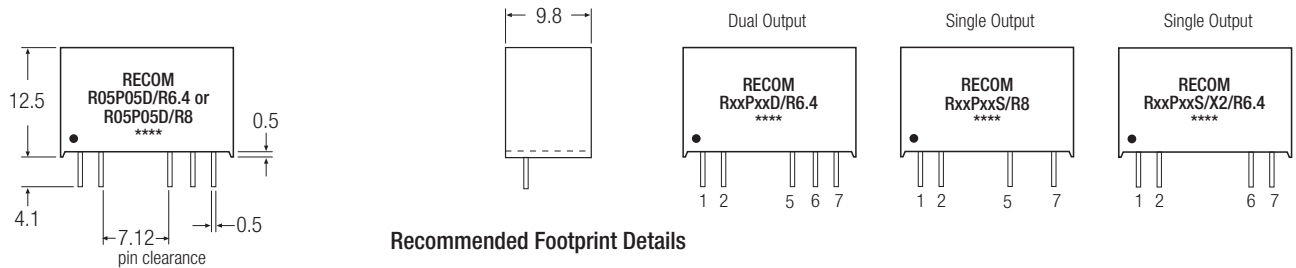

Recommended Footprint Details

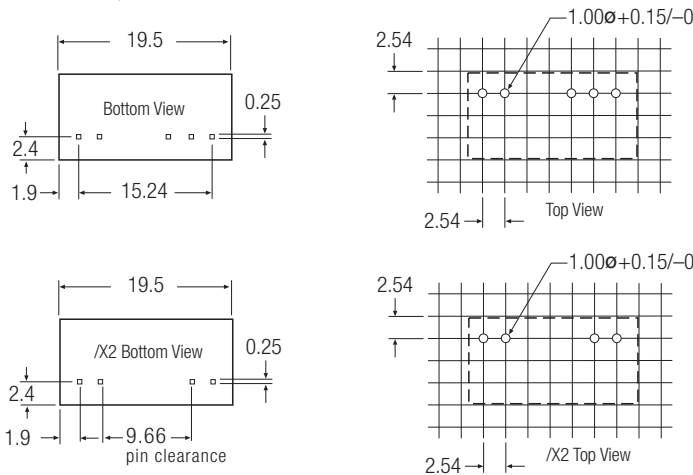

Pin Connections

Pin #	Single	Dual	/X2
1	+Vin	+Vin	+Vin
2	-Vin	-Vin	-Vin
5	-Vout	-Vout	No Pin
6	No Pin	Com	-Vout
7	+Vout	+Vout	+Vout

XX.X ± 0.5 mm
XX.XX ± 0.25 mm