

Automatic Mode Shift Dual 150mA LDO

EA-0911-2006

OUTLINE

The R5326X Series are CMOS-based voltage regulator ICs with high output voltage accuracy, Typ. 5.5 μ A low supply current, and remarkably improved transient response compared with the conventional low supply current voltage regulators. The supply current of IC itself is automatically shifts between fast mode and low power mode depending on the load current. (The current threshold is fixed internally.) Each of these voltage regulator ICs consists of a voltage reference unit, an error amplifier, resistors for setting the output voltage, a current limit circuit for preventing from the destruction by an over current, and so on.

The chip enable function realizes the standby mode with ultra low supply current.

Since the packages for these ICs are SOT-23-6 and PLP1820-6, and chip size package, WLCSP-6, 2ch LDO regulators are included in each package, high density mounting of the ICs on boards is possible.

FEATURES

- Low Supply Current.....Typ. 5.5 μ A (VR1, VR2) (I_{out}=0mA)
.....Typ. 50 μ A (VR1, VR2) (I_{out}=10mA)
- Standby Mode.....Typ. 0.1 μ A (VR1, VR2)
- Low Dropout Voltage.....Typ. 0.19V (I_{OUT}=150mA Output Voltage=3.0V Type)
- High Ripple Rejection.....Typ. 70dB (f=1kHz)
.....Typ. 60dB (f=10kHz)
- Excellent Line Regulation.....Typ. 0.02%/V
- Small PackagesSOT-23-6/PLP1820-6 /WLCSP-6
- Output VoltageStepwise setting with a step of 0.1V in the range of 0.8V to 4.2V is possible
- Input Voltage1.4V to 6.0V
- Built-in chip enable circuit (A/B: active high)
- Built-in fold-back protection circuit.....Typ. 50mA (Current at short mode)
- Ceramic Capacitor is recommended.1.0 μ F to 3.3 μ F (Depending on V_{IN} and set V_{OUT}. Refer to the electrical characteristics table.)

APPLICATIONS

- Power source for handheld communication equipment.
- Power source for electrical appliances such as cameras, VCRs and camcorders.
- Power source for battery-powered equipment.

BLOCK DIAGRAMS

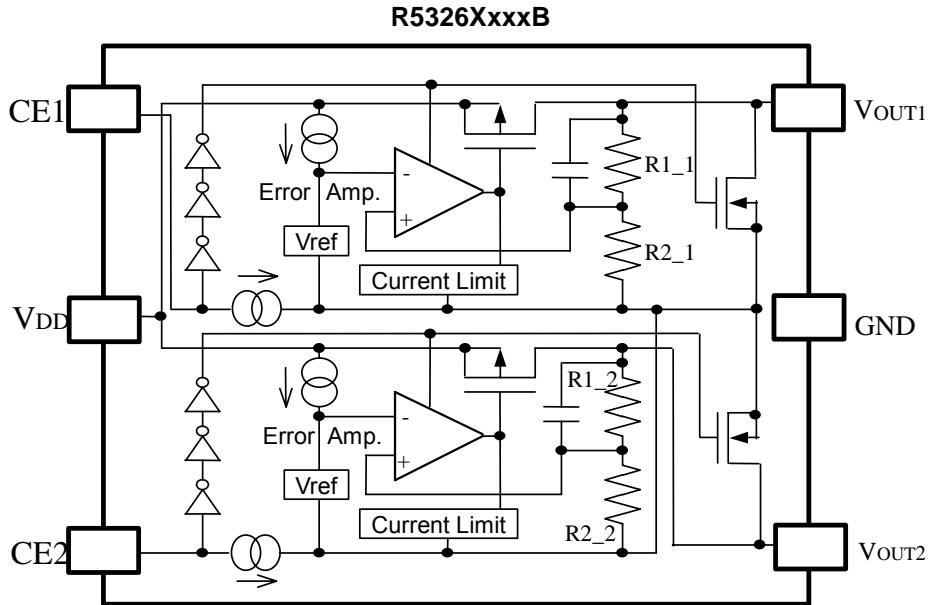

SELECTION GUIDE

The output voltage, mask option, and the taping type for the ICs can be selected at the user's request. The selection can be made with designating the part number as shown below;

R5326X**xxxx-xx**-(F) ←Part Number
 ↑↑ ↑↑ ↑
 a b c d e

Code	Contents
a	Designation of Package Type: N: SOT23-6 K: PLP1820-6 Z: WLCSP-6
b	Setting combination of 2ch Output Voltage (V _{OUT}): Serial Number for Voltage Setting. Stepwise setting with a step of 0.1V in the range of 0.8V to 4.2V is possible for each channel.
c	Designation of Mask Option: A version: without auto discharge function at OFF state. B version: with auto discharge function at OFF state.
d	Designation of Taping Type: Ex. TR (refer to Taping Specifications; for SOT23-6 and PLP1820-6) E2 (for WLCSP-6)
e	SOT23-6 and WLCSP6: -F (Pb-free plating) PLP1820-6: no extension (No plating, genuine Pb-free)

PIN CONFIGURATION

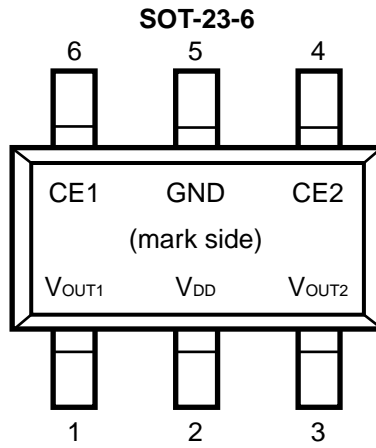

PLP1820-6

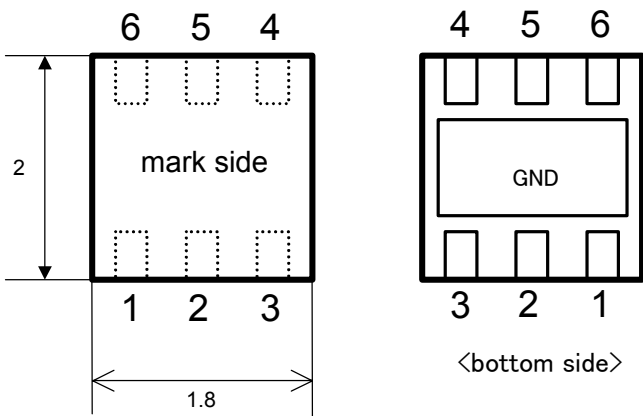

WLCSP-6

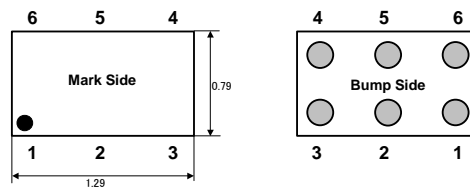

PIN DESCRIPTION

SOT23-6

Pin No.	Symbol	Description
1	V _{OUT1}	Output Pin 1
2	V _{DD}	Input Pin
3	V _{OUT2}	Output Pin 2
4	CE2	Chip Enable Pin 2
5	GND	Ground Pin
6	CE1	Chip Enable Pin 1

PLP1820-6

Pin No.	Symbol	Description
1	V _{OUT2}	Output Pin 2
2	V _{DD}	Input Pin
3	V _{OUT1}	Output Pin 1
4	CE1	Chip Enable Pin 1
5	GND	Ground Pin
6	CE2	Chip Enable Pin 2

WLCSP-6

Pin No.	Symbol	Description
1	V _{OUT1}	Output Pin 1
2	V _{DD}	Input Pin
3	V _{OUT2}	Output Pin 2
4	CE2	Chip Enable Pin 2
5	GND	Ground Pin
6	CE1	Chip Enable Pin 1

ABSOLUTE MAXIMUM RATINGS

Symbol	Item	Rating	Unit
V_{IN}	Input Voltage	6.5	V
V_{CE}	Input Voltage (CE Pin)	-0.3~6.5	V
V_{OUT}	Output Voltage	-0.3~ $V_{IN}+0.3$	V
I_{OUT1}	Output Current 1	200	mA
I_{OUT2}	Output Current 2	200	mA
P_D	Power Dissipation (SOT-23-6)	250	mW
	Power Dissipation (PLP1820-6)*Note1	880	
	Power Dissipation (WLCSP-6)*Note1	633	
T_{opt}	Operating Temperature Range	-40~85	°C
T_{stg}	Storage Temperature Range	-55~125	°C

Note1: Mounted on board. Conditions: Board material FR4, Board dimensions 40*40*1.6(mm)

Metal rate: 50%(2-layer) with thermal via holes:(ϕ 0.54mm*30 for PLP1820-6, ϕ 0.5mm*44 for WLCSP-6), wind velocity=0m/s

ELECTRICAL CHARACTERISTICS

R5326XxxxA/B

Topt=25°C

Symbol	Item	Conditions	Min.	Typ.	Max.	Unit
V_{OUT}	Output Voltage (*1)	$V_{IN}=\text{Set } V_{OUT}+1V$ $I_{OUT}=1mA$	V_{OUT} $\times 0.99$ (-15mV)		V_{OUT} $\times 1.01$ (+15mV)	V
I_{OUT}	Output Current	$V_{IN}-V_{OUT}=1.0V$	150			mA
$\Delta V_{OUT}/\Delta I_{OUT}$	Load Regulation	$V_{IN}=\text{Set } V_{OUT}+1V$ $1mA \leq I_{OUT} \leq 150mA$			80	mV
V_{DIF}	Dropout Voltage	Refer to the ELECTRICAL CHARACTERISTICS by OUTPUT VOLTAGE				
I_{SS0}	Supply Current	$V_{IN}=\text{Set } V_{OUT}+1V, I_{OUT}=0mA$		5.5	16	μA
I_{SS10}	Supply Current	$V_{IN}=\text{Set } V_{OUT}+1V, I_{OUT}=10mA$		50		μA
$I_{standby}$	Supply Current (Standby)	$V_{IN}=\text{Set } V_{OUT}+1V, V_{CE}=\text{GND}$		0.1	1.0	μA
I_{OUTH}	High Mode Current threshold	$V_{IN}=\text{Set } V_{OUT}+1V$ $I_{OUT}=1\mu A \text{ to } 30mA$		3		mA
I_{OUTL}	ECO Mode Current threshold	$V_{IN}=\text{Set } V_{OUT}+1V$ $I_{OUT}=30mA \text{ to } 1\mu A$		0.6		mA
$\Delta V_{OUT}/\Delta V_{IN}$	Line Regulation	Set $V_{OUT}+0.5V \leq V_{IN} \leq 6V$ $I_{OUT}=30mA$	-0.20	0.02	0.20	%/V
RR	Ripple Rejection	Ripple 0.2Vp-p, $V_{IN}=\text{Set } V_{OUT}+1V, I_{OUT}=30mA$ $f=1kHz$ $f=10kHz$ (In case that $V_{OUT} < 1.5V$, $V_{IN}=\text{Set } V_{OUT}+1.5V$)		70 60		dB
V_{IN}	Input Voltage		1.4		6.0	V
$\Delta V_{OUT}/\Delta T$	Output Voltage Temperature Coefficient	$I_{OUT}=30mA$ $-40^\circ C \leq T_{opt} \leq 85^\circ C$		± 100		ppm/ $^\circ C$
I_{lim}	Short Current Limit	$V_{OUT}=0V$		50		mA
R_{PD}	CE Pull-down Constant Current		0.15	0.30	0.45	μA
V_{CEH}	CE Input Voltage "H"		1.0		6.0	V
V_{CEL}	CE Input Voltage "L"		0.0		0.4	V
en	Output Noise	BW=10Hz to 100kHz		30		μV_{rms}
R_{LOW}	Low Output Nch Tr. ON Resistance (of B version)	$V_{CE}=0V$		40		Ω

(*1) While $V_{out} \leq 1.5V$, the tolerance is $\pm 15mV$

ELECTRICAL CHARACTERISTICS by OUTPUT VOLTAGE

T_{opt}=25°C

Output Voltage V _{OUT} (V)	Dropout Voltage		
	V _{DIF} (V)		
	Condition	Typ.	Max.
0.8≤V _{OUT} <0.9	I _{OUT} =150mA	0.62	0.87
0.9≤V _{OUT} <1.0		0.58	0.78
1.0≤V _{OUT} <1.2		0.48	0.69
1.2≤V _{OUT} <1.5		0.40	0.59
1.5≤V _{OUT} <2.0		0.31	0.48
2.0≤V _{OUT} <2.8		0.22	0.37
2.8≤V _{OUT}		0.19	0.27

* Recommended Ceramic capacitor for Output:

		Minimum Input Voltage	
		1.4V≤ V _{INMIN} <1.65V	1.65 V≤ V _{INMIN}
Output Voltage Range	0.8V≤V _{OUT} <1.2V	3.3μF or more	2.2μF or more
	1.2V≤V _{OUT} ≤4.2V	3.3μF or more	1.0 μF or more

*Output Capacitors

3.3μF (Murata) GRM219B31A335KE18B

2.2μF (Murata) GRM155B30J225M

1.0μF (Murata) GRM155B31A105KE15

TEST CIRCUITS

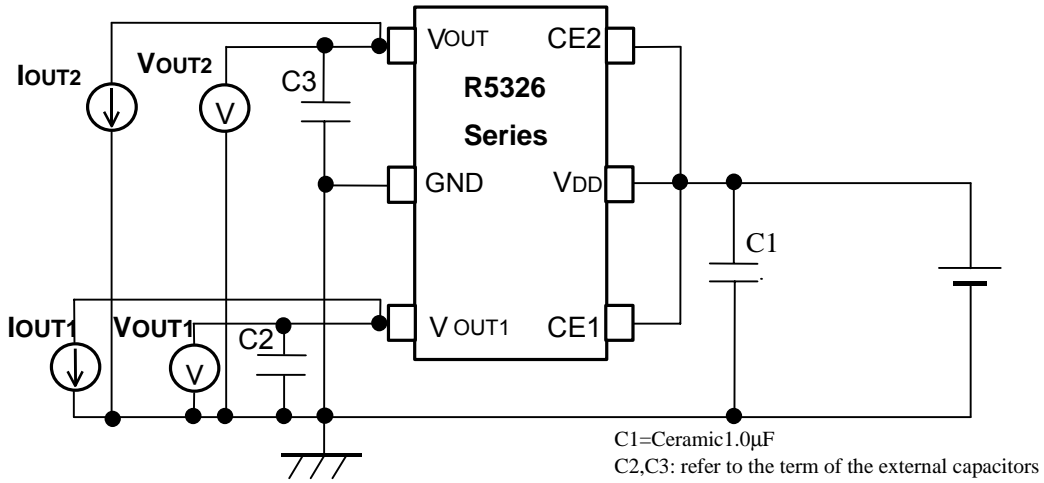

Standard Test Circuit

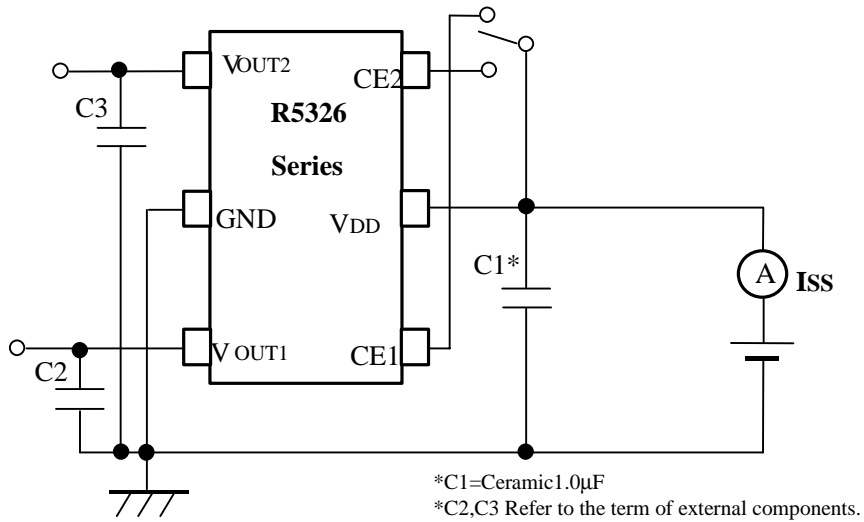

Supply Current

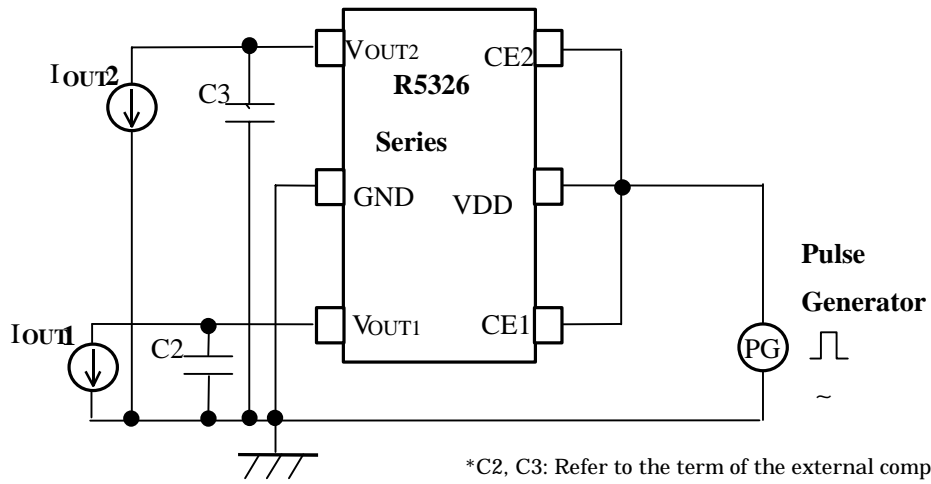

Ripple Rejection, Input Transient Response Test Circuit

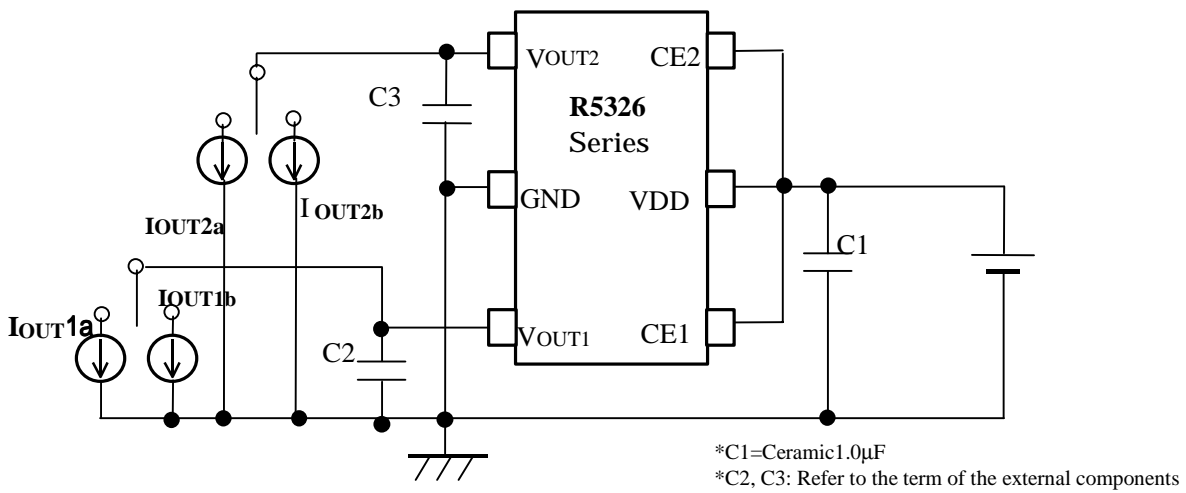

Load Transient Response Test Circuit

TYPICAL APPLICATION

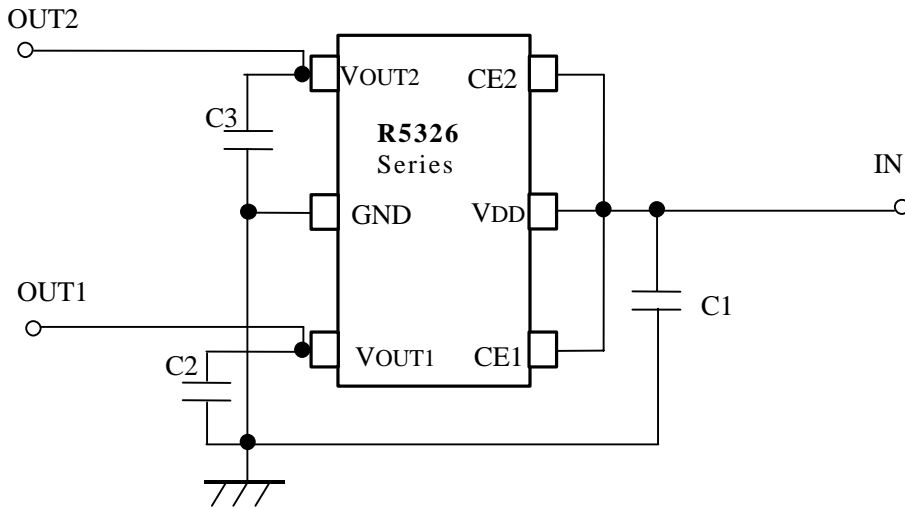

(External Components) Output Capacitor; Ceramic Type
 C1: 1 μ F Ceramic
 C2, C3:

		Minimum Input Voltage	
		$1.4V \leq V_{INMIN} < 1.65V$	$1.65V \leq V_{INMIN}$
Output Voltage Range	$0.8V \leq V_{OUT} < 1.2V$	3.3 μ F or more	2.2 μ F or more
	$1.2V \leq V_{OUT} \leq 4.2V$	3.3 μ F or more	1.0 μ F or more

*Output Capacitors
 3.3 μ F (Murata) GRM219B31A335KE18B
 2.2 μ F (Murata) GRM155B30J225M
 1.0 μ F (Murata) GRM155B31A105KE15

TYPICAL CHARACTERISTICS

1) Output Voltage vs. Output Current
 $V_{OUT}=0.8V$

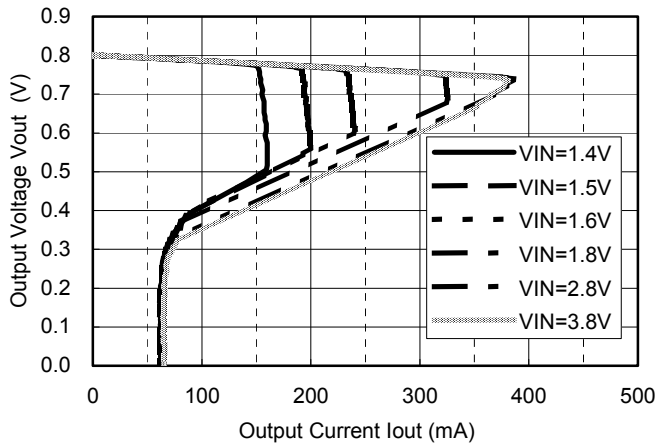

$V_{OUT}=1.5V$

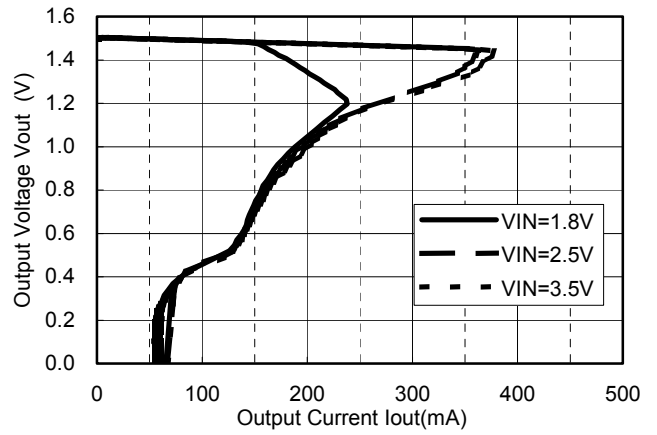

$V_{OUT}=2.8V$

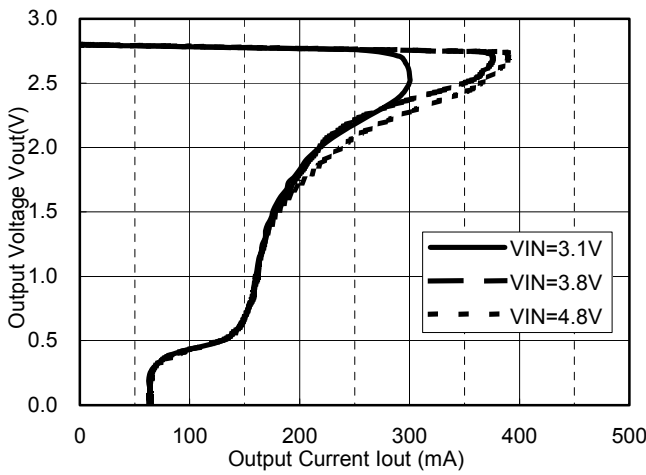

$V_{OUT}=4.0V$

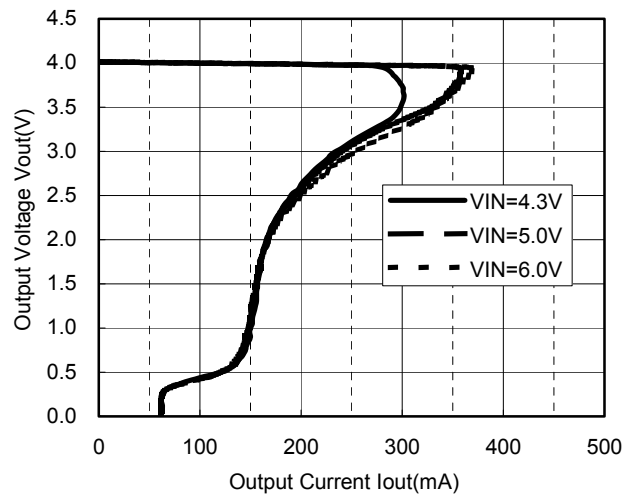

2) Input Voltage vs. Output Voltage
 $V_{OUT}=0.8V$

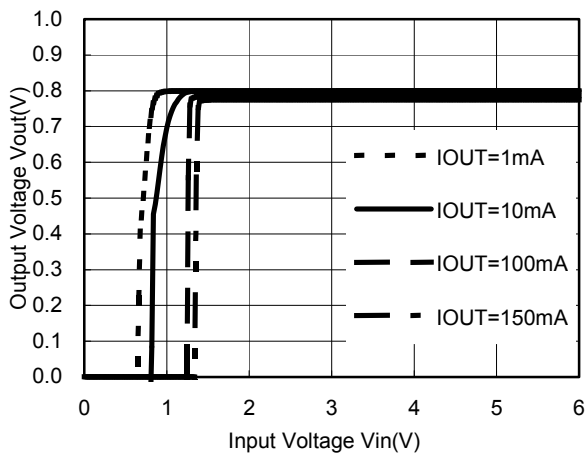

$V_{OUT}=1.5V$

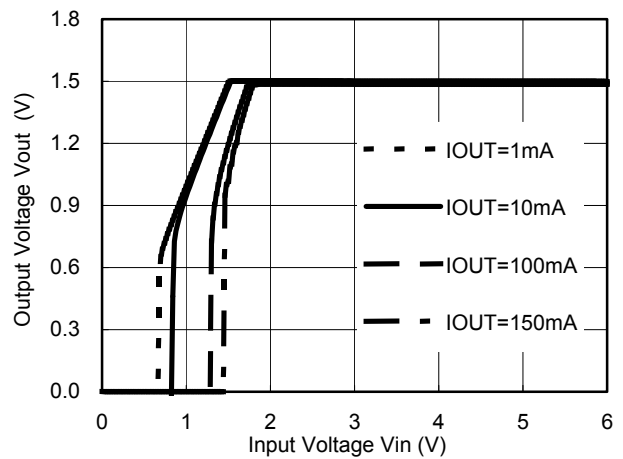

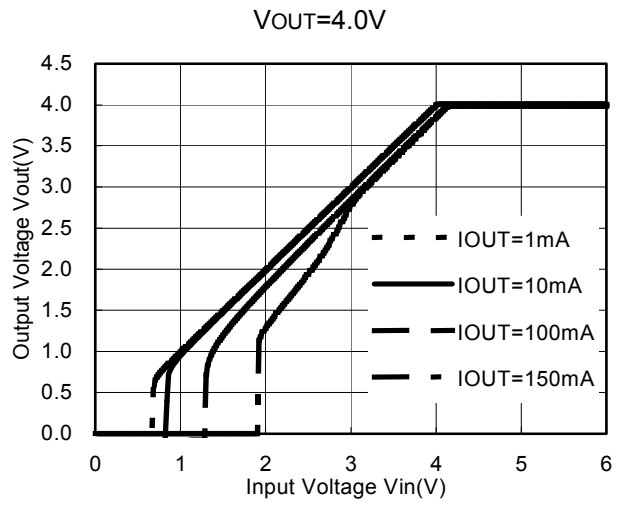
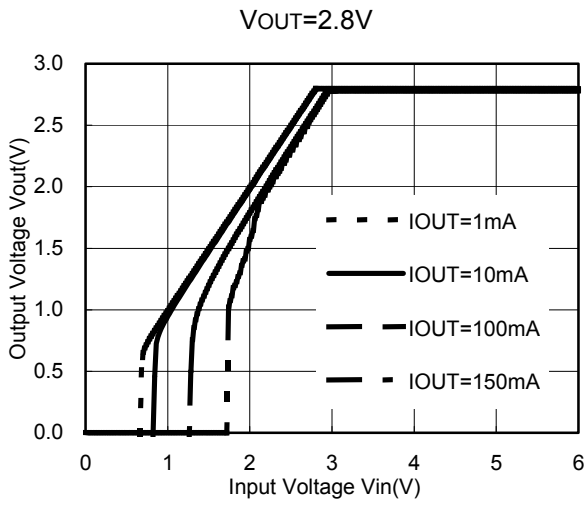

3) GND pin Current vs. Input Voltage
V_{OUT}=0.8V

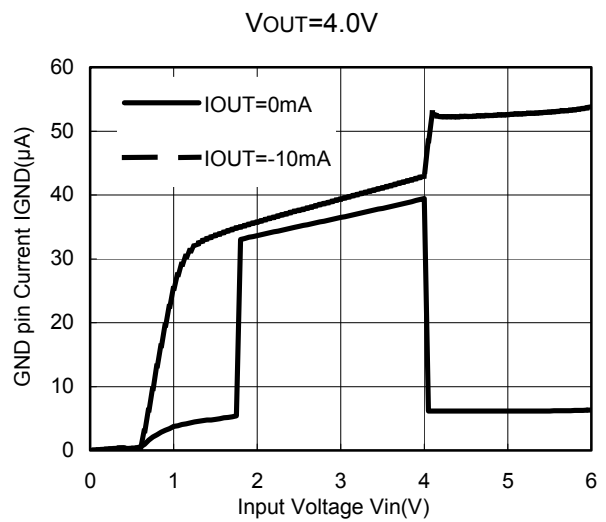
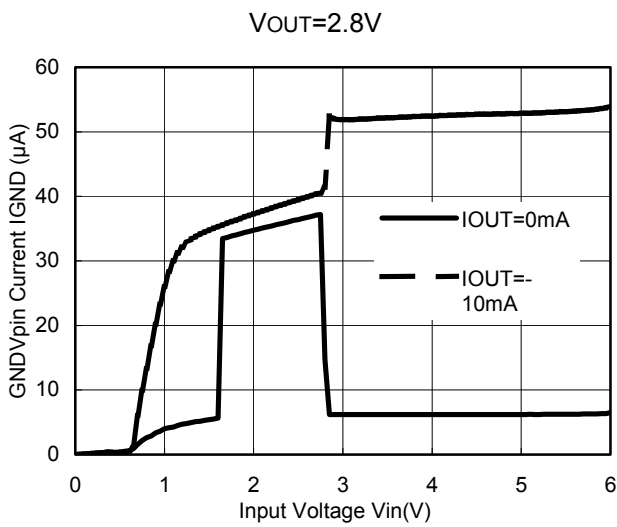
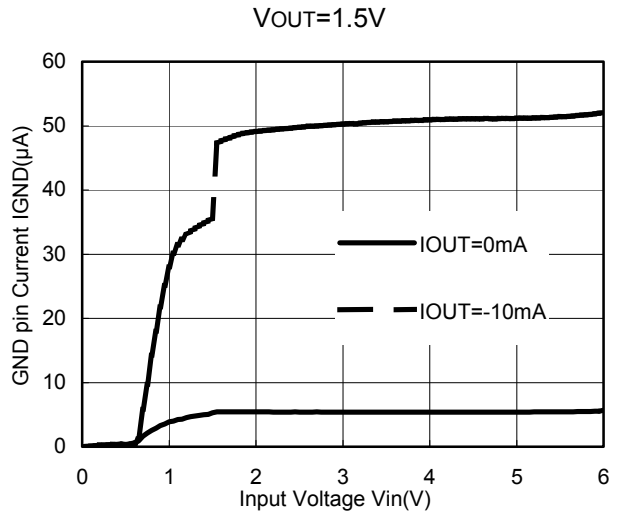
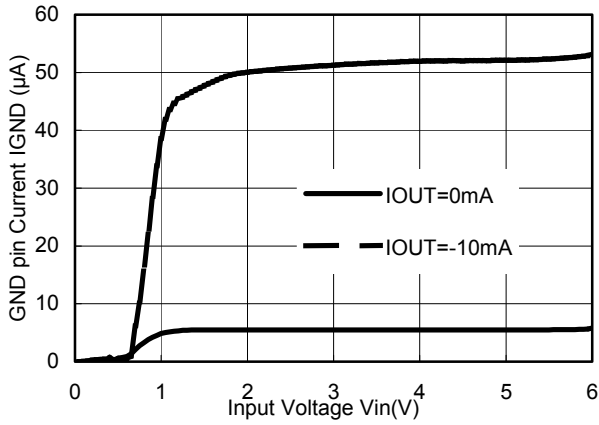

4) GND pin current vs. Output current

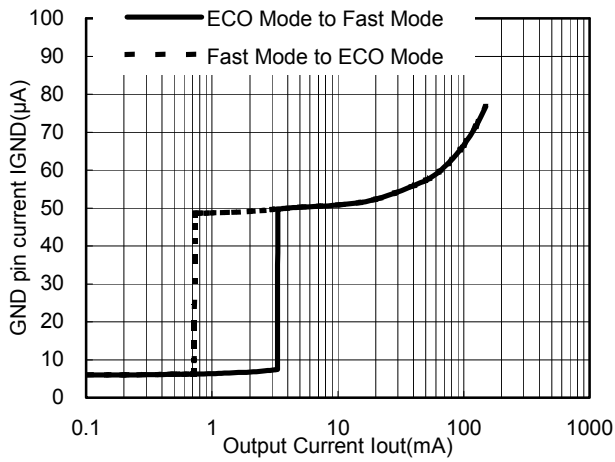

5) Output Voltage vs. Temperature
VOUT=0.8V

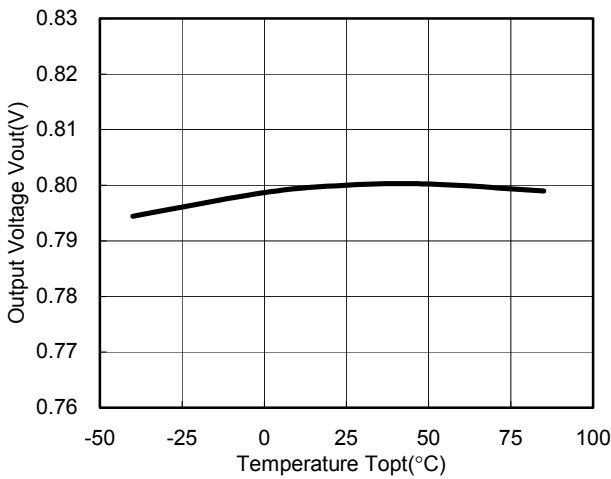

VOUT=1.5V

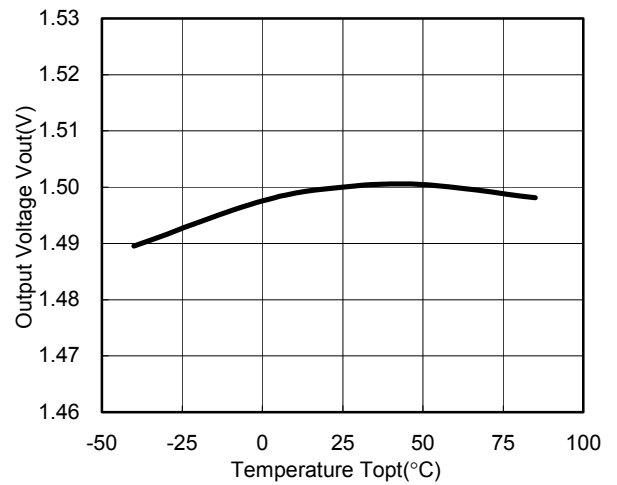

VOUT=2.8V

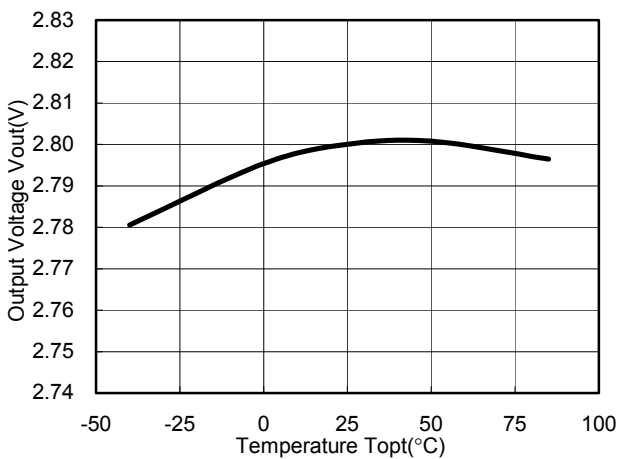

VOUT=4.0V

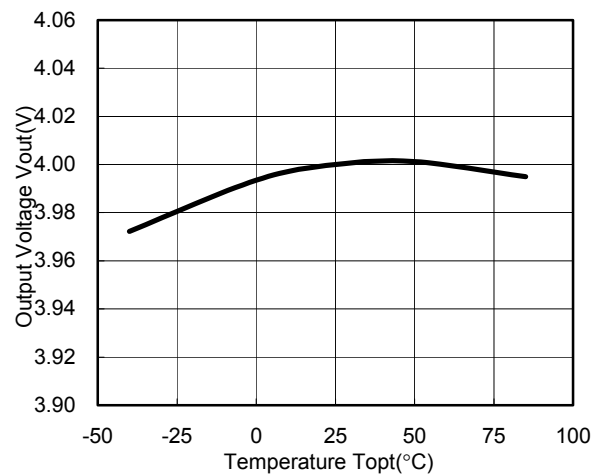

6) Supply Current vs. Temperature (I_{out}=0mA)

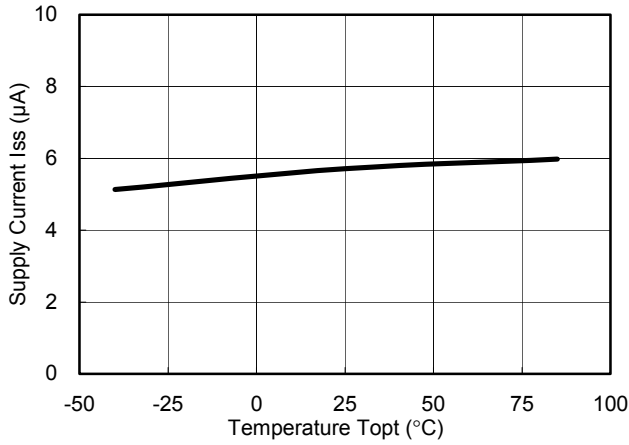

7) Dropout Voltage vs. Output Current
V_{OUT}=0.8V

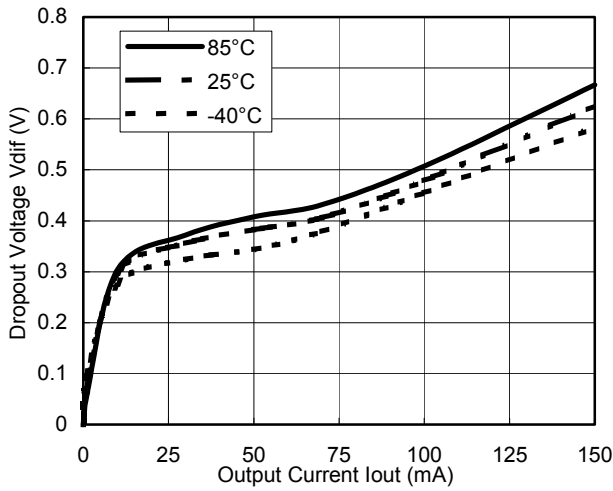

V_{OUT}=0.9V

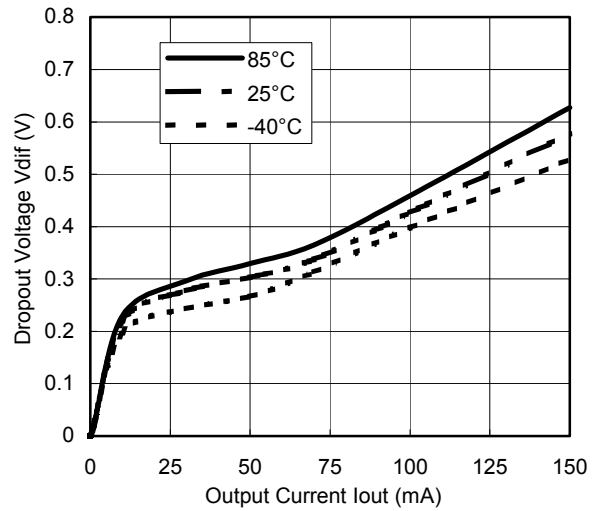

V_{OUT}=1.0V

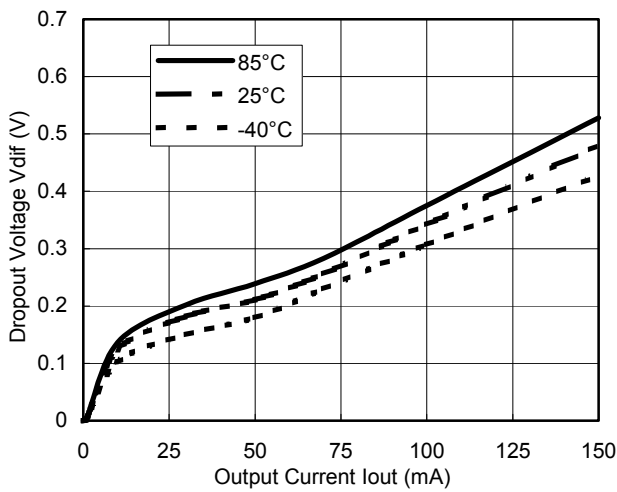

V_{OUT}=1.2V

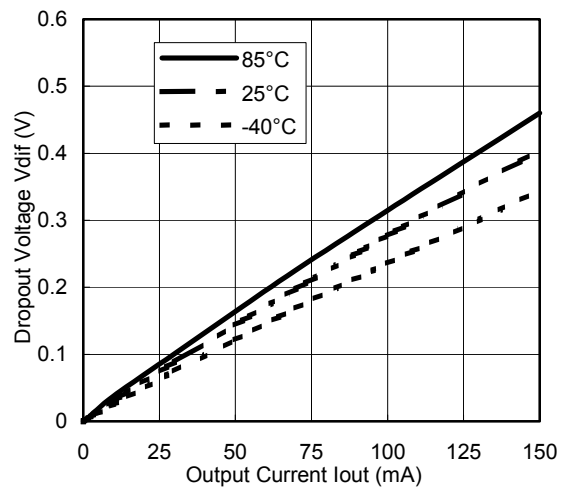

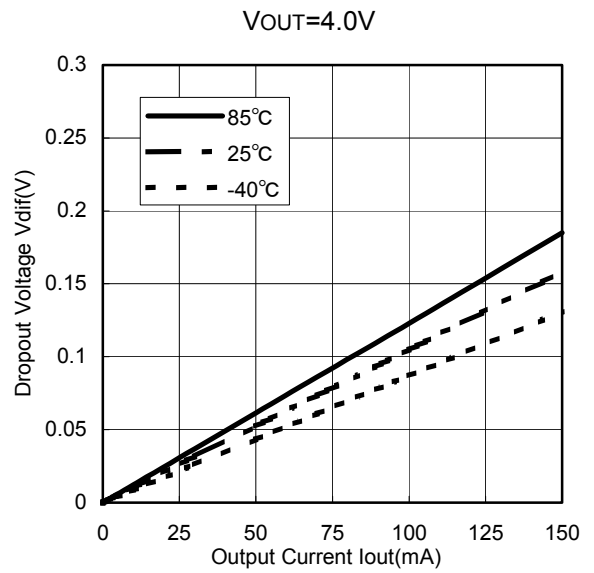
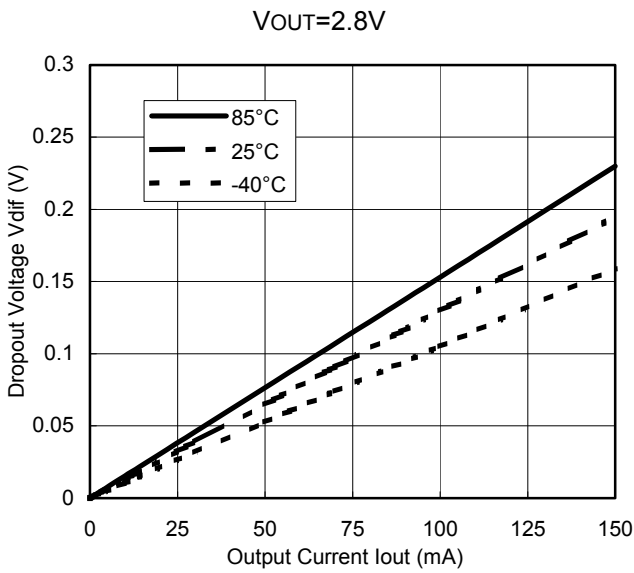
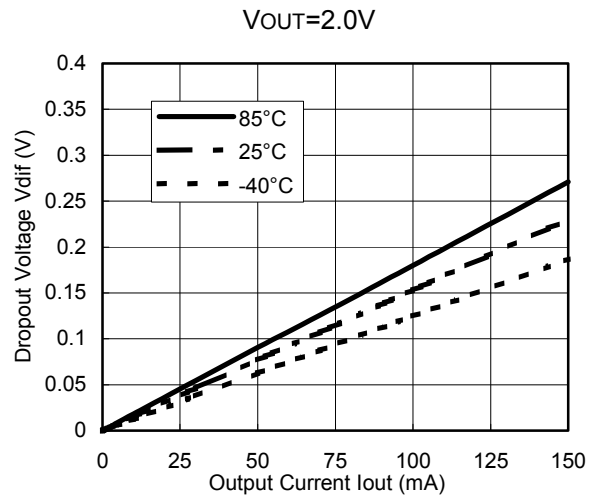
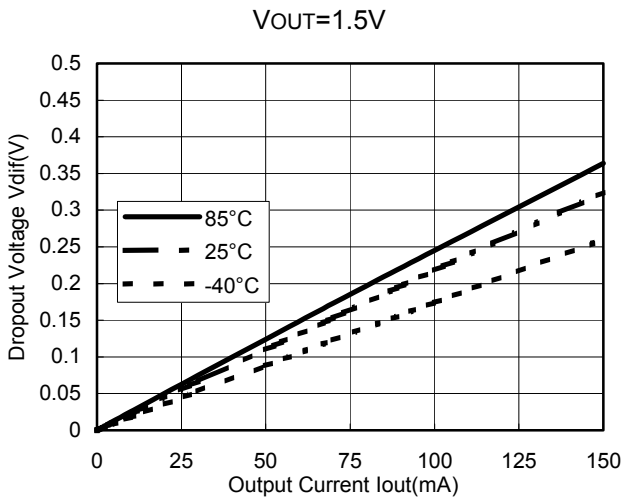

8) Dropout Voltage vs. Set Output Voltage

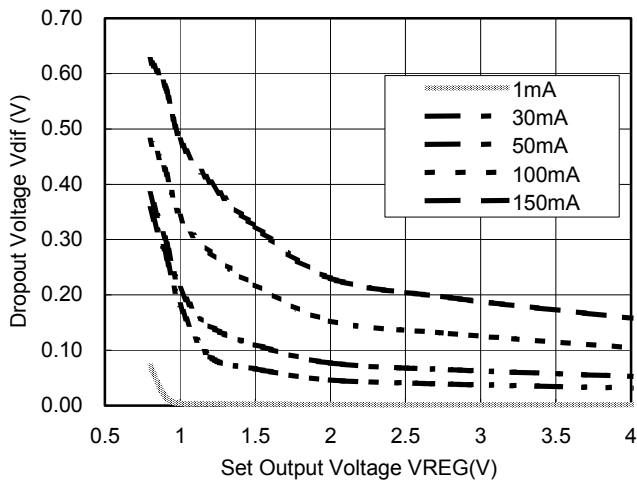

R5326X

9) Ripple Rejection vs. Input Voltage (Topt=25°C, VOUT=2.8V, Ripple 0.5Vp-p, Cin=none, Cout=Ceramic 1.0μF)
Iout=1mA

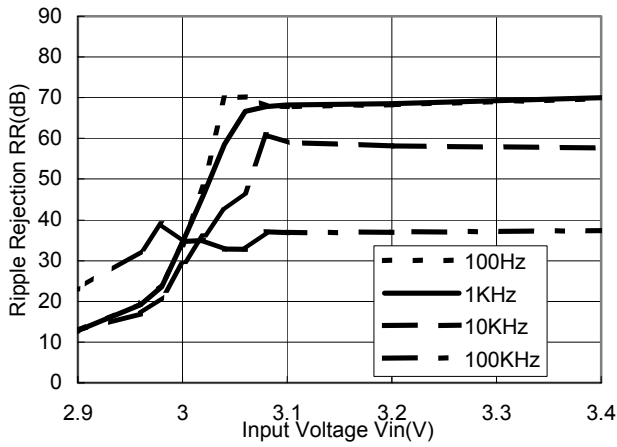

Iout=10mA

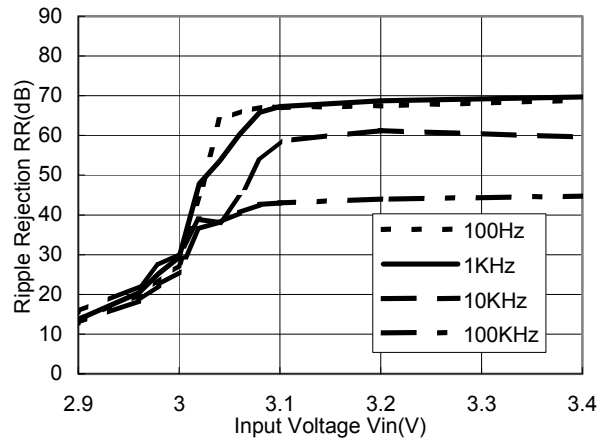

Iout=50mA

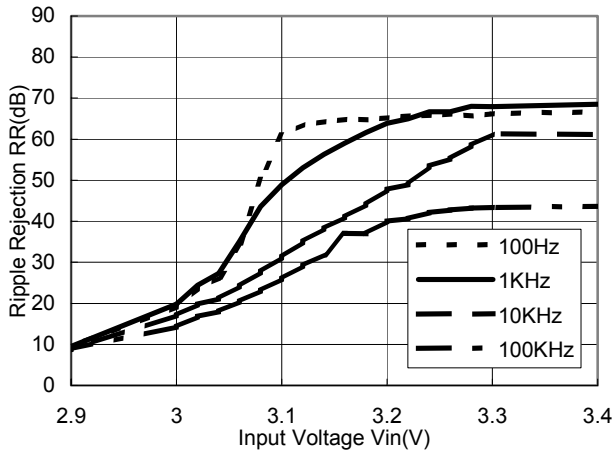

10) Minimum Operating Voltage

Vout=0.8V

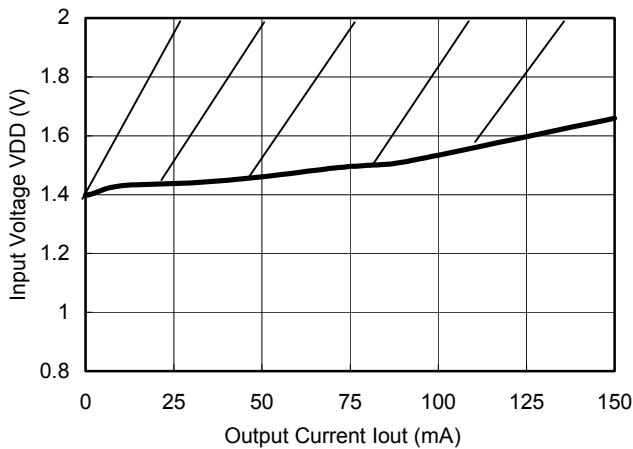

Hatched area is available for 0.8V output type.

11) Ripple Rejection vs Frequency (Cin=none)

Vout=0.8V, Vin=2.2VDC+0.5Vp-p, Cout=Ceramic 2.2μF

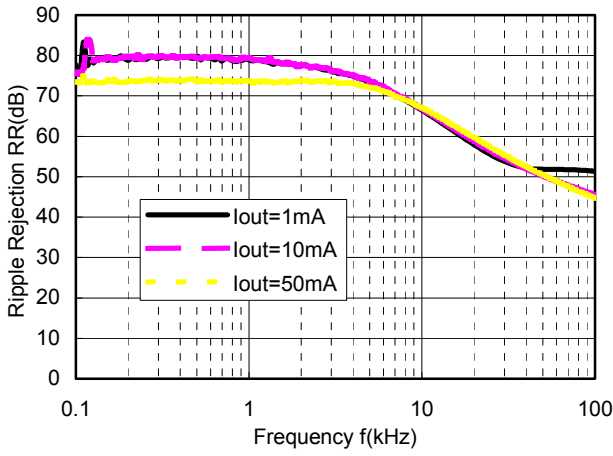

Vout=0.8V, Vin=2.2VDC+0.5Vp-p, Cout=Ceramic 3.3μF

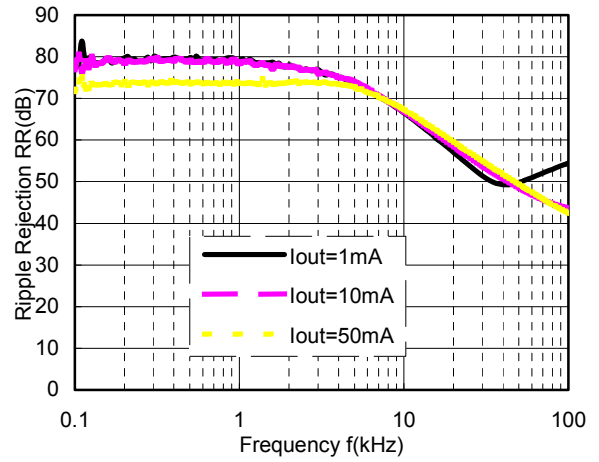

Vout=1.5V, Vin=2.5VDC+0.5Vp-p, Cout=Ceramic 1.0μF

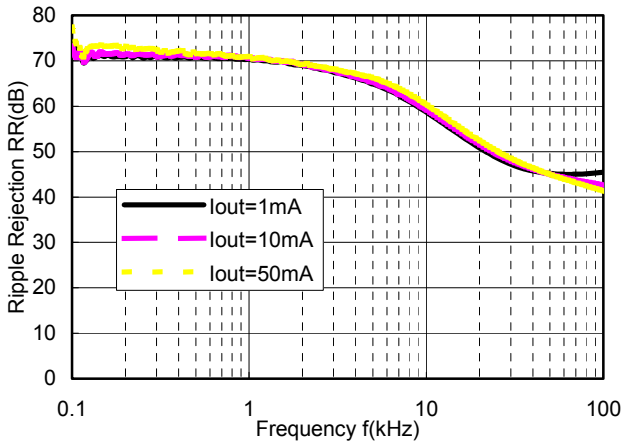

Vout=1.5V, Vin=2.5VDC+0.5Vp-p, Cout=Ceramic 2.2μF

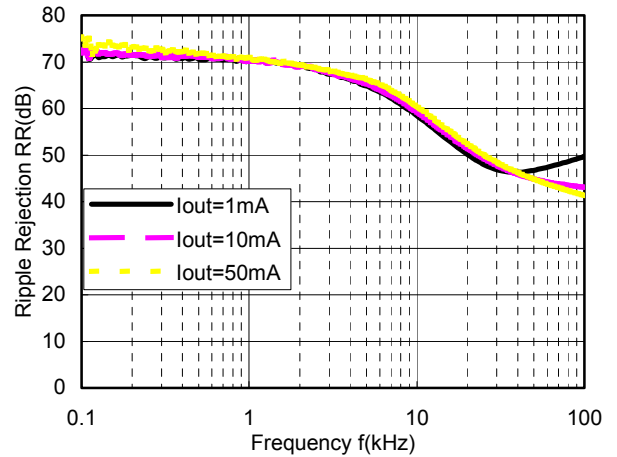

Vout=2.8V, Vin=3.8VDC+0.5Vp-p, Cout=Ceramic 1.0μF

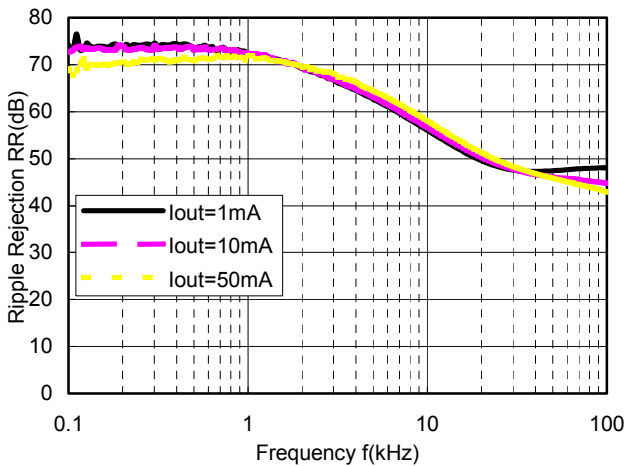

Vout=2.8V, Vin=3.8VDC+0.5Vp-p, Cout=Ceramic 2.2μF

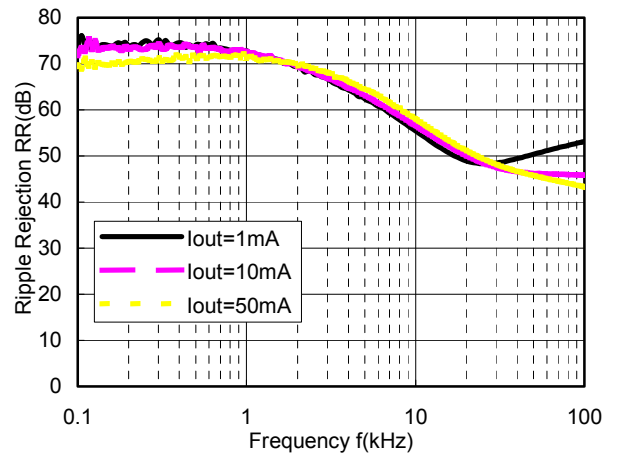

R5326X

out=4.0V, Vin=5.0VDC+0.5Vp-p, Cout=Ceramic 1.0μF

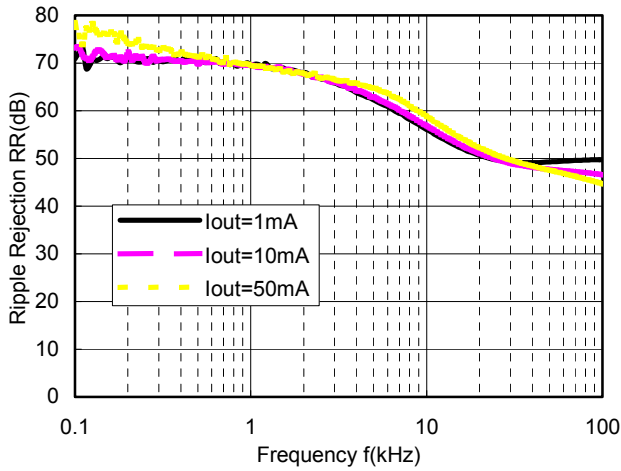

Vout=4.0V, Vin=5.0VDC+0.5Vp-p, Cout=Ceramic 2.2μF

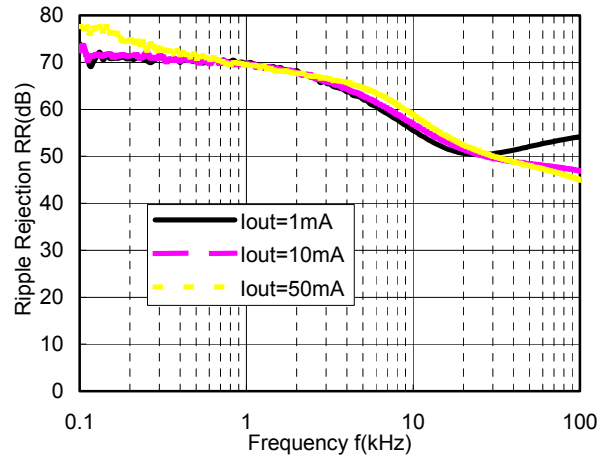

12) Input Transient Response (Iout=30mA, tr=tf=5μs, Cin=none)

Vout=0.8V, Cout=2.2μF

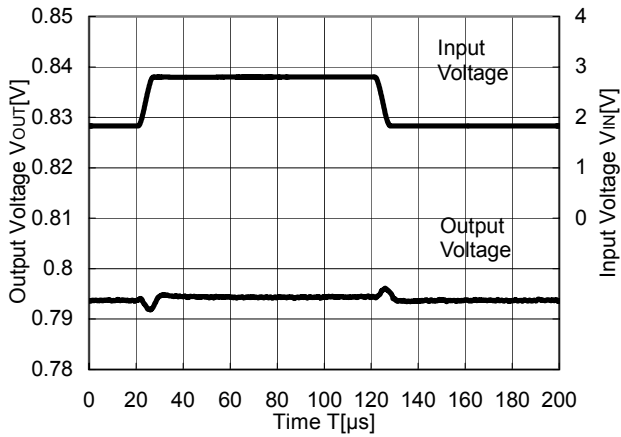

Vout=1.5V, Cout=1.0μF

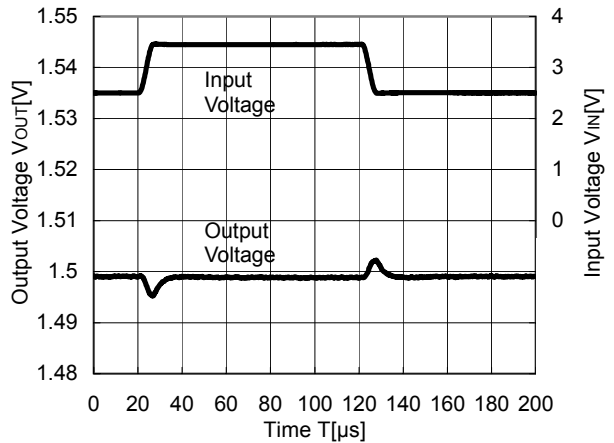

Vout=2.8V, Cout=1.0μF

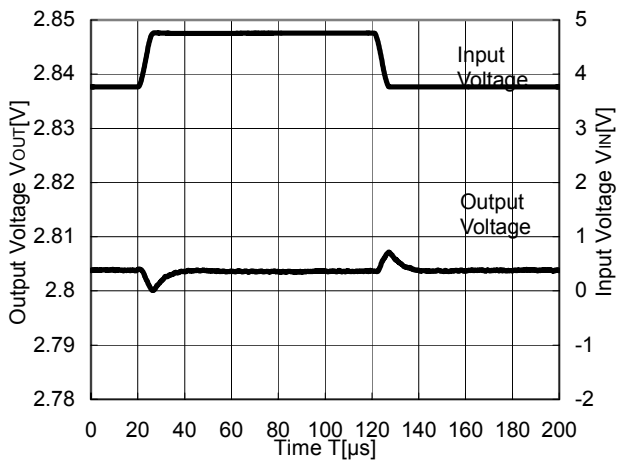

Vout=4.0V, Cout=1.0μF

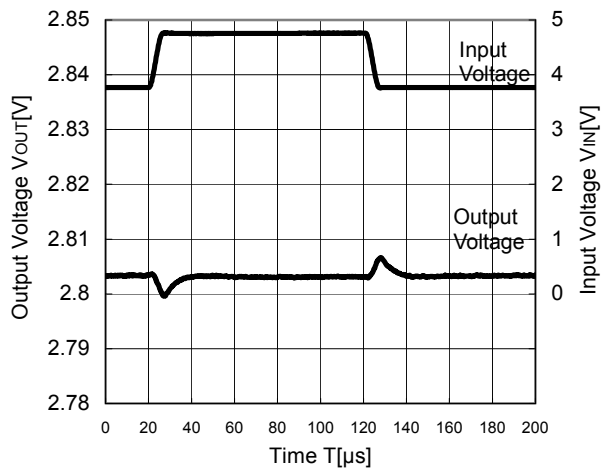

13) Load Transient Response ($T_r=T_f=0.5\mu s$, $C_{IN}=1.0\mu F$)

$V_{out}=0.8V$, $C_{OUT}=\text{Ceramic } 2.2\mu F$

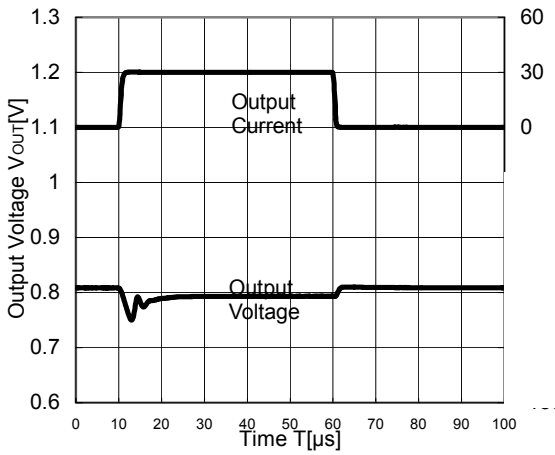

$V_{out}=0.8V$, $C_{OUT}=\text{Ceramic } 3.3\mu F$

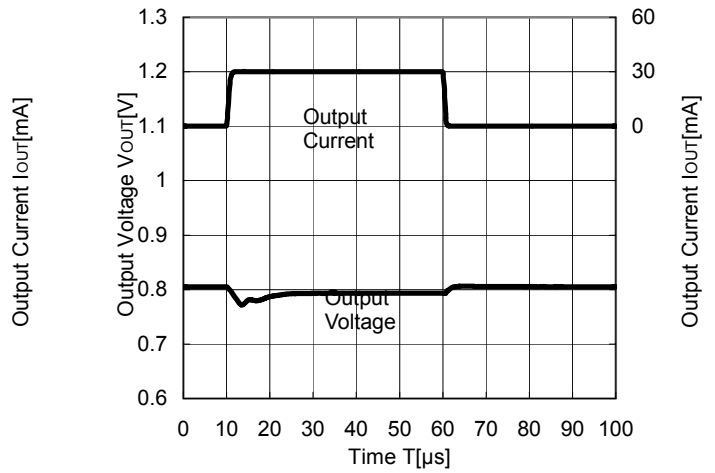

$V_{out}=1.5V$, $C_{OUT}=\text{Ceramic } 1.0\mu F$

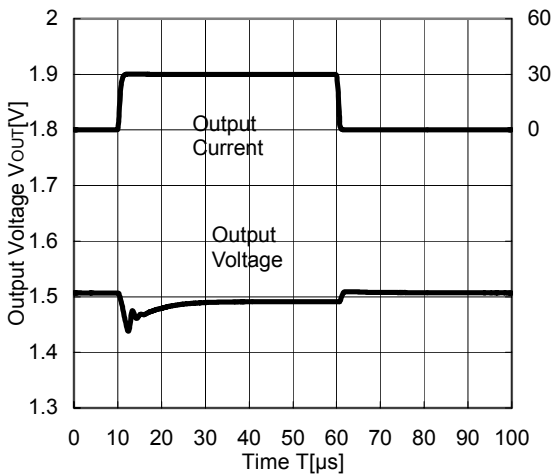

$V_{out}=1.5V$, $C_{OUT}=\text{Ceramic } 2.2\mu F$

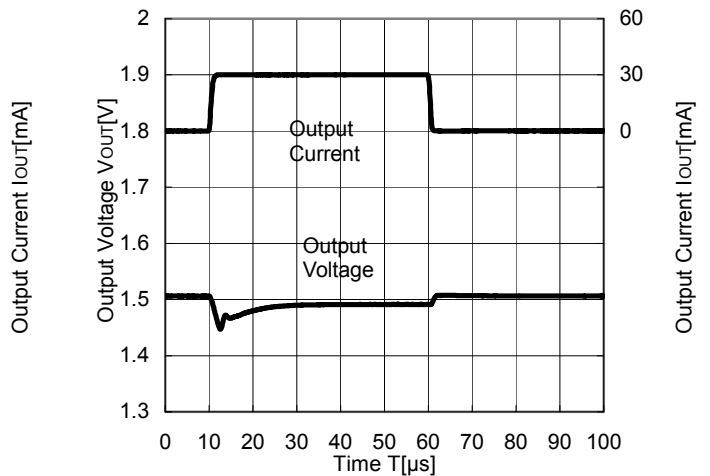

$V_{out}=2.8V$, $C_{OUT}=\text{Ceramic } 1.0\mu F$

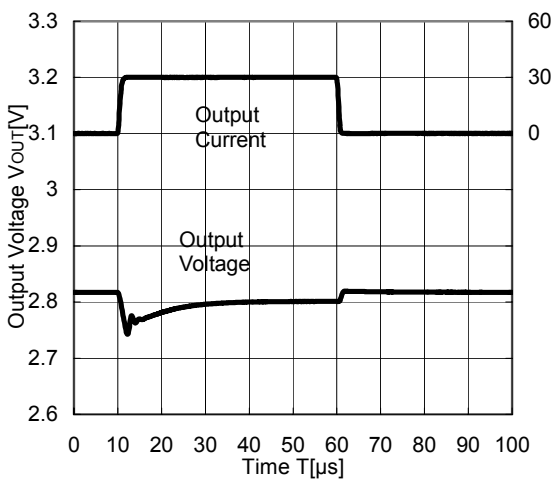

$V_{out}=2.8V$, $C_{OUT}=\text{Ceramic } 2.2\mu F$

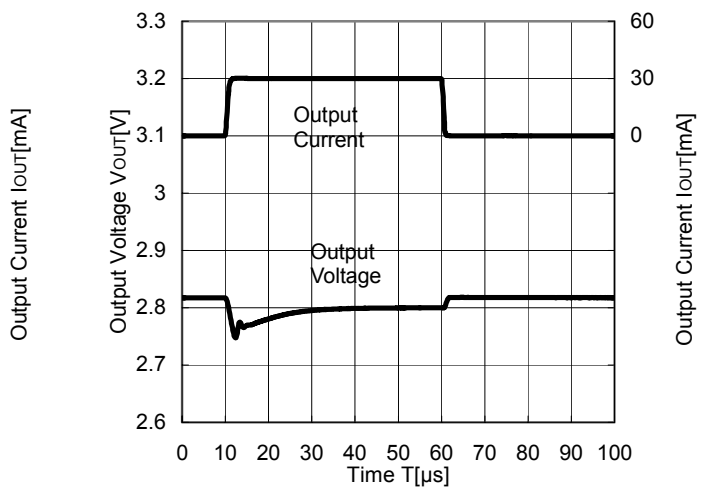

Vout=4.0V, COU=Ceramic 1.0μF

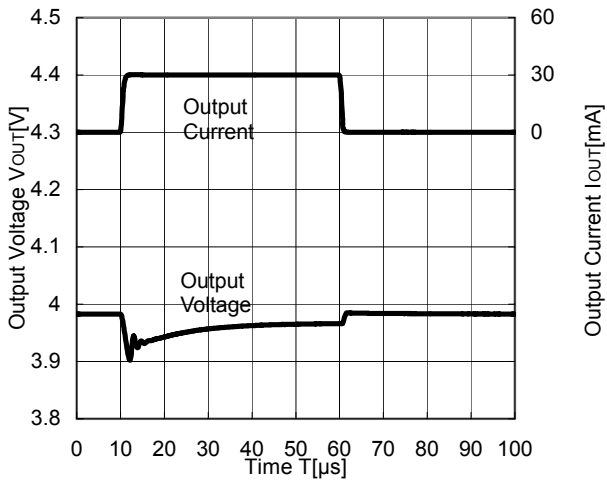

Vout=0.8V, COU=Ceramic 2.2μF

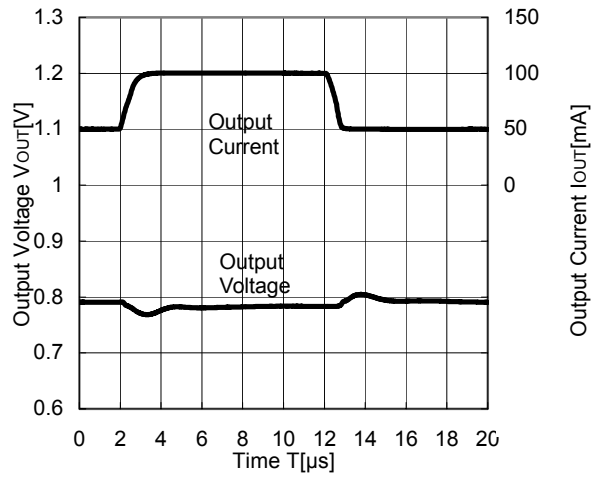

Vout=0.8V, COU=Ceramic 3.3μF

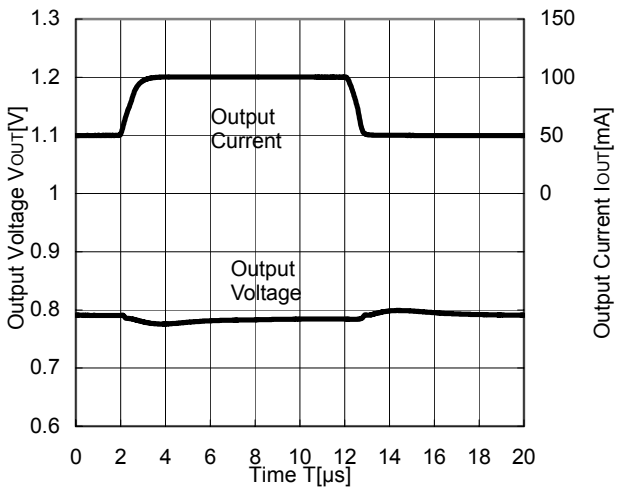

Vout=1.5V, COU=Ceramic 1.0μF

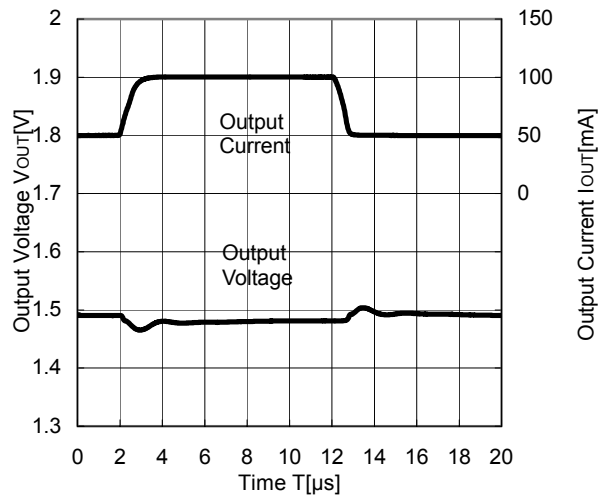

Vout=2.8V, COU=Ceramic 1.0μF

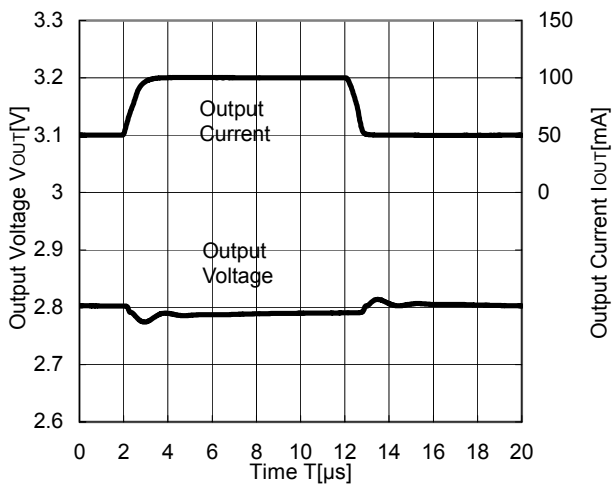

Vout=4.0V, COU=Ceramic 1.0μF

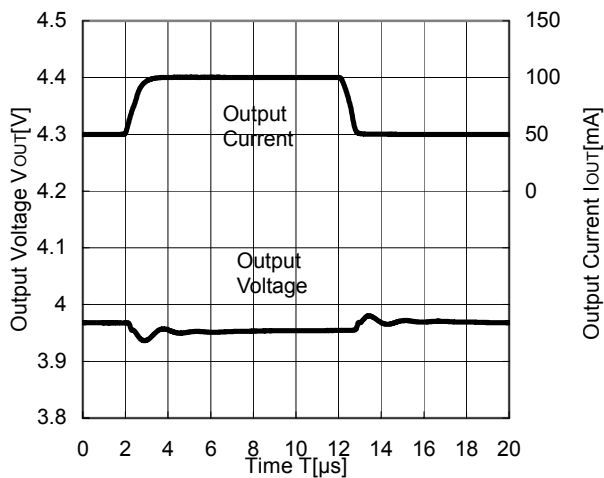

Vout=2.8V, COUT=Ceramic 1.0μF

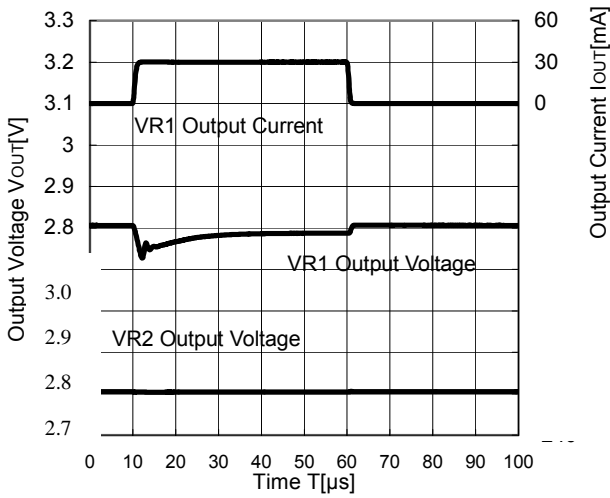

Vout=2.8V, COUT=Ceramic 1.0μF

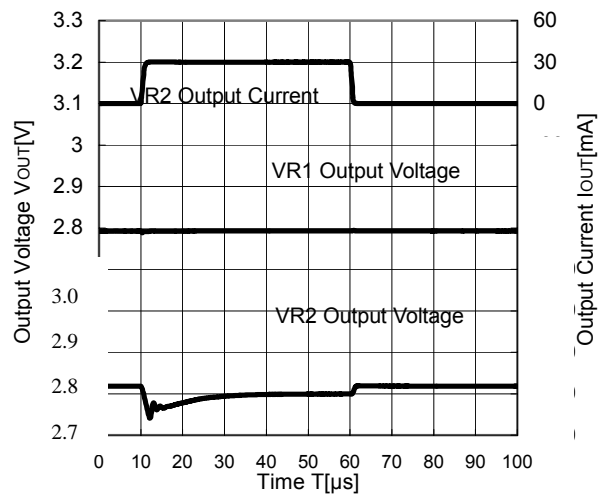

Vout=2.8V, COUT=Ceramic 1.0μF

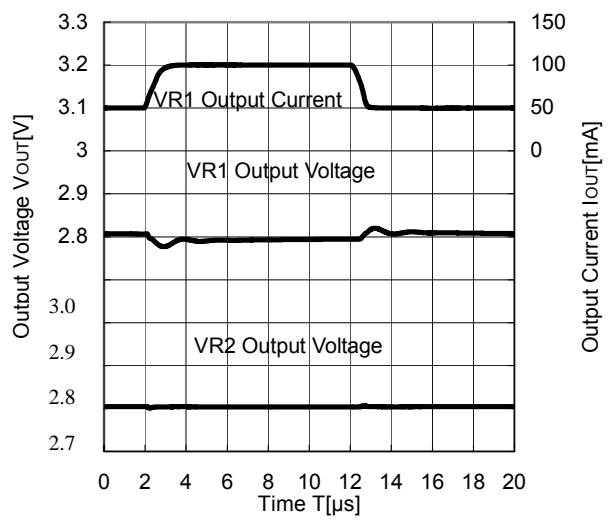

Vout=2.8V, COUT=Ceramic 1.0μF

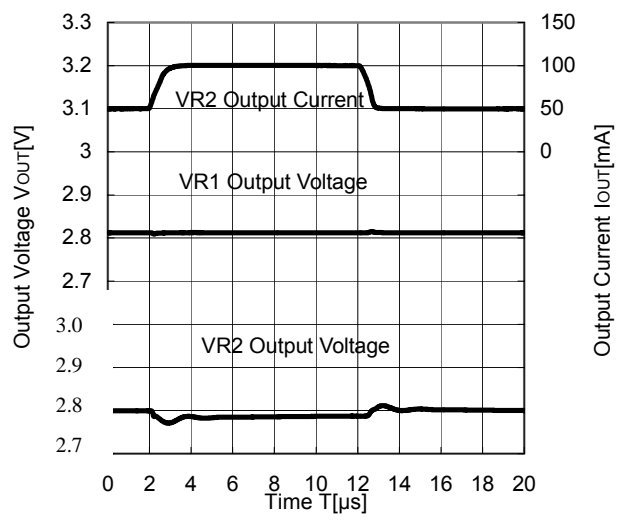

Vout=3.0V, Tr=Tf=10ns, Cout=Ceramic 1.0μF

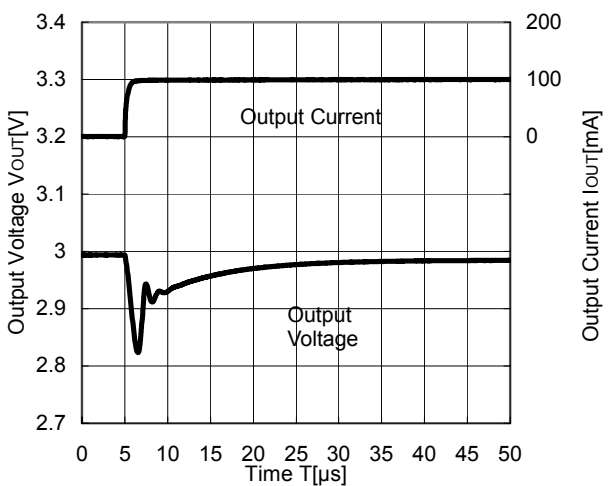

14) Turn on speed with CE signal (Cin=Ceramic 1.0μF)
 Vout=0.8V, Vin=1.8V, Cout=Ceramic 2.2μF

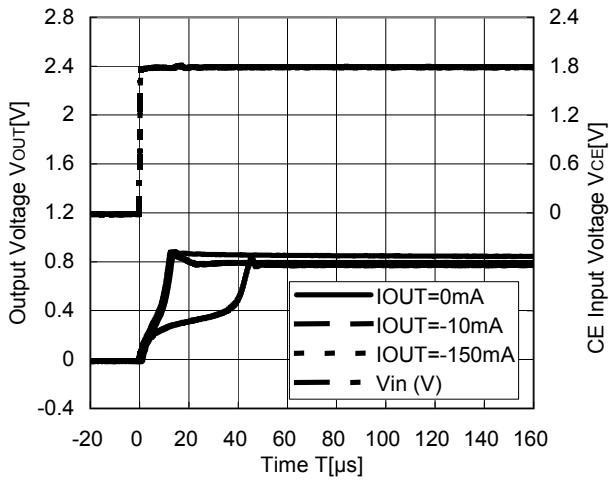

Vout=1.5V, Vin=2.5V, Cout=Ceramic 1.0μF

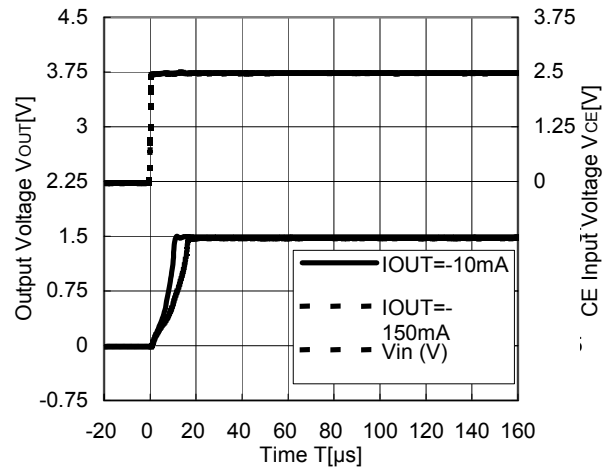

Vout=2.8V, Vin=3.8V, Cout=Ceramic 1.0μF

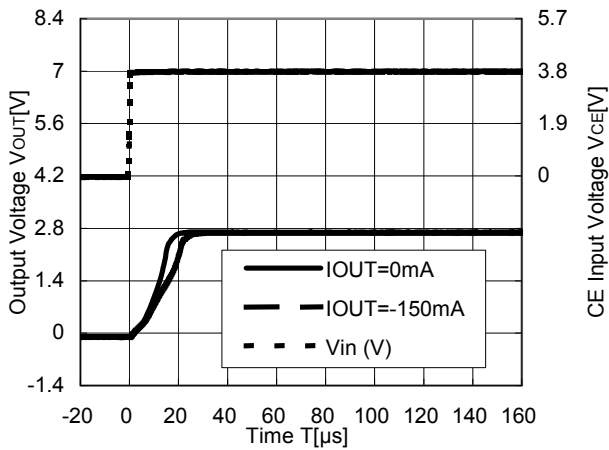

Vout=4.0V, Vin=5.0V, Cout=Ceramic 1.0μF

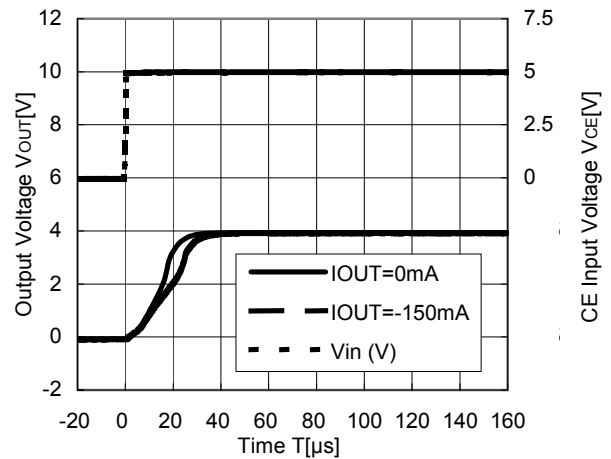

15) Turn off speed with CE signal (Cin=Ceramic 1.0μF)
 Vout=0.8V, Vin=1.8V, Cout=Ceramic 2.2μF

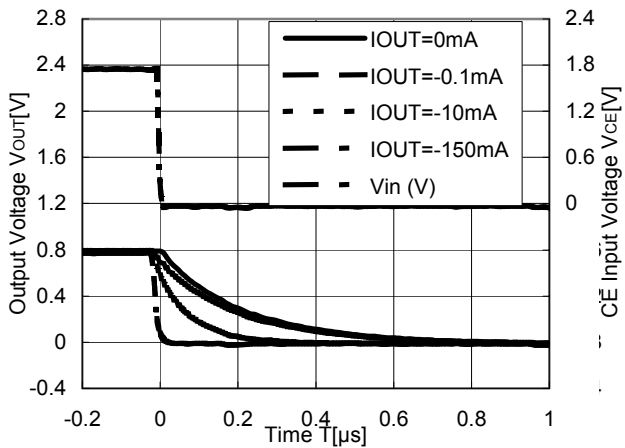

Vout=1.5V, Vin=2.5V, Cout=Ceramic 1.0μF

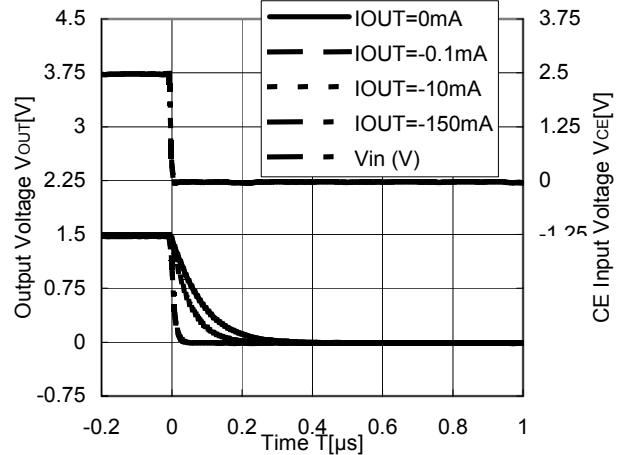

Vout=2.8V, Vin=3.8V, Cout=Ceramic 1.0μF

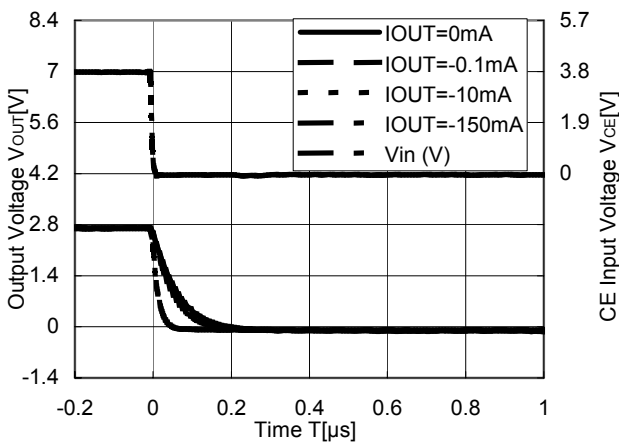

Vout=4.0V, Vin=5.0V, Cout=Ceramic 1.0μF

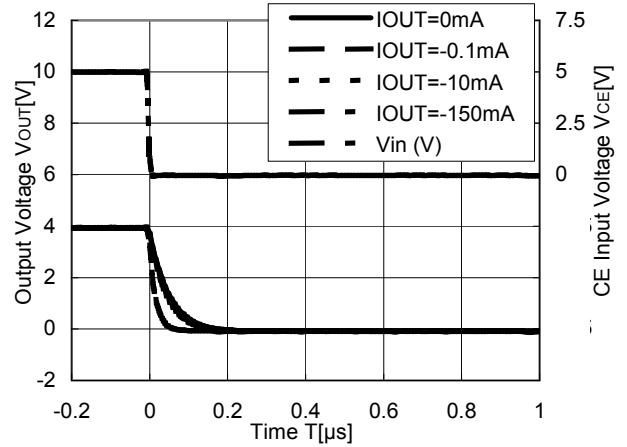

15) Acceptable Equivalent Series Resistance vs. Output Current (Inside area of the borders means the stable area. Cin=Ceramic 1.0μF)

Vout=0.8V, VIN=1.4V to 6.0V, Cout=Ceramic 1.0μF murata)

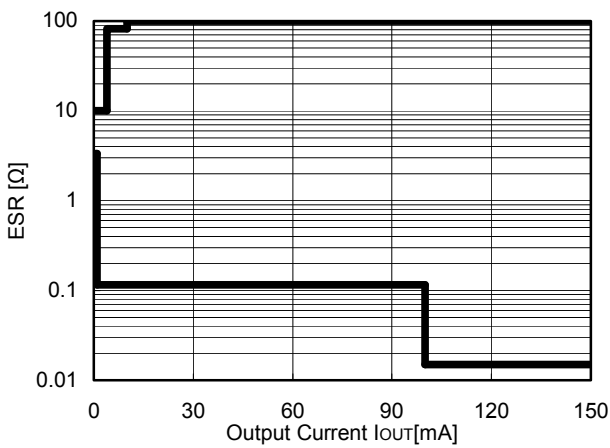

Vout=0.8V, VIN=1.55V to 6.00V, Cout=Ceramic 2.2μF murata)

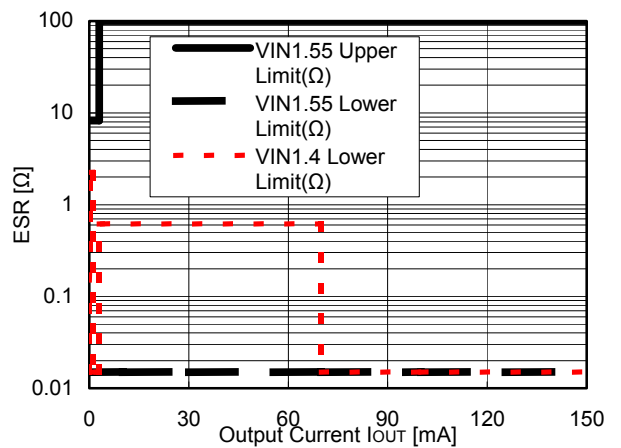

Vout=0.8V, VIN=1.4V to 6.0V, Cout=Ceramic 3.3μF murata)

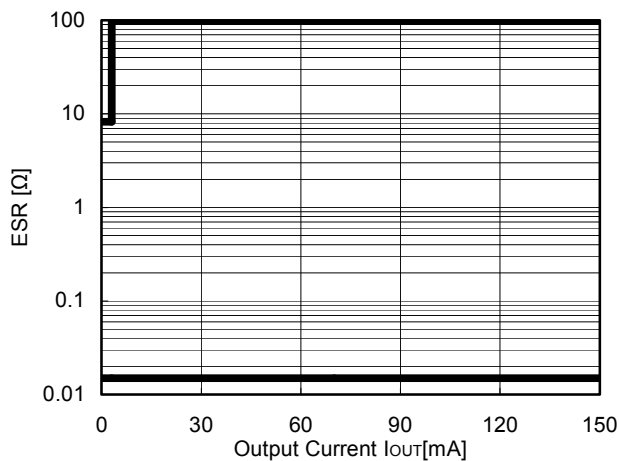

Vout=1.0V, VIN=1.4V to 6.0V, Cout=Ceramic 1.0μF murata)

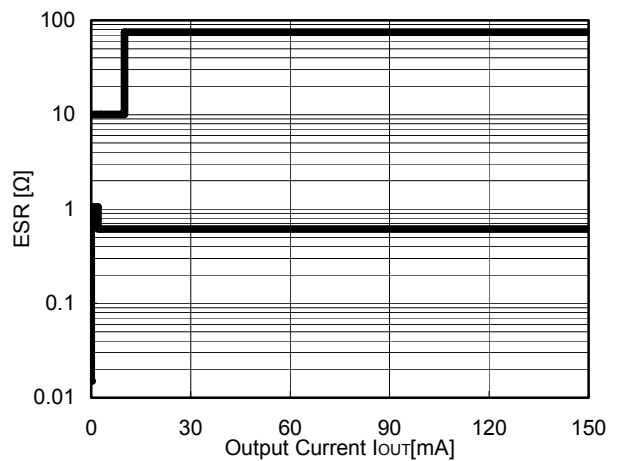

R5326X

Vout=1.0V, VIN=1.5V to 6.0V, Cout=Ceramic 2.2μF murata)

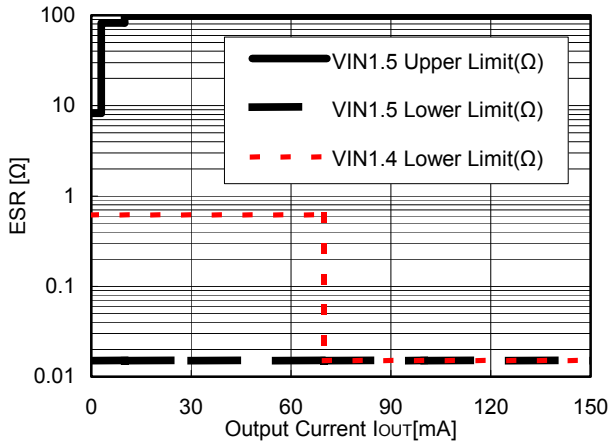

Vout=1.2V, VIN=1.65V to 6.00V, Cout=Ceramic 1.0μF murata)

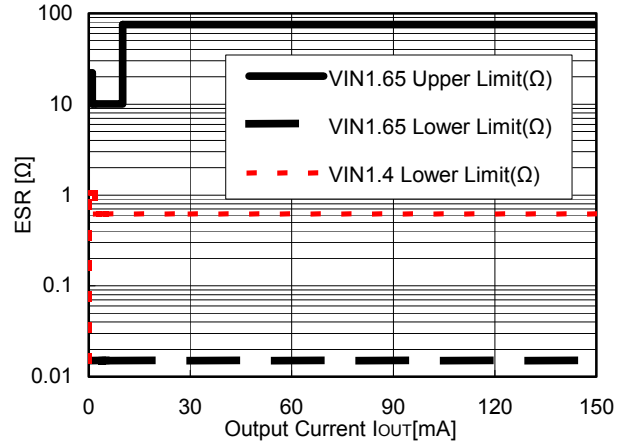

Vout=1.2V, VIN=1.5V to 6.0V, Cout=Ceramic 2.2μF murata)

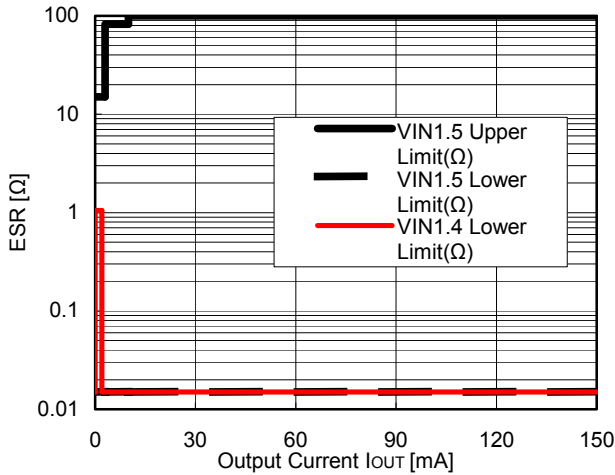

Vout=1.2V, VIN=1.4V to 6.0V, Cout=Ceramic 3.3μF murata)

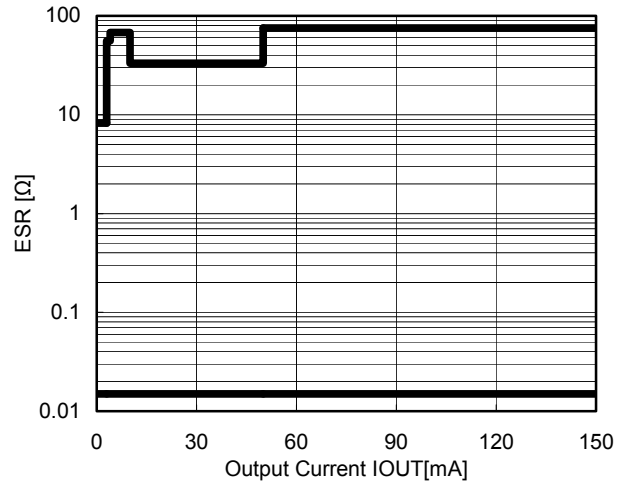

Vout=2.8V, VIN=2.8V to 6.0V, Cout=Ceramic 1.0μF murata)

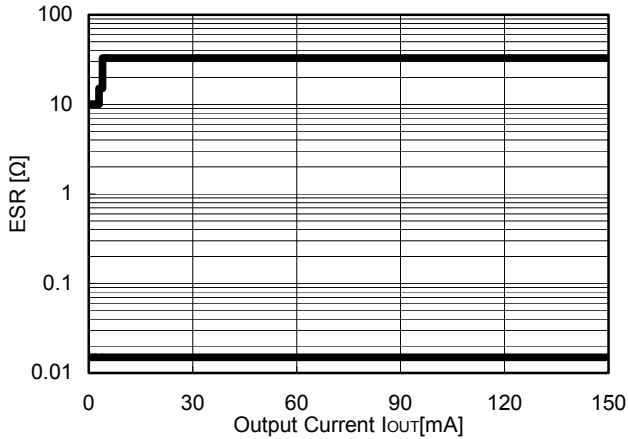

Vout=4.0V, VIN=4.0V to 6.0V, Cout=Ceramic 1.0μF murata)

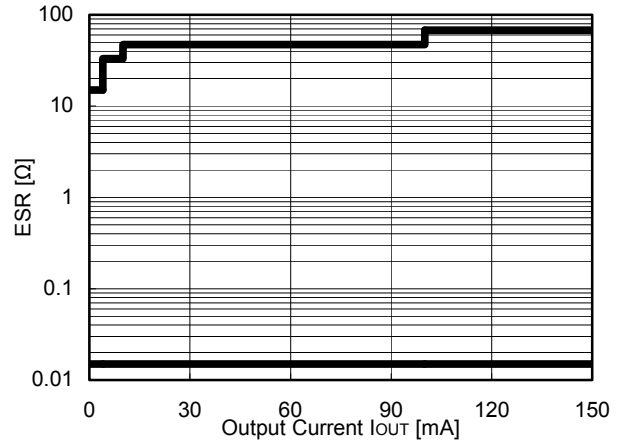

Vout=0.8V, VIN=1.5V to 6.0V, Cout=Ceramic 2.2μF
kyocera)

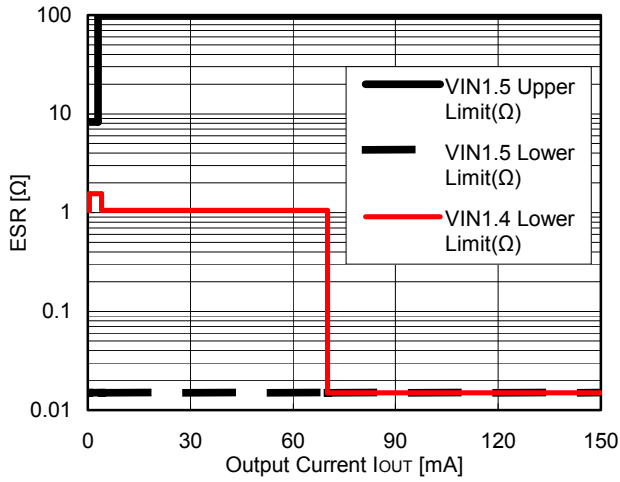

Vout=1.0V, VIN=1.5V to 6.0V, Cout=Ceramic 2.2μF
kyocera)

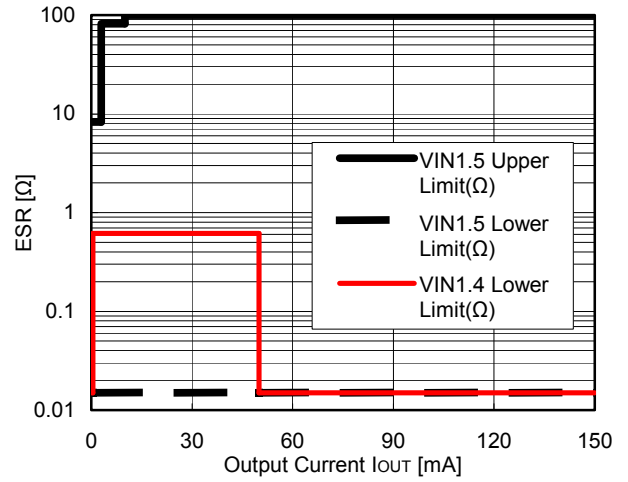

Vout=1.2V, VIN=1.45V to 6.00V, Cout=Ceramic 2.2μF
kyocera)

