

Through Hole



Size: 1 x 1 x 0.46in (25.4 x 25.4 x 11.7mm)

Chassis Mount ("C" Suffix)



Size: 2.99 x 1.24 x 0.84in (76 x 31.5 x 21.2mm)

DIN Rail Mount ("DN" Suffix)

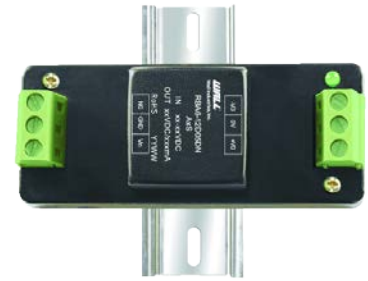

Size: 2.99 x 1.24 x 1.02in (76 x 31.5 x 25.8mm)

**OPTIONS**

- Package Type
  - Through Hole
  - Chassis Mount
  - DIN Rail Mount

**FEATURES**

- Wide 2:1 Input Voltage Range
- High Efficiency
- Isolated & Regulated Dual and Single Output Models
- Isolation Voltage of 1500VDC
- International Standard Pin-Out
- RoHS Compliant
- 3 Years Warranty
- Input Under Voltage Protection
- Output Over Voltage, Over Current, and Short Circuit Protection
- Reverse Voltage Protection Available for Chassis & DIN Rail Mounting
- Meets CISPR32/EN55032 Class A without External Components
- IEC60950, UL60950, and EN60950 Approval

**APPLICATIONS**

- Industrial Robotics

**DESCRIPTION**

The RBA6 series of DC/DC converters offers 6 watts of output power in a through hole, chassis mount, or DIN Rail mount package. This series consists of isolated and regulated dual and single output models with a wide 2:1 input voltage range. Features of this series include high efficiency, isolation voltage of 1500VDC, and protection against input under voltage and output over voltage, over current, and short circuit conditions. This series has IEC60950, UL60950, and EN60950 approvals and is RoHS compliant.

**MODEL SELECTION TABLE**

Single Output Models

Model Number <sup>(1)</sup>	Input Voltage Range	Output Voltage	Output Current		Efficiency <sup>(2)</sup>		Maximum Capacitive Load <sup>(3)</sup>	Certification	Ripple & Noise	Output Power
			Min Load	Max Load	Min.	Typ.				
RBA6-12S05	12VDC (9~18VDC)	5VDC	0mA	1200mA	79%	81%	1000µF	CE	60mVp-p	6W
RBA6-12S12		12VDC	0mA	500mA	83%	85%	470µF	CE		
RBA6-24S03	24VDC (18~36VDC)	3.3VDC	0mA	1500mA	75%	77%	1800µF	CE	60mVp-p	6W
RBA6-24S05		5VDC	0mA	1200mA	80%	82%	1000µF	CE		
RBA6-24S09		9VDC	0mA	667mA	83%	85%	470µF	-		
RBA6-24S12		12VDC	0mA	500mA	83%	85%	470µF	CE		
RBA6-24S15		15VDC	0mA	400mA	84%	86%	220µF	CE		
RBA6-24S24		24VDC	0mA	250mA	83%	85%	100µF	CE		
RBA6-48S03	48VDC (36~75VDC)	3.3VDC	0mA	1500mA	77%	79%	1800µF	-	60mVp-p	6W
RBA6-48S05		5VDC	0mA	1200mA	81%	83%	100µF	-		
RBA6-48S12		12VDC	0mA	500mA	85%	87%	470µF	-		
RBA6-48S15		15VDC	0mA	400mA	86%	88%	220µF	-		
RBA6-48S24		24VDC	0mA	250mA	86%	88%	100µF	-		

**MODEL SELECTION TABLE**

Dual Output Models

Model Number <sup>(1)</sup>	Input Voltage Range	Output Voltage	Output Current		Efficiency <sup>(2)</sup>		Maximum Capacitive Load <sup>(3)</sup>	Certification	Ripple & Noise	Output Power
			Min Load	Max Load	Min.	Typ.				
RBA6-12D05	12VDC (9~18VDC)	±5VDC	0mA	±600mA	79%	81%	470µF	UL/CE/CB	60mVp-p	6W
RBA6-12D12		±12VDC	0mA	±250mA	83%	85%	100µF	UL/CE/CB		
RBA6-24D05	24VDC (18~36VDC)	±5VDC	0mA	±600mA	81%	83%	470µF	UL/CE/CB	60mVp-p	6W
RBA6-24D12		±12VDC	0mA	±250mA	85%	87%	100µF	UL/CE/CB		
RBA6-24D15		±15VDC	0mA	±200mA	85%	87%	100µF	UL/CE/CB		

**SPECIFICATIONS**

All specifications are based on 25°C, Humidity <75%RH, Nominal Input Voltage, and Rated Output Load unless otherwise noted. We reserve the right to change specifications based on technological advances.

SPECIFICATION	TEST CONDITIONS		Min	Typ	Max	Unit	
<b>INPUT SPECIFICATIONS</b>							
Input Voltage Range <sup>(4)</sup>	12VDC Nominal Input		9	12	18	VDC	
	24VDC Nominal Input		18	24	36		
	48VDC Nominal Input		36	48	75		
Maximum Input Voltage <sup>(5)</sup>	12VDC Nominal Input				20	VDC	
	24VDC Nominal Input				40		
	48VDC Nominal Input				80		
Full Load Input Current	12VDC Nominal Input	3.3VDC Output		603	633	mA	
		Other Models		268	275		
	24VDC Nominal Input	3.3VDC Output		296	313		
		Other Models		130	134		
No Load Input Current	12VDC Nominal Input	3.3VDC Output		10	22	mA	
		Other Models		5	15		
	24VDC Nominal Input	3.3VDC Output		5	15		
		Other Models		4	8		
48VDC Nominal Input	3.3VDC Output		4	8			
	Other Models		4	8			
Reflected Ripple Current				20		mA	
Surge Voltage (1 sec. max.)	12VDC Nominal Input		-0.7		25	VDC	
	24VDC Nominal Input		-0.7		50		
	48VDC Nominal Input		-0.7		100		
Starting Voltage	12VDC Nominal Input				9	VDC	
	24VDC Nominal Input				18		
	48VDC Nominal Input				36		
Input Under-Voltage Protection	12VDC Nominal Input		5.5	6.5		VDC	
	24VDC Nominal Input		12	15.5			
	48VDC Nominal Input		26	30			
Input Filter			Pi Filter				
Hot Plug			Unavailable				
<b>OUTPUT SPECIFICATIONS</b>							
Output Voltage			See Table				
Voltage Accuracy	5%-100% Load			±1	±3	%	
	0%-5% Load		±5VDC Output	±2	±5		
Line Regulation <sup>(6)</sup>	Full Load, Input voltage from low to high voltage		Others	±1	±3	%	
			Positive Output	±0.2	±0.5		
Load Regulation	5%-100% Load		Negative Output	±0.5	±1	%	
			Positive Output	±0.5	±1		
Cross Regulation	Dual Outputs, main circuit with 50% load, auxiliary circuit with 10%-100% load		Negative Output	±0.5	±1.5	%	
Output Power			See Table				
Output Current			See Table				
Maximum Capacitive Load	Tested at input voltage range and full load		See Table				
Ripple & Noise <sup>(7)</sup>	20MHz bandwidth, 5%-100% Load			60	85	mVp-p	
Transient Recovery Time	25% Load Step Change			300	500	µs	
Transient Response Deviation	25% Load Step Change		3.3VDC, 5VDC, & ±5VDC Outputs		±5	±8	%
			Other Models		±3	±5	
Temperature Coefficient	Full Load				±0.03	%/°C	
No Load Power Consumption			0.12			W	
<b>PROTECTION</b>							
Short Circuit Protection	Input Voltage Range		Continuous, Self-Recovery				
Over Current Protection	Input Voltage Range		110		160	%Vo	
Over Voltage Protection	Input Voltage Range		110	140	190	%Io	
<b>ENVIRONMENTAL SPECIFICATIONS</b>							
Operating Temperature			-40		+85	°C	
Storage Temperature			-55		+125	°C	
Lead Temperature	Welding spot is 1.5mm away from the casing, 10 seconds				+300	°C	
Storage Humidity	Without Condensation		5		95	%RH	
Vibration			10-55Hz, 10G, 30 Min. along X, Y, and Z				
MTBF	MIL-HDBK-217F @25°C		1000			KHours	

**SPECIFICATIONS**

All specifications are based on 25°C, Humidity <75%RH, Nominal Input Voltage, and Rated Output Load unless otherwise noted.  
We reserve the right to change specifications based on technological advances.

SPECIFICATION	TEST CONDITIONS		Min	Typ	Max	Unit
<b>GENERAL SPECIFICATIONS</b>						
Efficiency			See Table			
Switching Frequency <sup>(8)</sup>	PWM Mode			300		kHz
Insulation Voltage	Input-Output, with test time of 1 minutes & leak current lower than 1mA		1500			VDC
Insulation Resistance	Input-Output, insulation voltage 500VDC		1000			MΩ
Isolation Capacitance	Input-Output, 100KHz/0.1V			1000		pF
<b>PHYSICAL SPECIFICATIONS</b>						
Weight	Through Hole		0.49oz (14g)			
	Chassis Mount		1.27oz (36g)			
	DIN Rail Mount		1.98oz (56g)			
Dimensions (L x W x H)	Through Hole		1in x 1in x 0.46in (25.4mm x 25.4mm x 11.7mm)			
	Chassis Mount		2.99in x 1.24in x 0.84in (76mm x 31.5mm x 21.2mm)			
	DIN Rail Mount		2.99in x 1.24in x 1.02in (76mm x 31.5mm x 25.8mm)			
Casing Material			Aluminum Alloy			
Cooling Method			Free Air Convection			
<b>SAFETY CHARACTERISTICS</b>						
Safety Approvals			IEC60950, UL60950, EN60950			
EMI	CE	12VDC & 24VDC Nominal Input	CISPR32/EN55032		Class A (without external components) Class B <sup>(9)</sup>	
		48VDC Nominal Input	CISPR32/EN55032		Class B <sup>(9)</sup>	
	RE	12VDC & 24VDC Nominal Input	CISPR32/EN55032		Class A (without external components) Class B <sup>(9)</sup>	
		48VDC Nominal Input	CISPR32/EN55032		Class B <sup>(9)</sup>	
EMS	EMS	IEC/EN61000-4-2	Contact ±4kV	Perf. Criteria B		
	RS	IEC/EN61000-4-3	10V/m	Perf. Criteria A		
	EFT	IEC/EN61000-4-4	±2kV <sup>(9)</sup>	Perf. Criteria B		
	Surge	IEC/EN61000-4-5	Line to Line ±2kV <sup>(9)</sup>	Perf. Criteria B		
	CS	IEC/EN61000-4-6	3 Vr.m.s	Perf. Criteria A		
	Voltage Dips, Short Interruptions & Voltage Variations Immunity	IEC/EN61000-4-29	0%, 70%	Perf. Criteria B		

**NOTES**

- Chassis mount and DIN rail mount options are available for this series. To indicate Chassis Mount, add "C" suffix to model number Ex. RBA6-12S05C. To indicate DIN rail mount options, add "DN" suffix to model number Ex. RBA6-12S05DN.
- Efficiency is measured in nominal input voltage and rated output load. Due to input reverse polarity, chassis and DIN rail mount models minimum efficiency greater than Min-2 is qualified.
- Capacitive load of positive and negative outputs are identical
- Due to input reverse polarity protection function, minimum value and input voltage range and starting voltage is higher than 1VDC DIP package.
- This is the absolute maximum rating the converter can operate at without damage, but it is not recommended.
- When testing from 0%-100% load working conditions, load regulation index is ±5%
- 0%-5% load ripple & Noise is no more than 5% Vo. Ripple and noise are measured by "parallel cable" method.
- This series of products uses reduced frequency technology. The switching frequency is test value of full load, when load is reduced to below 50%, switching frequency decreases with decreasing load.
- See Design Reference for recommended circuit.
- Recommended unbalanced degree of the dual output module load is ≤±5%. If the degree exceeds ±5%, then the product performance cannot be guaranteed to comply with all parameters in the datasheet. Please contact factory for more information.
- Customization is available, please contact factory.

\*Due to advances in technology, specifications subject to change without notice.

TEMPERATURE DERATING CURVE

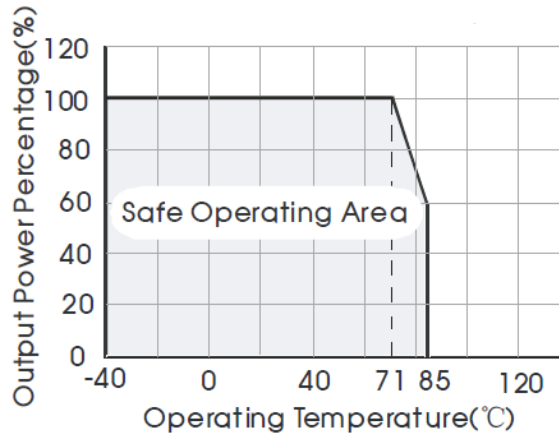

EFFICIENCY GRAPHS

Efficiency vs. Input Voltage (Full Load) RBA6-24D15

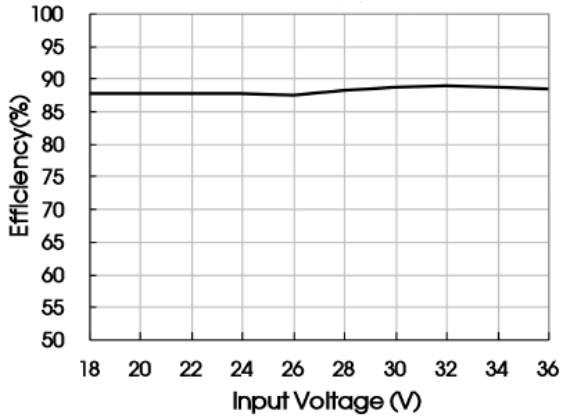

Efficiency vs. Output Load (Vin=24V) RBA6-24D15

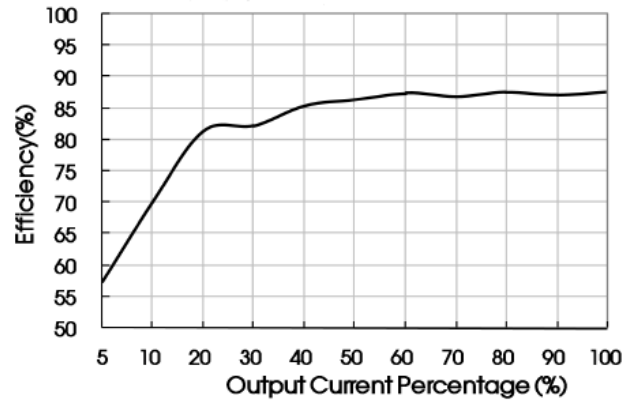

Efficiency vs. Input Voltage (Full Load) RBA6-24S05

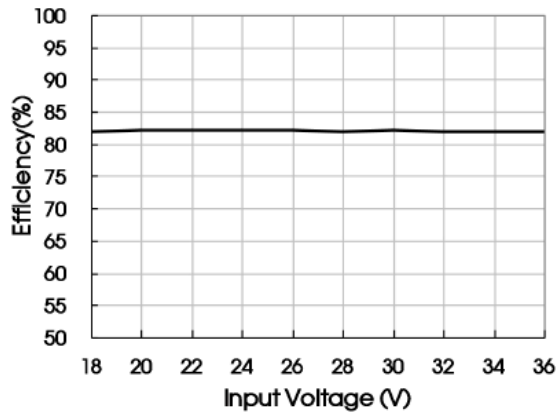

Efficiency vs. Output Load (Vin=24V) RBA6-24S05

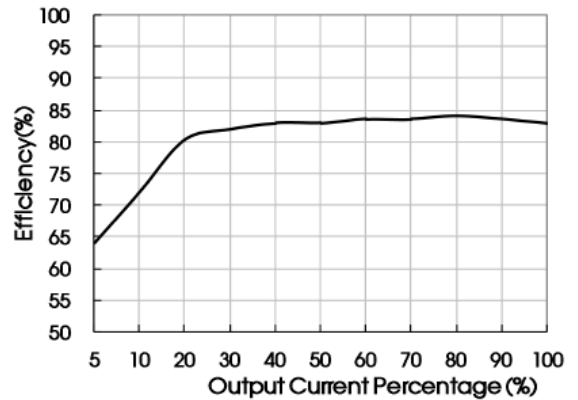

MECHANICAL DRAWINGS

Through Hole

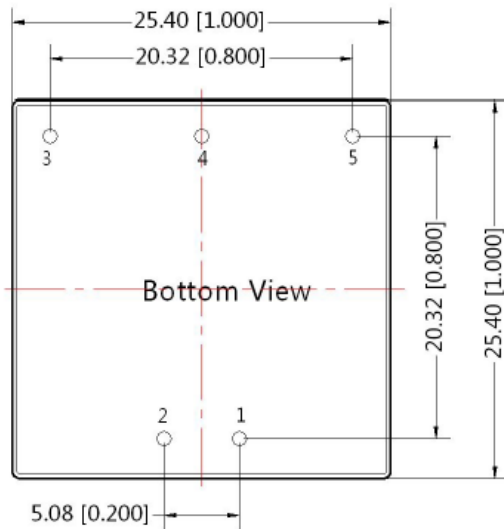
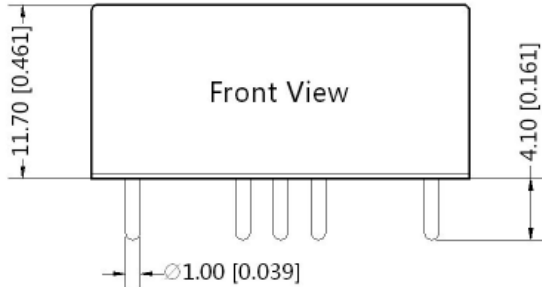

THIRD ANGLE PROJECTION

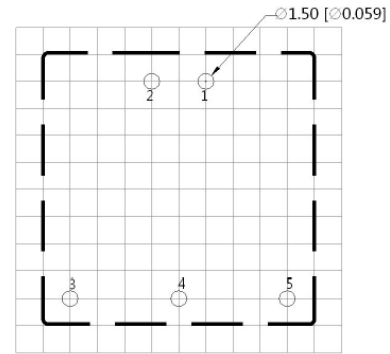

Note: Grid 2.54\*2.54mm

Pin Out

Pin	Single	Dual
1	GND	GND
2	Vin	Vin
3	+Vo	+Vo
4	No Pin	0V
5	0V	-Vo

Note:  
Unit: mm [inch]  
Pin diameter tolerances:  $\pm 0.10$  [ $\pm 0.004$ ]  
General Tolerances:  $\pm 0.50$  [ $\pm 0.020$ ]

Chassis Mount ("C" Suffix)

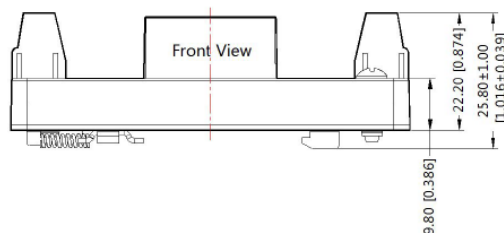
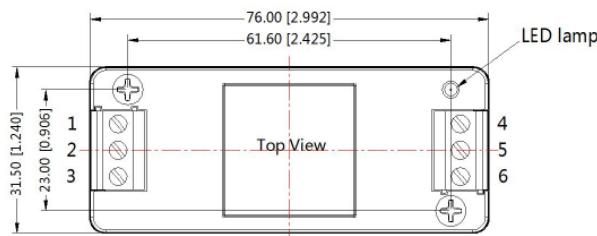

THIRD ANGLE PROJECTION

Pin Out

Pin	1	2	3	4	5	6
Dual	NC	GND	Vin	-Vo	0V	+Vo
Single	NC	GND	Vin	0V	NC	+Vo

Note:  
Unit: mm [inch]  
Mounting rail: TS35  
Wire range: 24-12 AWG  
Tightening torque: Max 0.4 N·m  
General tolerances:  $\pm 1.00$  [ $\pm 0.039$ ]

DIN Rail Mount ("DN" Suffix)

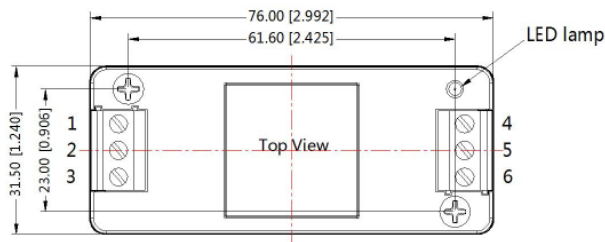

THIRD ANGLE PROJECTION

Pin Out

Pin	1	2	3	4	5	6
Dual	NC	GND	Vin	-Vo	0V	+Vo
Single	NC	GND	Vin	0V	NC	+Vo

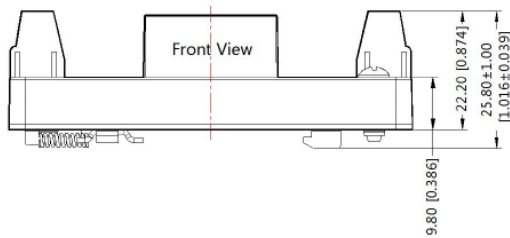

Note:  
Unit: mm [inch]  
Mounting Rail: TS35  
Wire Range: 24-12 AWG  
Tightening Torque: Max 0.4 N·m  
General tolerances: ±1.00 [±0.039]

DESIGN REFERENCE

1. Typical Application Circuit

All the DC/DC converters in this series are tested according to the recommended circuit (below) before delivery. If it is required to further reduce input and output ripple, properly increase the input & output of additional capacitors Cin and Cout or select capacitors of low equivalent impedance provided that the capacitance is no larger than the max. capacitive load of the product.

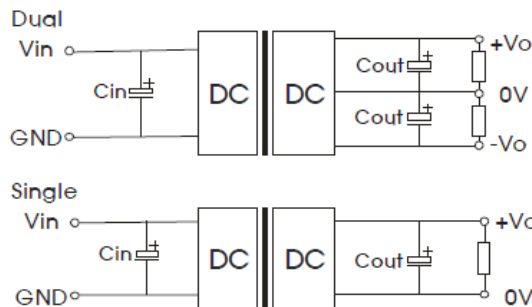

Vin (VDC)	Cin(μF)	Cout(μF)
12	100	10
24	10-47	
48	100	

2. EMC Solution-Recommended Circuit

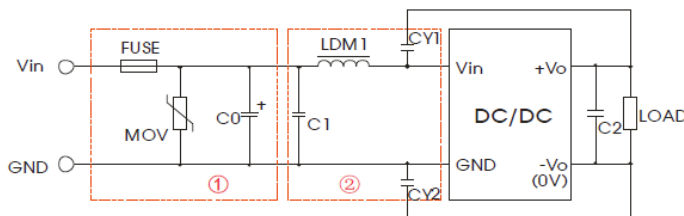

Notes: Part ① in the above figure is used for EMS test and part ② for EMI filtering; selected based on needs.

Parameter Description

Model	Vin: 12V	Vin: 24V	Vin: 48V
FUSE	Choose according to actual input current		
MOV	S14K20	S20K30	14D101K
C0	1000μF/35V	1000μF/50V	330uF/100V
C1	1μF/50V		4.7uF/100V
C2	Refer to the Cout in Typ. Application Circuit		
LDM1	4.7μH		
CY1/CY2	1nF/2KV		

3. It is not allowed to connect modules output in parallel to increase power.

MODEL NUMBER SETUP

RBA	6	-	12	S	05	C
Series Name	Output Power		Input Voltage	Output Quantity	Ouput Voltage	Mount Options
			<b>12:</b> 9~18VDC <b>24:</b> 18~36VDC <b>48:</b> 36~75VDC	<b>S:</b> Single  <b>D:</b> Dual	<b>3.3:</b> 3.3VDC <b>5:</b> 5VDC <b>9:</b> 9VDC <b>12:</b> 12VDC <b>15:</b> 15VDC <b>24:</b> 24VDC  <b>5:</b> ±5VDC <b>12:</b> ±12VDC <b>15:</b> ±15VDC	<b>None:</b> Through Hole <b>C:</b> Chassis Mount <b>DN:</b> DIN Rail

COMPANY INFORMATION

Wall Industries, Inc. has created custom and modified units for over 50 years. Our in-house research and development engineers will provide a solution that exceeds your performance requirements on-time and on budget. Our ISO9001-2008 certification is just one example of our commitment to producing a high quality, well-documented product for our customers.

Our past projects demonstrate our commitment to you, our customer. Wall Industries, Inc. has a reputation for working closely with its customers to ensure each solution meets or exceeds form, fit and function requirements. We will continue to provide ongoing support for your project above and beyond the design and production phases. Give us a call today to discuss your future projects.

Contact **Wall Industries** for further information:

Phone: ☎(603)778-2300  
 Toll Free: ☎(888)597-9255  
 Fax: ☎(603)778-9797  
 E-mail: [sales@wallindustries.com](mailto:sales@wallindustries.com)  
 Web: [www.wallindustries.com](http://www.wallindustries.com)  
 Address: 37 Industrial Drive  
 Exeter, NH 03833