

ECONOLINE - DC/DC-Converter

RD and RC Series, 2 Watt, SIP7/DIP14 (Dual Output)

RECOM

Features

- Dual Output from a Single Input Rail
- Power Sharing on Output
- 1kVDC & 2kVDC Isolation
- Custom Solutions Available
- UL94V-0 Package Material
- Efficiency to 80%

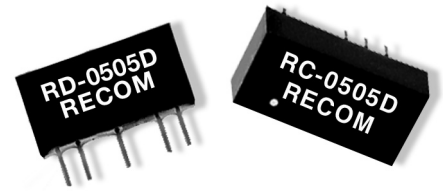

Selection Guide

Part Number SIP7	Part Number DIP14	2kV	Input Voltage (VDC)	Output Voltage (VDC)	Output Current (mA)	Efficiency (%)
RD-XX3.3D	RC-XX05D	(H)	5, 9, 12, 15, 24	±3.3	±303	70
RD-XX05D	RC-XX05D	(H)	5, 9, 12, 15, 24	±5	±200	70-75
RD-XX09D	RC-XX09D	(H)	5, 9, 12, 15, 24	±9	±111	75-81
RD-XX12D	RC-XX12D	(H)	5, 9, 12, 15, 24	±12	±84	78-83
RD-XX15D	RC-XX15D	(H)	5, 9, 12, 15, 24	±15	±66	80-84
RD-XX24D	RC-XX05D	(H)	5, 9, 12, 15, 24	±24	±42	80-85

Specifications (Core Operating Area) and Operating Temperature / Derating-Graph

Input Voltage	±10%	
Input Filter	Capacitor Type	
Output Voltage Accuracy	±5%	
Line Voltage Regulation	1,2% / 1% V Input	
Load Voltage Regulation (10% to 100% full load)	3.3V output type 5V output type 9V, 12V, 15V, 24V output types	20% max. 15% max. 10% max.
Ripple and Noise (20MHz limited)	150mVp-p max.	
Efficiency at Full Load	70% min.	
Isolation Voltage	1.000VDC min. (also available with 2.000VDC, Suffix „H“)	
Isolation Resistance (Viso = 500VDC)	10 GΩ min.	
Isolation Capacitance	40pF min./115pF max.	
Short Circuit Protection	1 Second	
Switching Frequency at Full Load	34kHz min. / 85kHz max.	
Operating Temperature	-40°C to +85°C (see Graph)	
Storage Temperature	-55°C to +125°C	
Package Weight	2.8g	

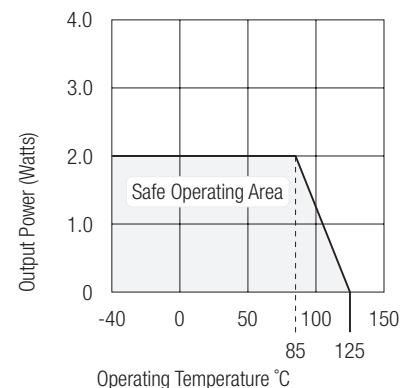

Package Style and Pinning (mm)

14 PIN DIP Package

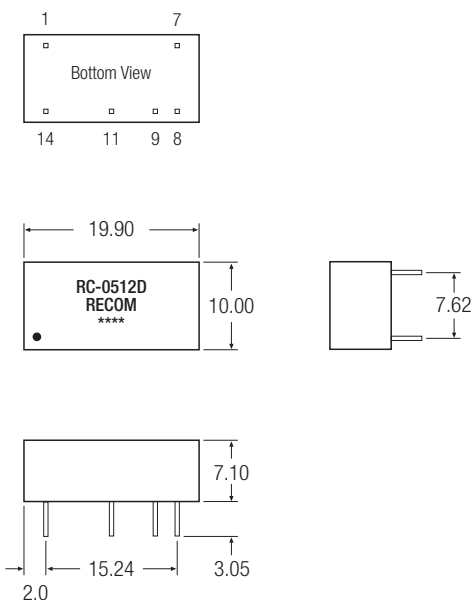

7 PIN SIP Package

3rd angle projection

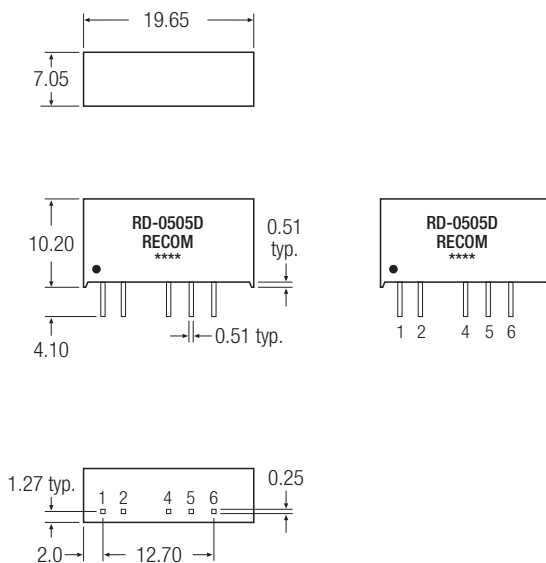

Recommended Footprint Details



Pin Connections

Pin #	RC	RD
1	-Vin	+Vin
2	No Pin	-Vin
4	No Pin	-Vout
5	No Pin	Com
6	No Pin	+Vout
7	NC	No Pin
8	Com	No Pin
9	+Vout	No Pin
11	-Vout	No Pin
14	+Vin	No Pin

XX.X ± 0.5 mm
XX.XX ± 0.25 mm