

Typical Applications

- Broadband Gain Blocks
- Low Noise Amplifiers
- IF or RF Buffer Amplifiers
- Driver Stage for Power Amplifiers
- Oscillator Loop Amplifiers
- Receiver Front-Ends

Product Description

The RF2323 is a general purpose, low-cost silicon amplifier designed for operation from a 3V supply. The circuit configuration with resistive feedback allows for broadband cascadable amplification. Capacitive compensation extends the bandwidth of the amplifier and input stage design optimizes noise figure. The device is unconditionally stable and internally matched to 50Ω. The only external components required for specified performance are bypass and DC blocking capacitors (as shown in application schematic). The RF2323 is available in a very small industry-standard SOT-23 5-lead surface mount package, enabling compact designs which conserve board space.

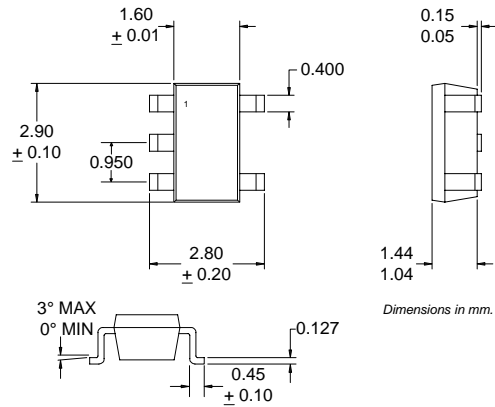

4  
GENERAL PURPOSE AMPLIFIERS

Optimum Technology Matching® Applied

- Si BJT       GaAs HBT       GaAs MESFET  
 Si Bi-CMOS       SiGe HBT       Si CMOS

Package Style: SOT 5-Lead

- Features
- DC to >2000MHz Operation
  - 2.7V to 3.3V Single Supply
  - 2.3dB Noise Figure
  - 21dB Gain at 900MHz
  - 12dB Gain at 1900MHz
  - High Isolation (33dB at 900MHz)

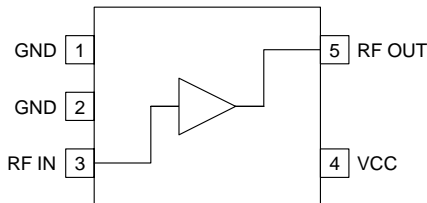

Functional Block Diagram

Ordering Information

RF2323      3V General Purpose Amplifier  
 RF2323 PCBA      Fully Assembled Evaluation Board

RF Micro Devices, Inc.      Tel (336) 664 1233  
 7628 Thorndike Road      Fax (336) 664 0454  
 Greensboro, NC 27409, USA      <http://www.rfmd.com>

### Absolute Maximum Ratings

Parameter	Rating	Unit
Supply Voltage	4.0	V
Operating Ambient Temperature	-40 to +85	°C
Storage Temperature	-40 to +150	°C



**Caution!** ESD sensitive device.

RF Micro Devices believes the furnished information is correct and accurate at the time of this printing. However, RF Micro Devices reserves the right to make changes to its products without notice. RF Micro Devices does not assume responsibility for the use of the described product(s).

4

GENERAL PURPOSE  
AMPLIFIERS

Parameter	Specification			Unit	Condition
	Min.	Typ.	Max.		
<b>Overall</b>					
Frequency Range		DC to >2000		MHz	T=27 °C, V <sub>CC</sub> =3.0V
<b>100MHz Performance</b>					T=27 °C, V <sub>CC</sub> =3.0V
Gain		20		dB	
Noise Figure		2.0		dB	
Output IP3		5		dBm	
Output P <sub>1dB</sub>		-6		dBm	
Input Return Loss		19		dB	
Output Return Loss		12		dB	
Isolation		50		dB	
<b>500MHz Performance</b>					T=27 °C, V <sub>CC</sub> =3.0V
Gain		19		dB	
Noise Figure		2.3		dB	
Output IP3		4		dBm	
Output P <sub>1dB</sub>		-6		dBm	
Input Return Loss		9		dB	
Output Return Loss		11		dB	
Isolation		41		dB	
<b>900MHz Performance</b>	19.0		21.5		T=27 °C, V <sub>CC</sub> =3.0V
Gain		21		dB	
Noise Figure		2.3		dB	
Output IP3		2		dBm	
Output P <sub>1dB</sub>		-7		dBm	
Input Return Loss		6		dB	
Output Return Loss		8		dB	
Isolation		33		dB	
<b>1000MHz Performance</b>					T=27 °C, V <sub>CC</sub> =3.0V
Gain		20		dB	
Noise Figure		2.3		dB	
Output IP3		2		dBm	
Output P <sub>1dB</sub>		-7		dBm	
Input Return Loss		6		dB	
Output Return Loss		8		dB	
Isolation		32		dB	
<b>2000MHz Performance</b>					T=27 °C, V <sub>CC</sub> =3.0V
Gain		12		dB	
Noise Figure		4.0		dB	
Output IP3		3		dBm	
Output P <sub>1dB</sub>		-7		dBm	
Input Return Loss		14		dB	
Output Return Loss		20		dB	
Isolation		27		dB	
<b>Power Supply</b>					
Operating Voltage		3.0±10%		V	V <sub>CC</sub> =3.0V
Operating Current		6.8		mA	

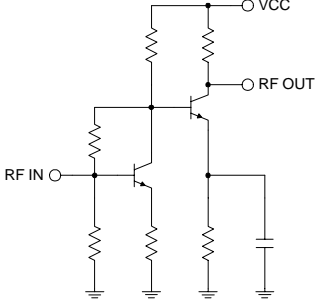
Pin	Function	Description	Interface Schematic
1	GND	Ground connection. Keep traces physically short and connect immediately to ground plane for best performance.	
2	GND	Same as pin 1.	
3	RF IN	RF input pin. This pin is not internally DC blocked and thus requires an external blocking capacitor suitable for the frequency of operation. The input impedance of this pin is internally matched to 50Ω using resistive feedback.	
4	VCC	Supply connection. This pin should be bypassed with a suitable capacitor(s).	
5	RF OUT	RF output and bias pin. The output impedance of this pin is internally matched to 50Ω using resistive feedback. Because DC biasing is present on this pin, a DC blocking capacitor should be used in most applications (see application schematic).	See pin 3 schematic.

4  
GENERAL PURPOSE  
AMPLIFIERS

### Application Schematic

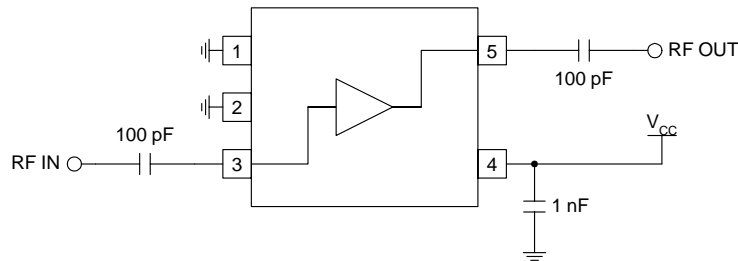

### Evaluation Board Schematic

(Download [Bill of Materials](http://www.rfmd.com) from [www.rfmd.com](http://www.rfmd.com).)

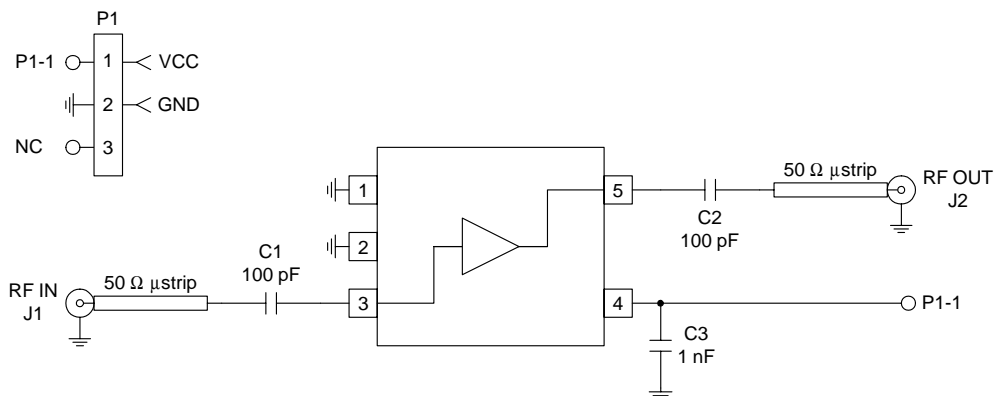

Evaluation Board Layout  
1" x 1"

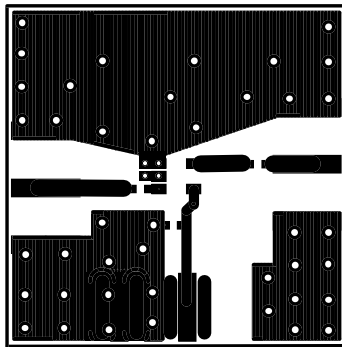
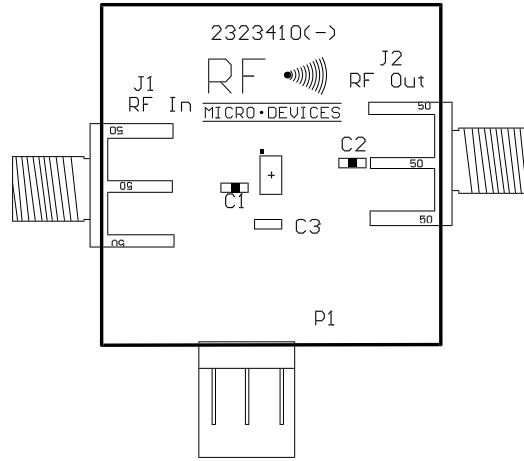

4

GENERAL PURPOSE  
AMPLIFIERS

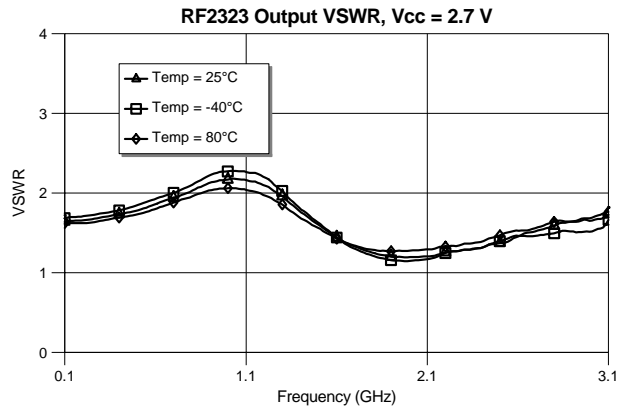
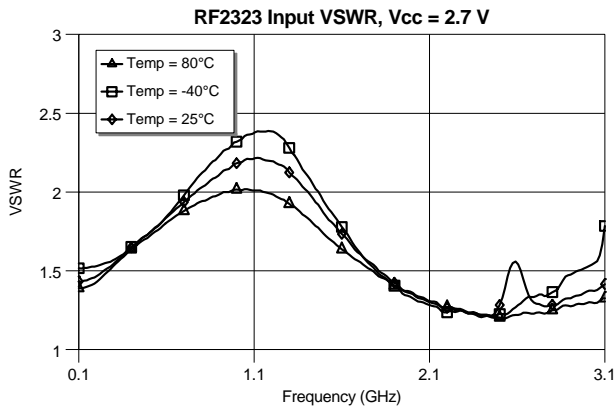
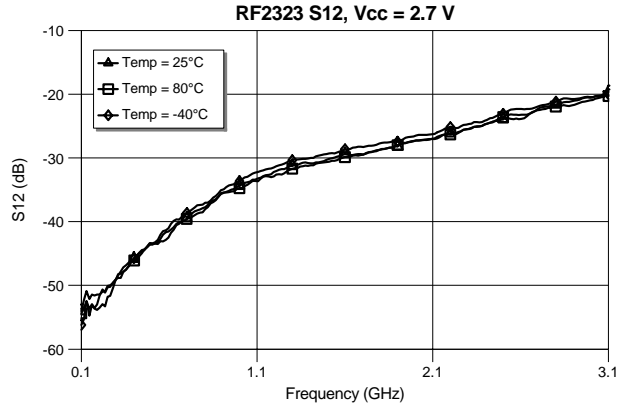
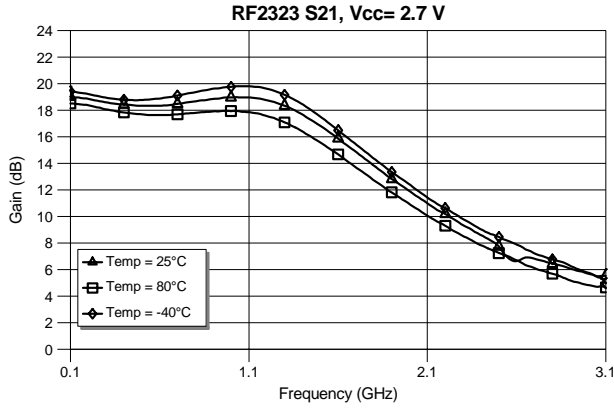

**RF2323 S11, Vcc = 2.7 V, Temp = 25°C**

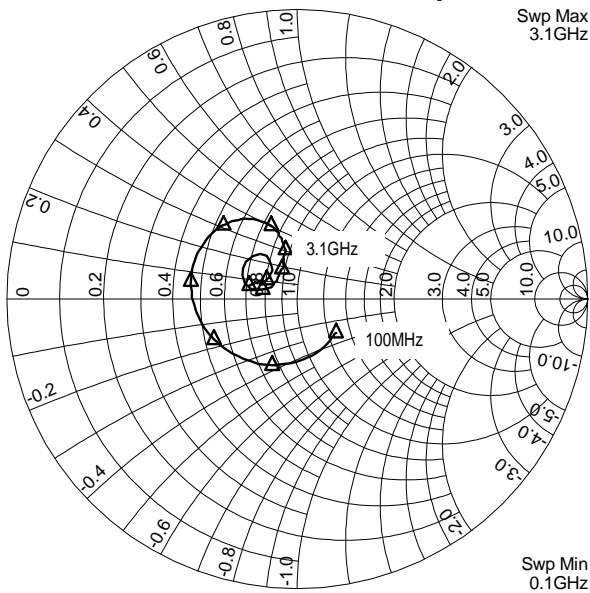

**RF2323 S22, Vcc = 2.7 V, Temp= 25°C**

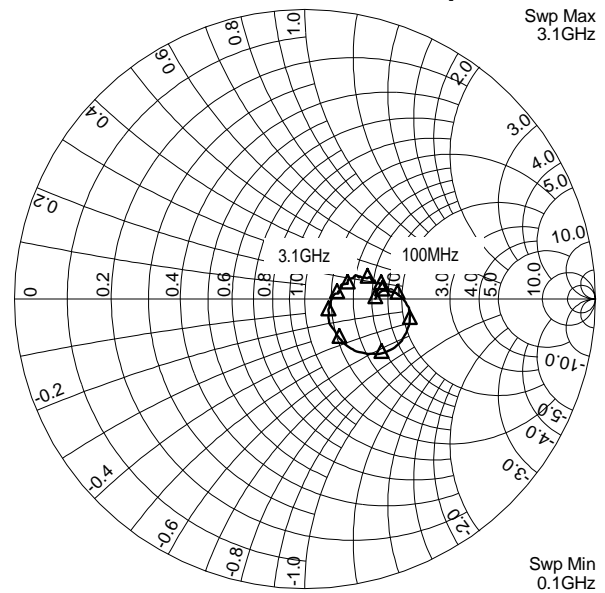

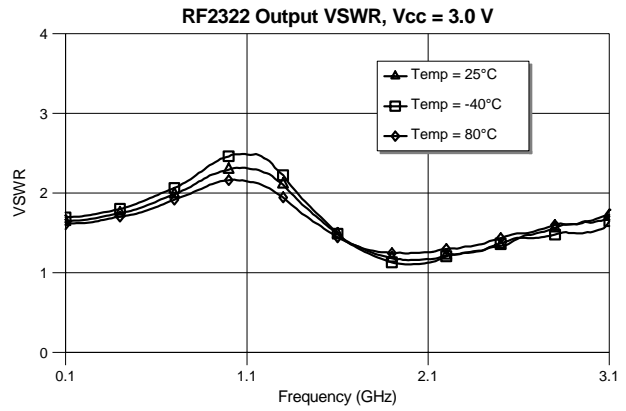
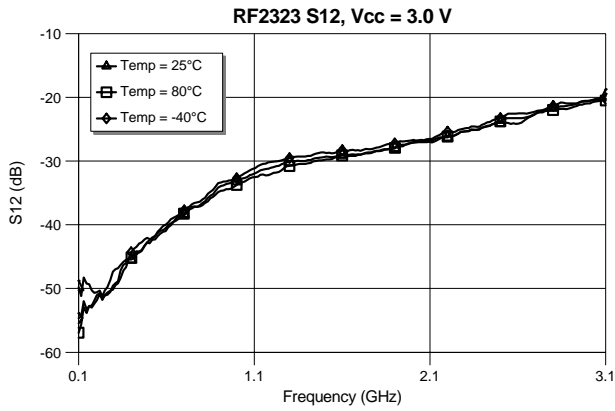
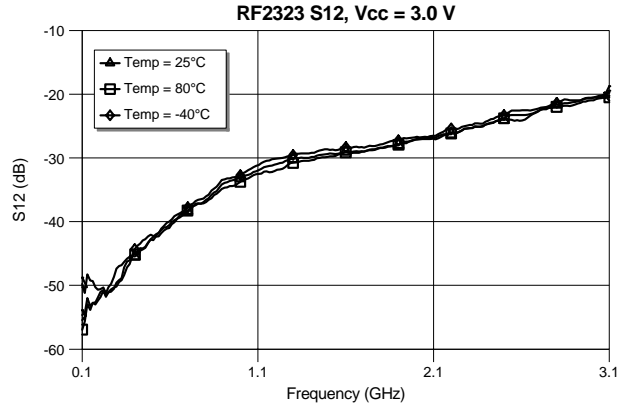
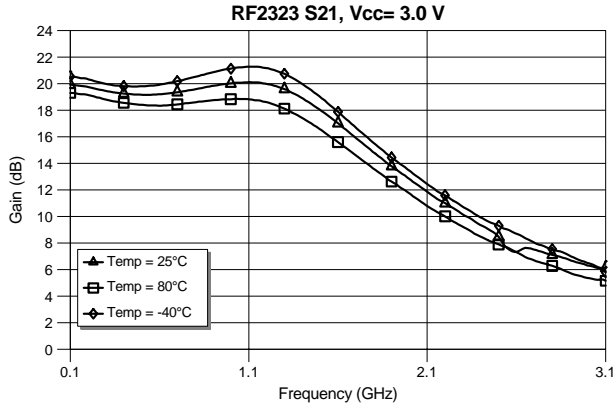

**RF2323 S11, Vcc = 3.0 V, Temp = 25°C**

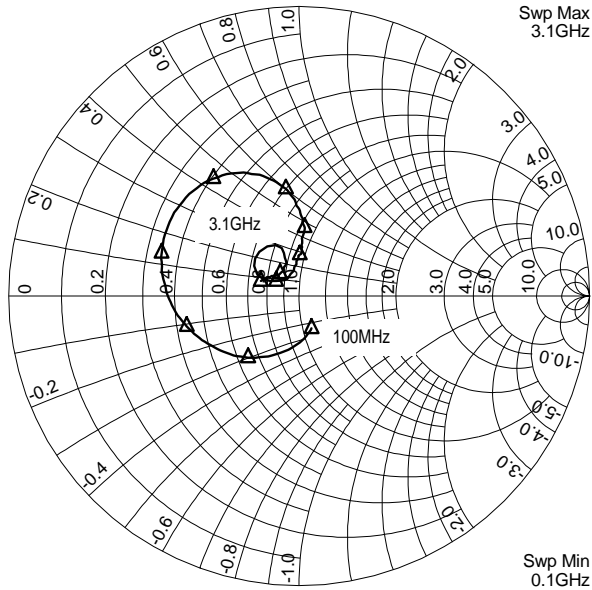

**RF2323 S22, Vcc = 3.0 V, Temp = 25°C**

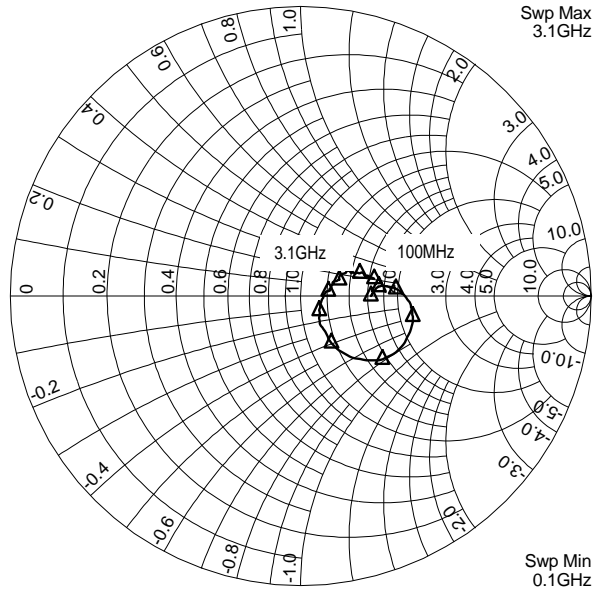

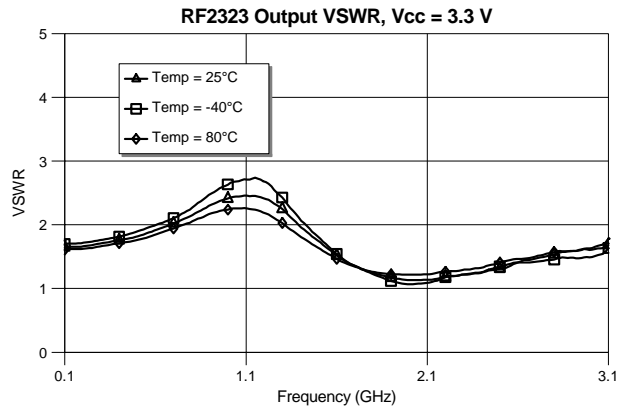
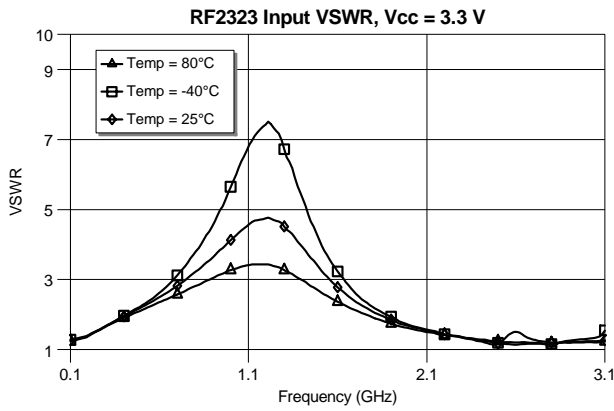
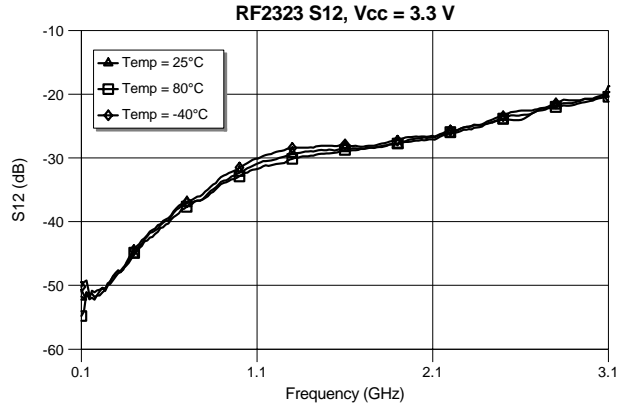
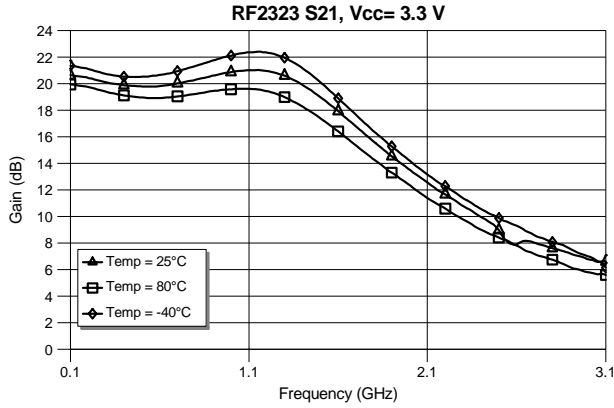

**RF2323 S11, Vcc = 3.3 V, Temp = 25°C**

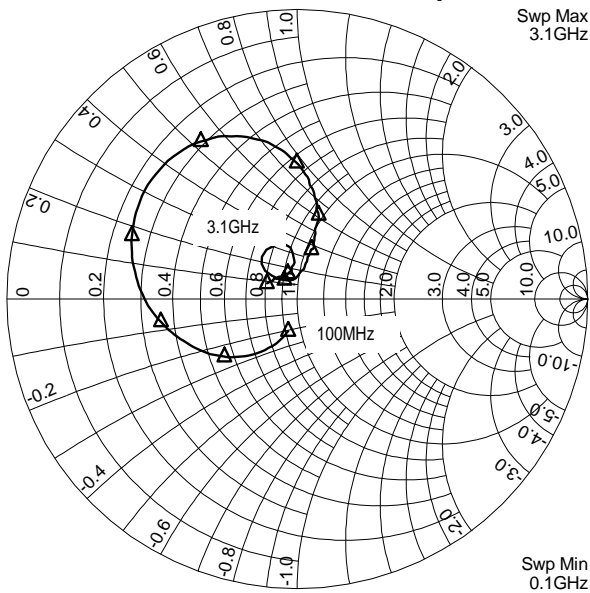

**RF2323 S22, Vcc = 3.3 V, Temp= 25°C**

