

Typical Applications

- CDMA/FM Cellular Systems
- Supports Dual-Mode AMPS/CDMA
- Supports Dual-Mode TACS/JCDMA
- General Purpose Downconverter
- Commercial and Consumer Systems
- Portable Battery-Powered Equipment

Product Description

The RF2461 is a receiver front-end designed for the receive section of dual-mode CDMA/FM cellular applications. It is designed to amplify and downconvert RF signals, while providing 30dB of stepped gain control range. Features include digital control of LNA gain, mixer gain, and power down mode. Another feature of the chip is adjustable IIP3 of the LNA and mixer using an off-chip current setting resistor. Noise figure, IP3, and other specs are designed to be compatible with the IS-98B interim standard for CDMA cellular communications. The IC is manufactured on an advanced Silicon Germanium HBT process and is in a 4mmx4mm, 20-pin, leadless chip carrier.

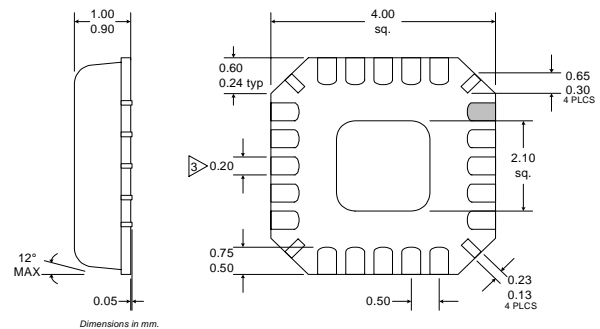

- NOTES:
- 1 Shaded lead is Pin 1.
  - 2 Pin 1 identifier must exist on top surface of package by identification mark or feature on the package body. Exact shape and size is optional.
  - 3 Dimension applies to plated terminal: to be measured between 0.02 mm and 0.25 mm from terminal end.
  - 4 Package Warpage: 0.05 mm max.
  - 5 Die Thickness Allowable: 0.305 mm max.

Optimum Technology Matching® Applied

- |                                     |  |                                      |
|-------------------------------------|--|--------------------------------------|
| <input type="checkbox"/> Si BJT     | <input type="checkbox"/> GaAs HBT            | <input type="checkbox"/> GaAs MESFET |
| <input type="checkbox"/> Si Bi-CMOS | <input checked="" type="checkbox"/> SiGe HBT | <input type="checkbox"/> Si CMOS     |

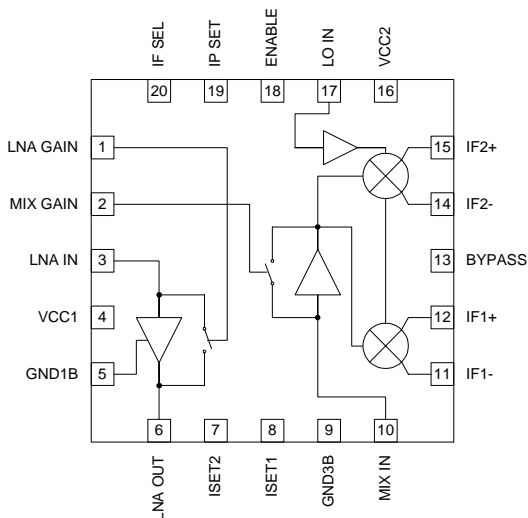

Functional Block Diagram

Package Style: LCC, 20-Pin, 4 x 4

Features

- Complete Receiver Front-End
- Stepped LNA/Mixer Gain Control
- Adjustable LNA/Mixer Bias Current
- Adjustable LNA/Mixer IIP3
- Meets IMD Tests with Three Gain States/ Two Logic Control Lines

Ordering Information

- |             |  |
|-------------|--|
| RF2461      | CDMA/FM Low Noise Amplifier/Mixer 900MHz Downconverter |
| RF2461 PCBA | Fully Assembled Evaluation Board                       |

|  |   |
|--|---|
| RF Micro Devices, Inc.<br>7625 Thorndike Road<br>Greensboro, NC 27409, USA | Tel (336) 664 1233<br>Fax (336) 664 0454<br><a href="http://www.rfmd.com">http://www.rfmd.com</a> |
|--|---|

### Absolute Maximum Ratings

| Parameter                     | Rating       | Unit            |
|-------------------------------|--------------|-----------------|
| Supply Voltage                | -0.5 to +5.0 | V <sub>DC</sub> |
| Input LO and RF Levels        | +6           | dBm             |
| Operating Ambient Temperature | -40 to +85   | °C              |
| Storage Temperature           | -40 to +150  | °C              |



**Caution!** ESD sensitive device.

RF Micro Devices believes the furnished information is correct and accurate at the time of this printing. However, RF Micro Devices reserves the right to make changes to its products without notice. RF Micro Devices does not assume responsibility for the use of the described product(s).

| Parameter                             | Specification |                          |      | Unit | Condition   |
|---------------------------------------|---------------|--------------------------|------|------|---|
|                                       | Min.          | Typ.                     | Max. |      |   |
| <b>Overall</b>                        |               |                          |      |      | T = 25°C, V <sub>CC</sub> = 3.0V<br>CDMA: RF = 880MHz, IF = 85MHz,<br>LO = 965MHz @ -10dBm<br>JCDMA: RF = 851MHz, IF = 110MHz,<br>LO = 741MHz @ -4dBm |
| RF Frequency Range                    | 800           | 869 to 894<br>832 to 870 | 1000 | MHz  |   |
| LO Frequency Range                    | 700           | 954 to 979<br>722 to 760 | 1000 | MHz  |   |
| IF Frequency Range                    | 0.1           |                          | 250  | MHz  |   |
| <b>LNA - CDMA</b>                     |               |                          |      |      |   |
| Gain                                  | 13.5          | 14.5                     | 15   | dB   | IIP3 is adjustable. V <sub>IPSET</sub> = 0V   |
| Noise Figure                          |               | 1.8                      | 2    | dB   |   |
| Input IP3                             | +7.0          | +9.0                     |      | dBm  |   |
| Current                               |               | 5                        |      | mA   |   |
| <b>LNA Bypass - CDMA</b>              |               |                          |      |      |   |
| Gain                                  | -8            | -6                       |      | dB   |   |
| Input IP3                             | +16.0         | +18.0                    |      | dBm  |   |
| Current                               |               | 0                        |      | mA   |   |
| <b>LNA - JCDMA</b>                    |               |                          |      |      |   |
| Gain                                  | 14            | 15                       | 16   | dB   | IIP3 is adjustable. V <sub>IPSET</sub> = 3V   |
| Noise Figure                          |               | 1.8                      | 2    | dB   |   |
| Input IP3                             | +9.0          | +11.0                    |      | dBm  |   |
| Current                               |               | 6.5                      |      | mA   |   |
| <b>LNA Bypass - JCDMA</b>             |               |                          |      |      |   |
| Gain                                  | -9            | -7                       |      | dB   |   |
| Input IP3                             | +20.0         | +24.0                    |      | dBm  |   |
| Current                               |               | 0                        |      | mA   |   |
| <b>Mixer - High Gain Mode - CDMA</b>  |               |                          |      |      | 3kΩ balanced load.  |
| Gain                                  | 13            | 14.5                     |      | dB   | IIP3 is adjustable. Decreasing R4/R5 will increase IIP3.  |
| Noise Figure                          |               | 5.5                      | 7    | dB   |   |
| Input IP3                             | +3.0          | +4.0                     |      | dBm  |   |
| RF to IF Isolation                    |               |                          |      | dB   |   |
| Current<br>(including LO Buffer/Bias) |               | 21                       |      | mA   |   |
| <b>Mixer - Low Gain Mode - CDMA</b>   |               |                          |      |      |   |
| Gain                                  | 4             | 5.8                      |      | dB   |   |
| Noise Figure                          |               | 13                       | 14   | dB   |   |
| IIP3                                  | +13.0         | +14.0                    |      | dBm  |   |
| RF to IF Isolation                    |               |                          |      | dB   |   |
| Current<br>(including LO Buffer/Bias) |               | 18                       |      | mA   |   |

| Parameter                             | Specification |       |      | Unit | Condition  |
|---------------------------------------|---------------|-------|------|------|--|
|                                       | Min.          | Typ.  | Max. |      |  |
| <b>Mixer - High Gain Mode - JCDMA</b> |               |       |      |      | 3kΩ balanced load.   |
| Gain                                  | 12            | 13    |      | dB   |  |
| Noise Figure                          |               | 5.5   | 7    | dB   |  |
| Input IP3                             | +2.0          | +3.0  |      | dBm  | IIP3 is adjustable. Decreasing R4/R5 will increase IIP3.                   |
| Current<br>(including LO Buffer/Bias) |               | 24    |      | mA   |  |
| <b>Mixer - Low Gain Mode - JCDMA</b>  |               |       |      |      |  |
| Gain                                  | 2.5           | 4.0   |      | dB   |  |
| Noise Figure                          |               | 13    | 14   | dB   |  |
| IIP3                                  | +10.0         | +12.0 |      | dBm  |  |
| Current<br>(including LO Buffer/Bias) |               | 21    |      | mA   |  |
| <b>Local Oscillator Input</b>         |               |       |      |      |  |
| Input Level                           |               | -10   |      | dBm  |  |
| LO to IF Isolation                    |               | -70   |      | dB   |  |
| LO to LNA Isolation                   |               | -60   |      | dB   | Any gain state.  |
| <b>Cascade - LNA High/Mixer High</b>  |               |       |      |      | LNA High Gain/Mixer High Gain.<br>Assumes 3dB Image filter insertion loss. |
| Gain                                  | 23.5          | 26    | 28   | dB   |  |
| Noise Figure                          |               | 2.4   |      | dB   |  |
| Input IP3                             | -11           | -9    | 0    | dBm  |  |
| Current                               |               | 26    |      | mA   |  |
| <b>Cascade - LNA High/Mixer Low</b>   |               |       |      |      | LNA High Gain/Mixer Low Gain.<br>Assumes 3dB Image filter insertion loss.  |
| Gain                                  |               | 16.5  |      | dB   |  |
| Noise Figure                          |               | 4.9   |      | dB   |  |
| Input IP3                             |               | 0     |      | dBm  |  |
| Current                               |               | 23    |      | mA   |  |
| <b>Cascade - LNA Low/Mixer High</b>   |               |       |      |      | LNA Low Gain/Mixer High Gain.<br>Assumes 3dB Image filter insertion loss.  |
| Gain                                  |               | 4     |      | dB   |  |
| Noise Figure                          |               | 15.5  |      | dB   |  |
| Input IP3                             |               | 11.8  |      | dBm  |  |
| Current                               |               | 22    |      | mA   |  |
| <b>Cascade - LNA Low/Mixer Low</b>    |               |       |      |      | LNA Low Gain/Mixer Low Gain.<br>Assumes 3dB Image filter insertion loss.   |
| Gain                                  | -7            | -4.5  | -3   | dB   |  |
| Noise Figure                          |               | 22.5  |      | dB   |  |
| Input IP3                             | +14           | +20   | 40   | dBm  |  |
| Current                               |               | 18    |      | mA   |  |
| <b>Power Supply</b>                   |               |       |      |      |  |
| Voltage                               | 2.65          | 3.0   | 3.15 | V    |  |

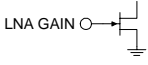
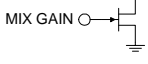
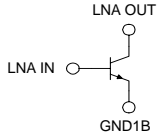
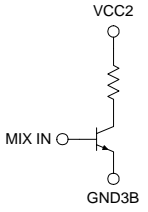
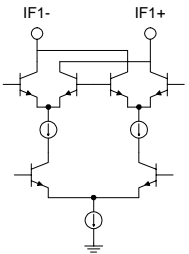
| Pin | Function        | Description   | Interface Schematic   |
|-----|-----------------|---|---|
| 1   | <b>LNA GAIN</b> | Controls the bypass feature of the LNA. A logic low (<1.0V) selects the bypass mode. A logic high (>2.0V) turns on the LNA.   |    |
| 2   | <b>MIX GAIN</b> | Controls the bypass feature of the mixer pre-amp. A logic low (<1.0V) selects the bypass mode. A logic high (>2.0V) turns on the pre-amp.   |    |
| 3   | <b>LNA IN</b>   | LNA input pin.  |    |
| 4   | <b>VCC1</b>     | VCC pin for all circuits except the LO. Buffer/bias circuitry.  |   |
| 5   | <b>GND1B</b>    | LNA emitter. This pin provides the DC path to ground for the LNA. A lumped element or a transmission line inductor can be placed between this pin and ground to degenerate the LNA. This will decrease the gain, increase the IP3, and increase the NF of the LNA. As the value of inductance is increased, these effects will become more pronounced.      |   |
| 6   | <b>LNA OUT</b>  | LNA output pin.   | See pin 3.  |
| 7   | <b>ISET2</b>    | An external resistor R2 connected to this pin sets the current of the pre-amp and the mixer.  |   |
| 8   | <b>ISET1</b>    | An external resistor R3 connected to this pin sets the current of the LNA when IP SET is high (see pin 19).   |   |
| 9   | <b>GND3B</b>    | Ground pin for pre-amp circuit. A 3.3nH inductor is used between pin 9 and ground to degenerate the mixer pre-amp. Degenerating the pre-amp will reduce the gain, increase the IP3 and affect the pre-amp input impedance.  |  |
| 10  | <b>MIX IN</b>   | Mixer pre-amp input pin.  | See pin 9.  |
| 11  | <b>IF1-</b>     | Second differential output pin for the first mixer.   | See pin 12.   |
| 12  | <b>IF1+</b>     | First differential output pin for the first mixer. Open collector. A current combiner external network performs a differential to single-ended conversion and sets the output impedance. A DC blocking cap must be present if the IF filter input has a DC path to ground. Mixer (IF2+ and IF-) needs to "see" a differential impedance between 2kΩ to 4kΩ. |  |
| 13  | <b>BYPASS</b>   | Bypass pin for the LO bias reference.   |   |
| 14  | <b>IF2-</b>     | Second differential output pin for the second mixer.  | See pin 15.   |

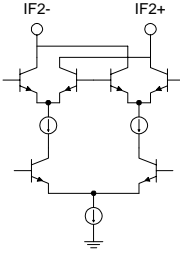
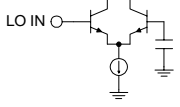
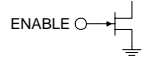
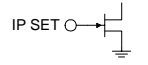
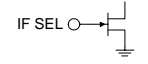
| Pin      | Function | Description   | Interface Schematic   |
|----------|----------|---|---|
| 15       | IF2+     | First differential output pin for the second mixer. Open collector. A current combiner external network performs a differential to single-ended conversion and sets the output impedance. A DC blocking cap must be present if the IF filter input has a DC path to ground. Mixer (IF2+ and IF2-) needs to “see” a differential impedance between 2kΩ to 4kΩ. |    |
| 16       | VCC2     | VCC pin for the LO buffer/bias circuitry.*  |   |
| 17       | LO IN    | LO limiter input pin.   |    |
| 18       | ENABLE   | This pin is used to enable or disable the RF2461. A logic high (>2.0V) enables the circuitry. A logic low (<1.0V) disables the circuitry.   |    |
| 19       | IP SET   | Controls the setting of the LNA current. A logic low (<1.0V) selects the internal resistance (49.5kΩ), resulting in an LNA current of 5mA. A logic high (>2.0V) selects the external resistance at pin 8.   |    |
| 20       | IF SEL   | Determines which IF port is active. A logic low (<1.0V) activates IF1 and deactivates IF2. A logic high (>2.0V) activates IF2 and deactivates IF1.  |  |
| Pkg Base | GND      | Ground connection. The backside of the package should be soldered to a top side ground pad which is connected to the ground plane with multiple vias.   |   |

\*The bias circuitry current drop when LO signal is not present. Total LO buffer/bias circuitry current is 7 mA when LO signal is present.

**Application Schematic**

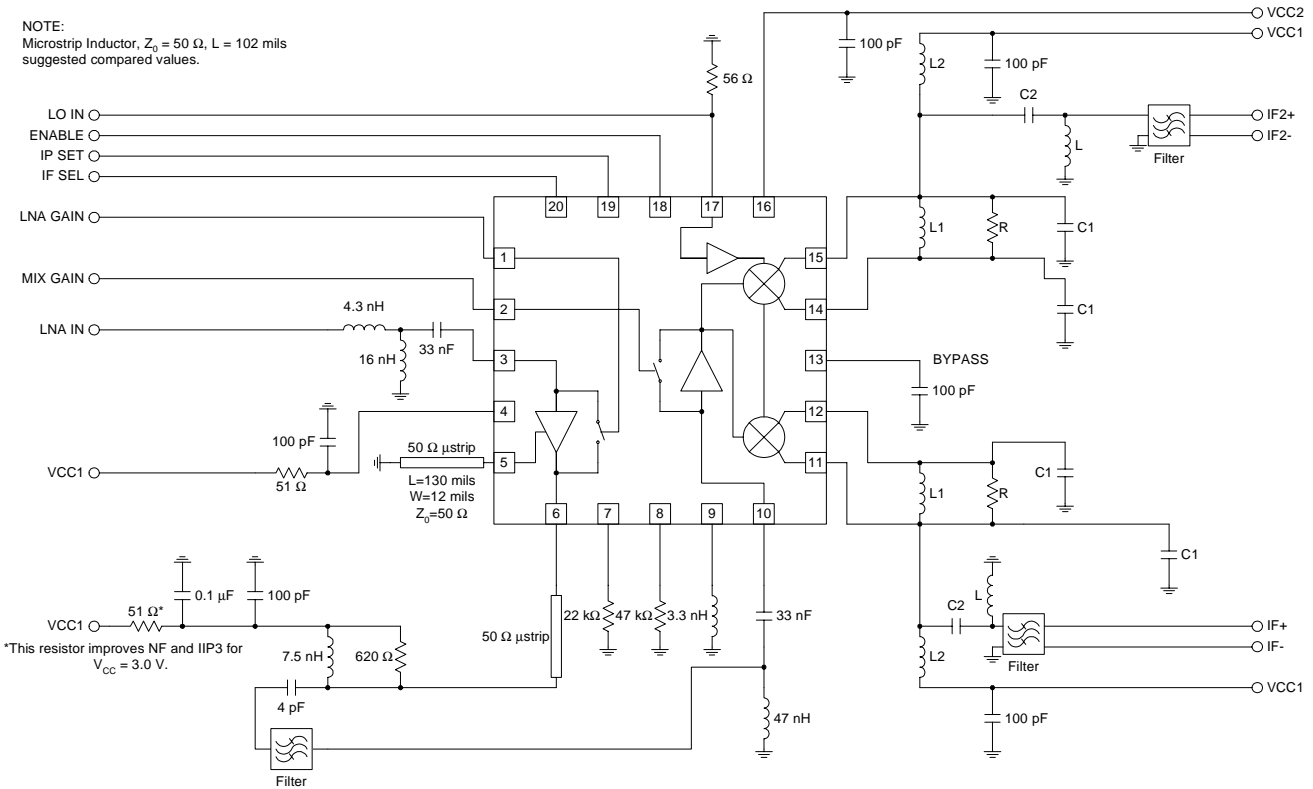

**Output Interface Network**

L1, C1, and R form a current combiner which performs a differential to single-ended conversion at the IF frequency and sets the output impedance. In most cases, the resonance frequency is independent of R and can be set according to the following equation:

$$f_{IF} = \frac{1}{2\pi\sqrt{\frac{L1}{2}(C1 + C_{EQ})}}$$

Where  $C_{EQ}$  is the equivalent stray capacitance and capacitance looking into pins 11 and 12. An average value to use for  $C_{EQ}$  is 2.5pF to 3pF.

R can then be used to set the output impedance according to the following equation:

$$R = \left( \frac{1}{4 \cdot R_{OUT}} - \frac{1}{R_P} \right)^{-1}$$

where  $R_{OUT}$  is the desired output impedance and  $R_P$  is the parasitic equivalent parallel resistance of L1.

C1 should be chosen as high as possible (not greater than 15pF), while maintaining an  $R_P$  of L1 that allows for the desired  $R_{OUT}$ .

L2 and C2 serve dual purposes. L2 serves as an output bias choke, and C2 serves as a series DC block.

In addition, L2 and C2 may be chosen to form an impedance matching network if the input impedance of the IF filter is not equal to  $R_{OUT}$ . Otherwise, L2 is chosen to be large, and C2 is chosen to be large if a DC path to ground is present in the IF filter, or omitted if the filter is DC blocked.

Evaluation Board Schematic - CDMA  
 LO@965MHz, RF@880MHz, IF@85MHz  
 (Download [Bill of Materials](http://www.rfmd.com) from www.rfmd.com.)

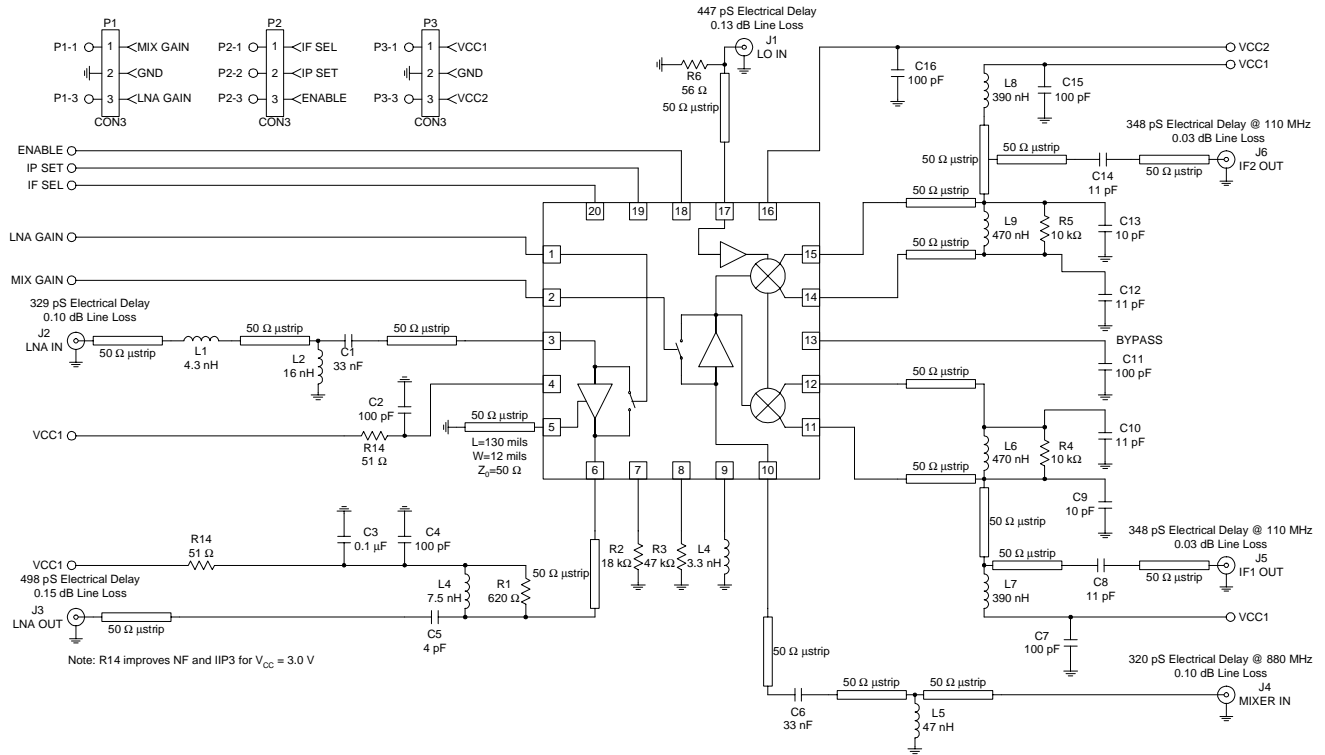

## Evaluation Board Schematic - JCDMA LO@741MHz, RF@851MHz, IF@110MHz

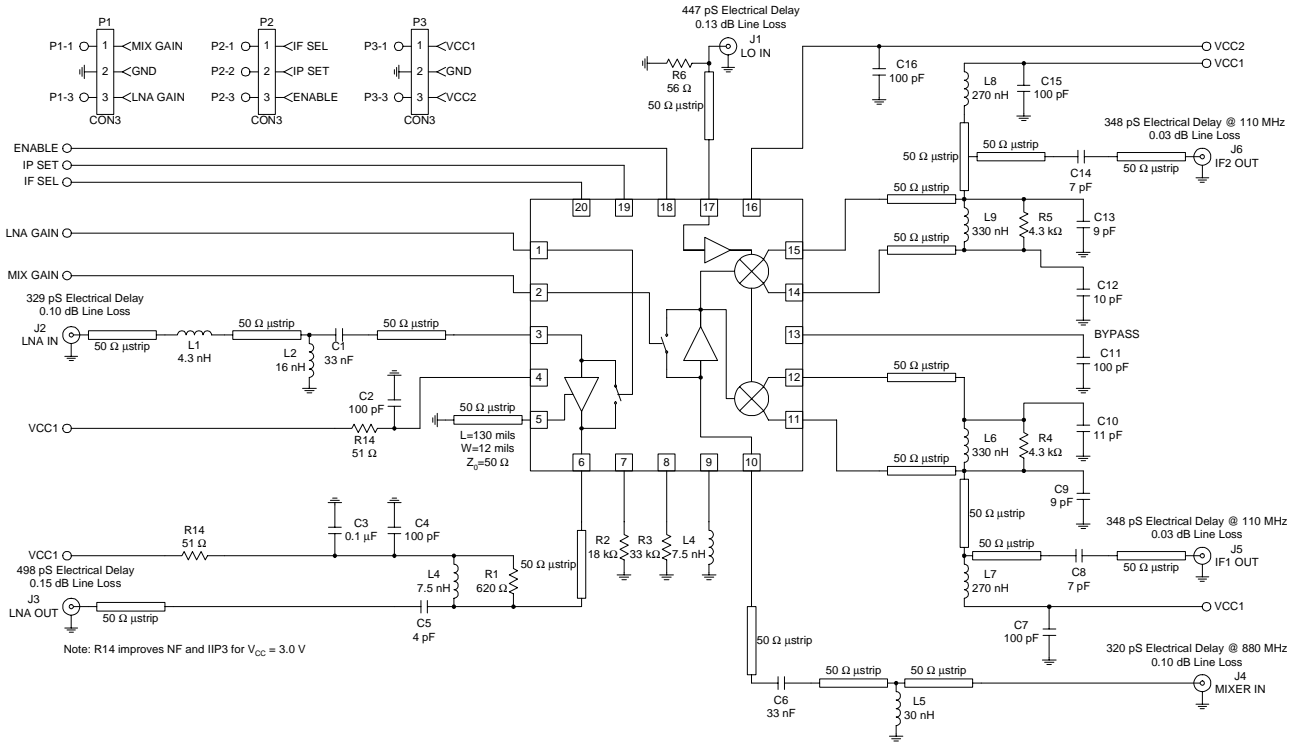



### Evaluation Board Layout Board Size 2.0" x 2.0"

Board Thickness 0.031", Board Material FR-4, Multi-Layer

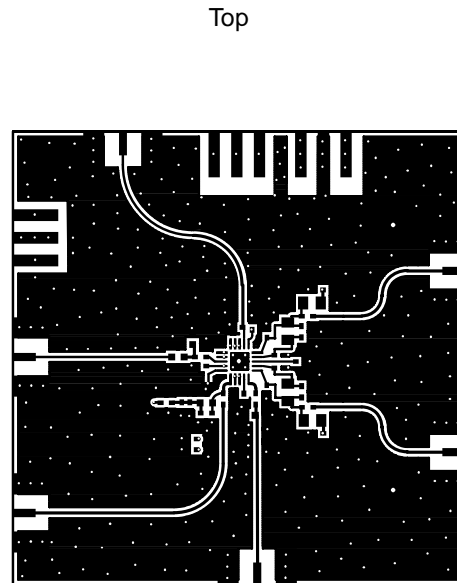
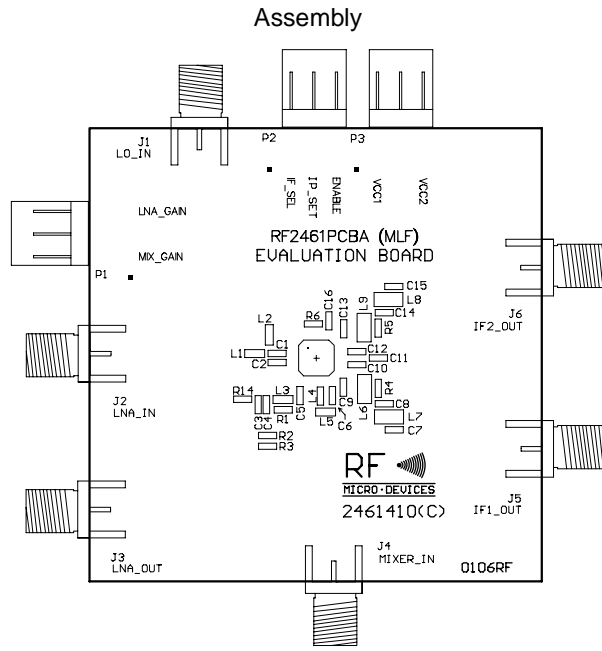

Power Plane 1

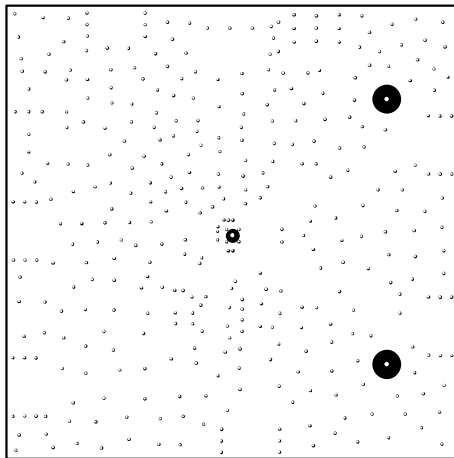

Power Plane 2

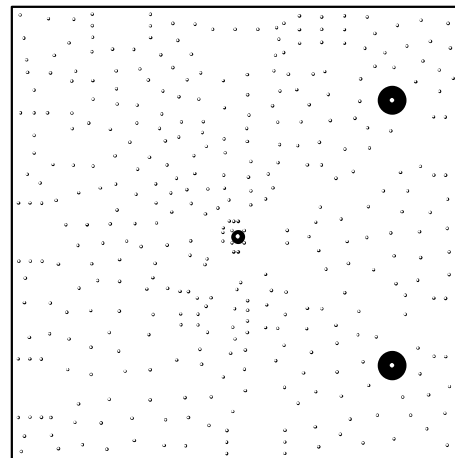

Back

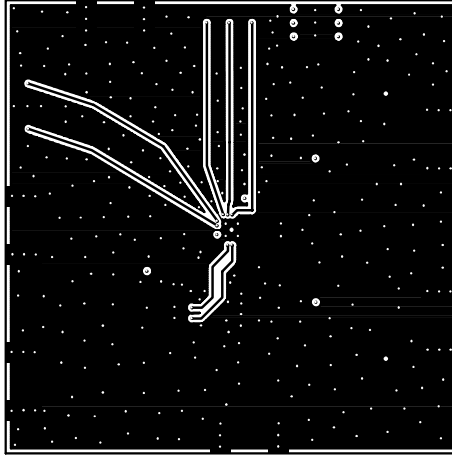

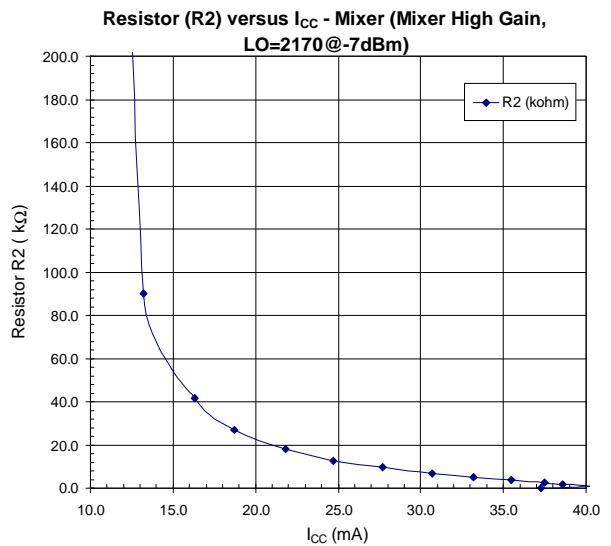
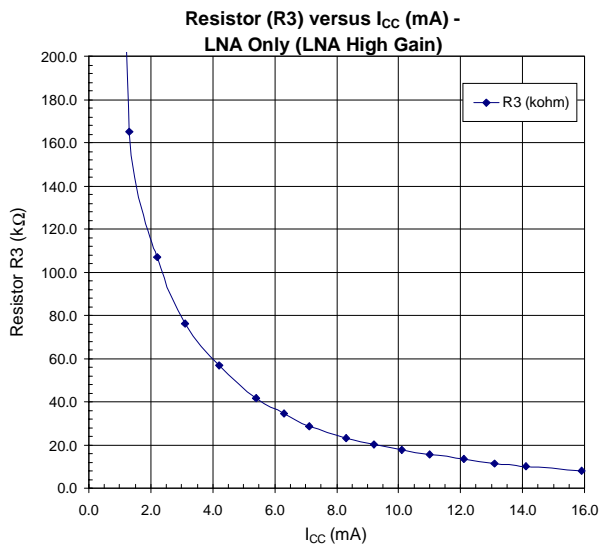
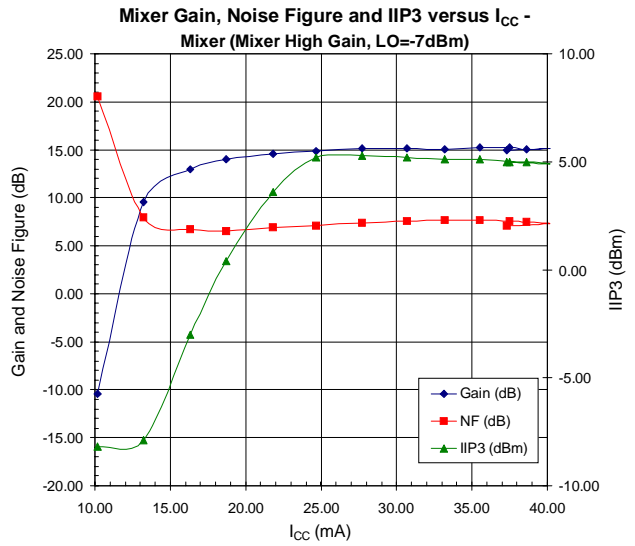
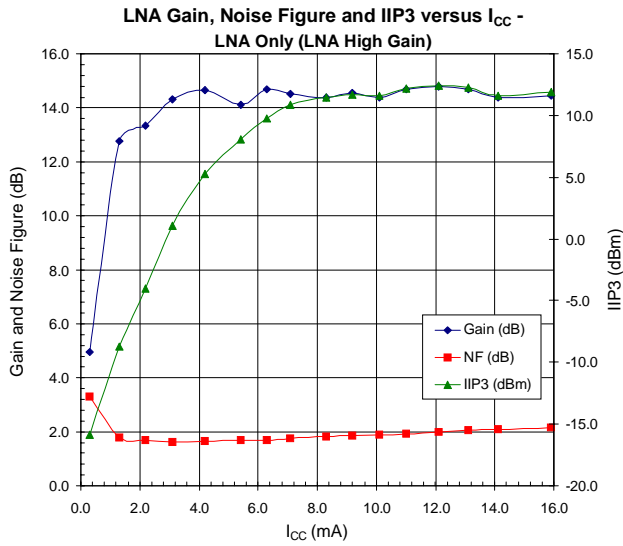

Condition T=25°C, VCC=2.75V, RF=880 and 881MHz, LO=965MHz @-10dBm

|            | IP_SET | IF_SEL | LNA_GAIN | MIX_GAIN | ENABLE |
|------------|--------|--------|----------|----------|--------|
| MIXER_GAIN | 0      | 0      | 0        | 1        | 1      |
| LNA_GAIN1  | 1      | 0      | 0        | 0        | 1      |
| LNA_GAIN2  | 1      | 0      | 1        | 0        | 1      |

LNA Current=LNA Gain2-LNA-Gain1

LNA (Low Gain Mode)

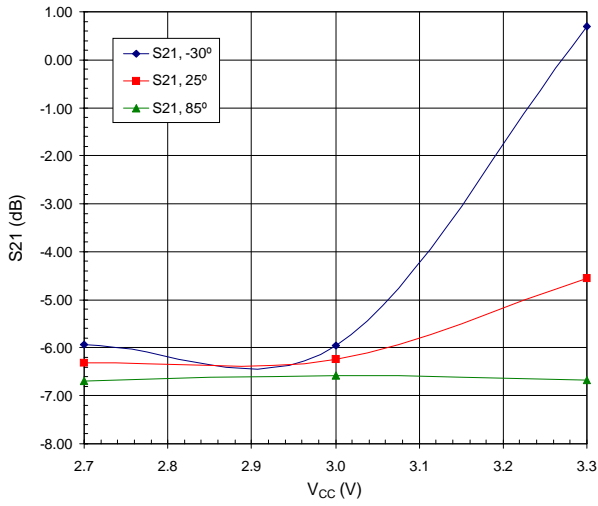

LNA (Low Gain Mode)

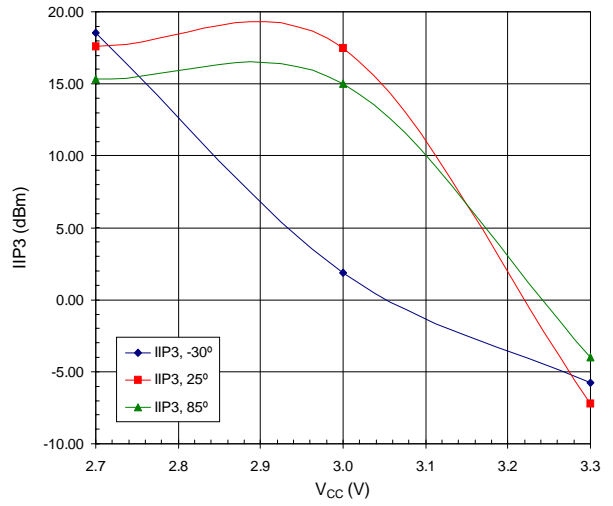

LNA (High Gain/Low IP Mode)

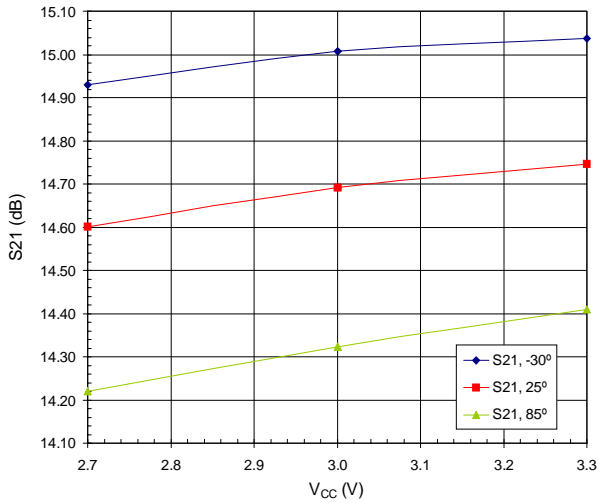

LNA (High Gain/Low IP Mode)

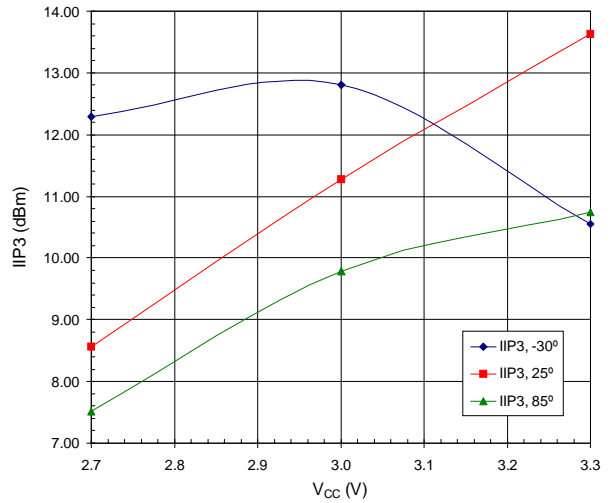

LNA (High Gain/Low IP Mode)

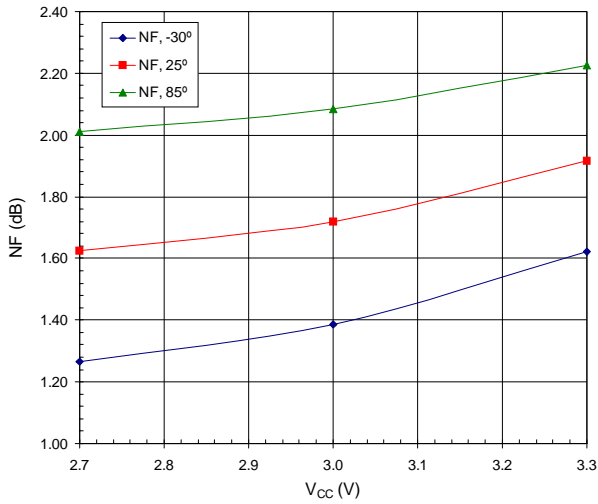

LNA (High Gain/High IP Mode)

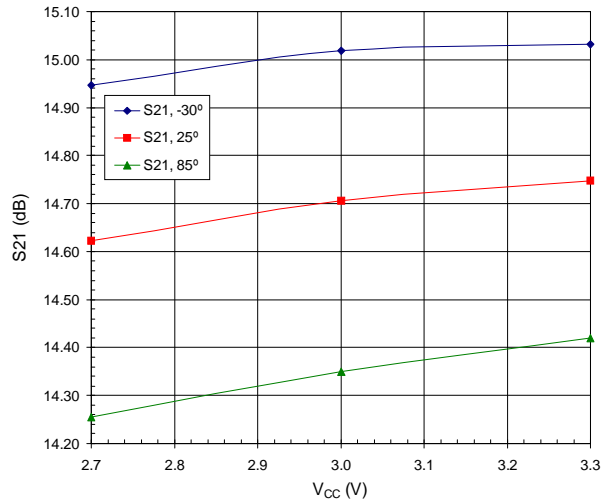

LNA (High Gain/High IP mode)

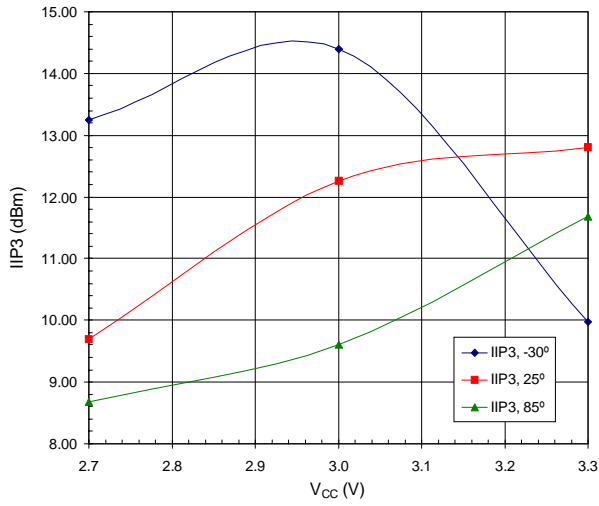

LNA (High Gain/High IP Mode)

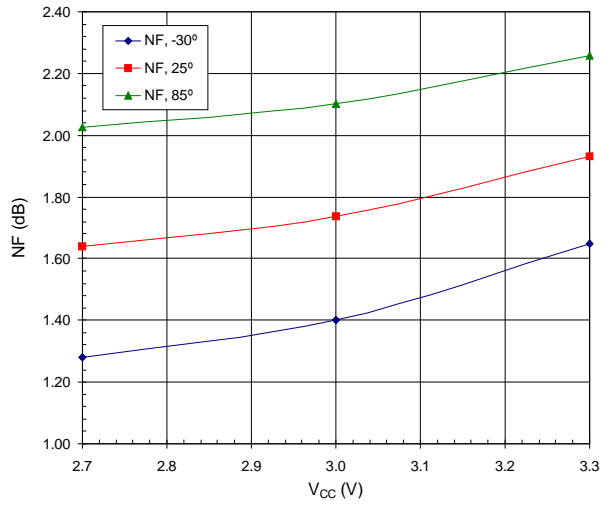

VCC versus I<sub>CC</sub>, LNA High Mode, Low IP

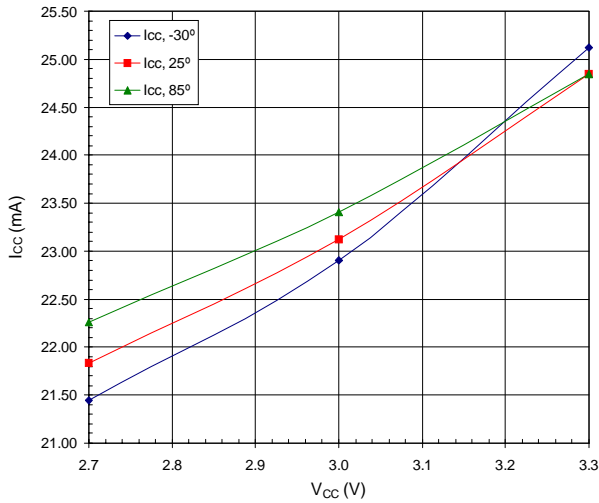

VCC versus I<sub>CC</sub>, LNA High Mode, High IP

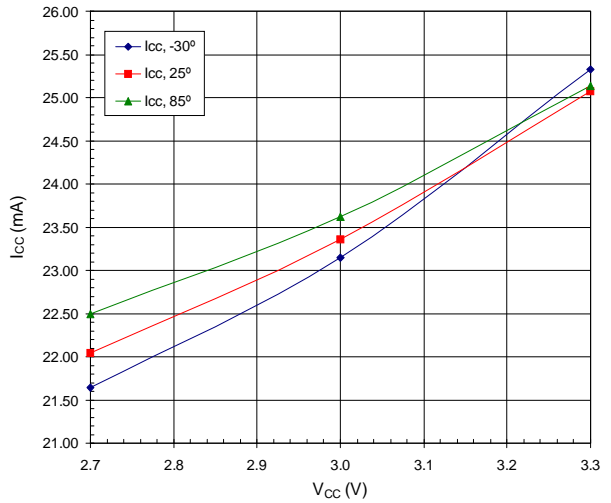

Mixer (IF1), Low Gain Mode, LO@-10dBm

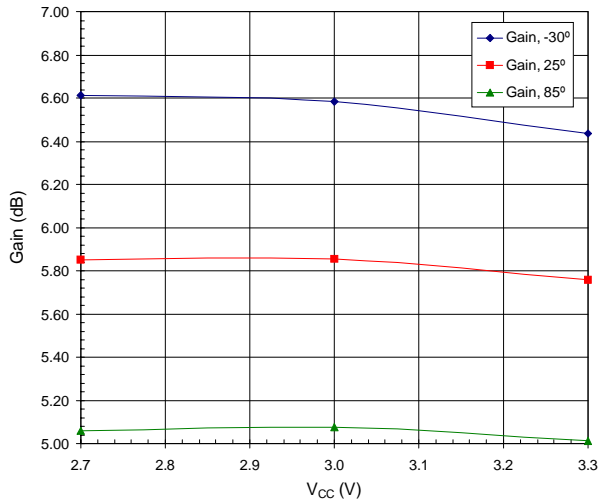

Mixer IF1, Low Gain Mode, LO@-10dBm

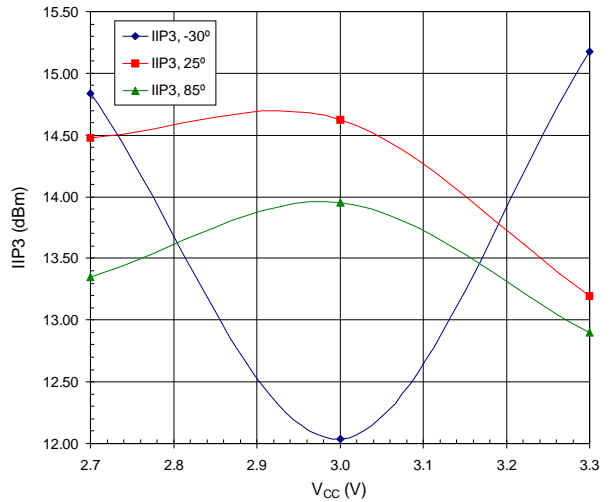

Mixer IF1, Low Gain Mode, LO@-10dBm

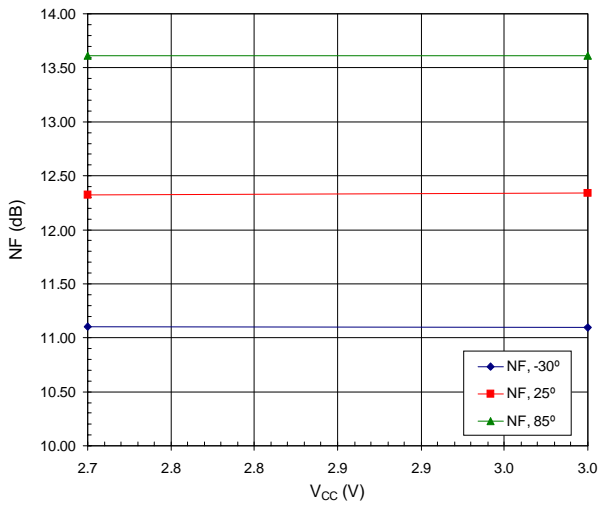

Mixer IF1, High Gain Mode, LO@-10dBm

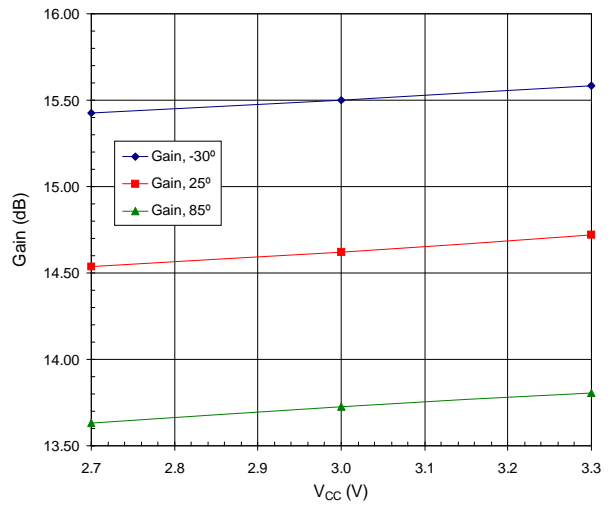

Mixer IF1, High Gain Mode, LO@-10dBm

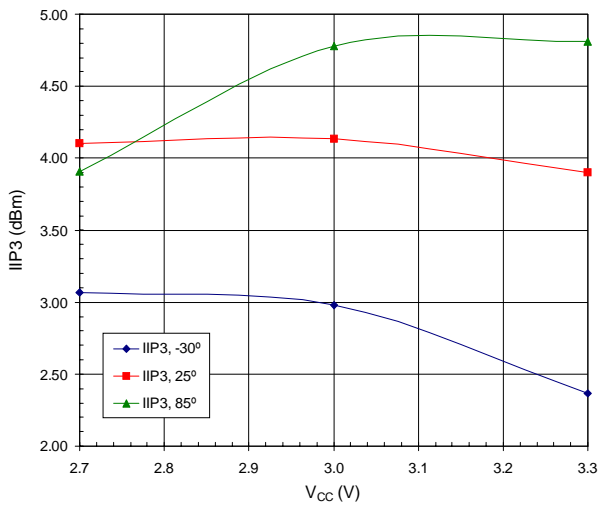

Mixer IF1, High Gain Mode, LO@-10dBm

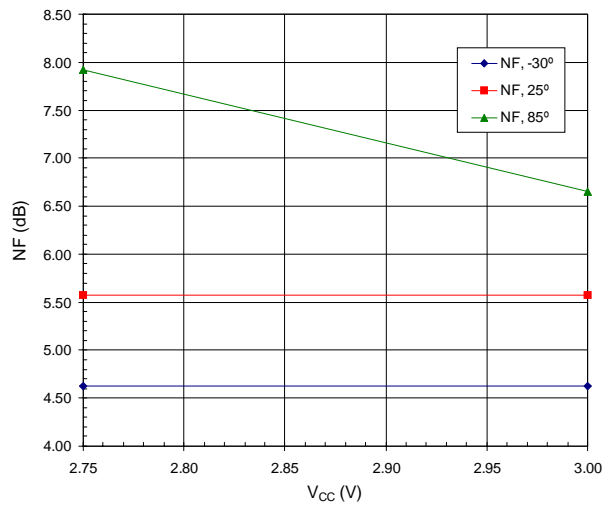

Mixer IF1, High Gain Mode, V<sub>CC</sub>@2.75V

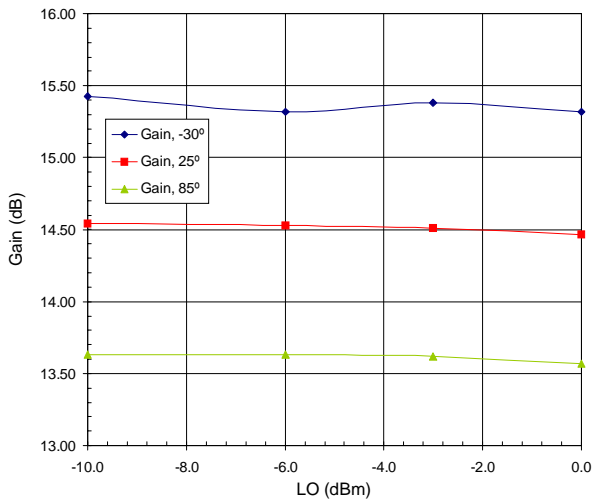

Mixer IF1, High Gain Mode, V<sub>CC</sub>@2.75V

